

# CANGAROO

---

Masaki Mori\*

for the CANGAROO team

\* *ICRR, The University of Tokyo*



Astrophysics of Ultra-High Energy Cosmic Rays, Photons, and  
Neutrinos (Miniprogram), May 19, 2005, KITP, UCSB

# “CANGAROO”

=

Collaboration of **A**ustralia and **N**ippon for a  
**G**amma **R**ay **O**bservatory in the **O**utback















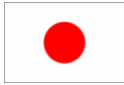

Woomera, South Australia

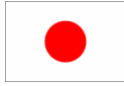

# CANGAROO team

---

- University of Adelaide 
- Australian National University 
- Ibaraki University 
- Ibaraki Prefectural University 
- Konan University 
- Kyoto University 
- STE Lab, Nagoya University 
- National Astronomical Observatory of Japan 
- Kitasato University 
- Shinshu University 
- Institute of Space and Astronautical Science 
- Tokai University 
- ICRR, University of Tokyo 
- Yamagata University 
- Yamanashi Gakuin University 

# Brief history of CANGAROO

---

- 1987: SN1987A
- 1990: 3.8m telescope
- 1990: ICRR-Adelaide Physics agreement
- 1992: Start obs. of 3.8m tel.
- 1994: PSR 1706-44
- 1998: SNR1006
- 1999: 7m telescope
- 2000: Upgrade to 10m
- 2001: U.Tokyo-U.Adelaide agreement
- 2002: Second and third 10m tel.
- 2004: Four telescope system

# JANZOS project in New Zealand

Japan Australia New Zealand  
Observation of Supernova 1987A



Shower particle detector array

+

Three Fixed Cherenkov telescopes

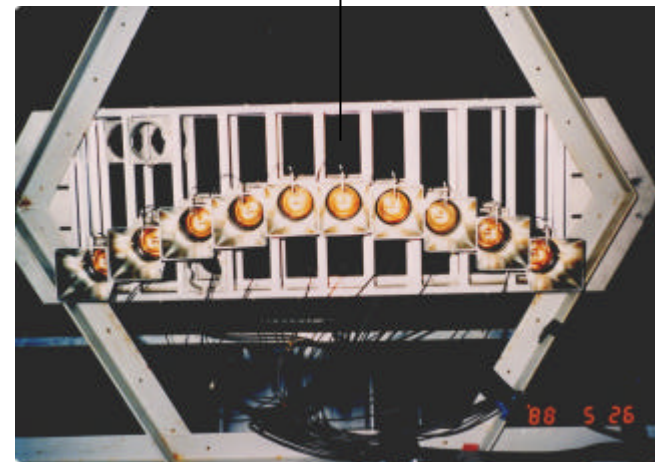
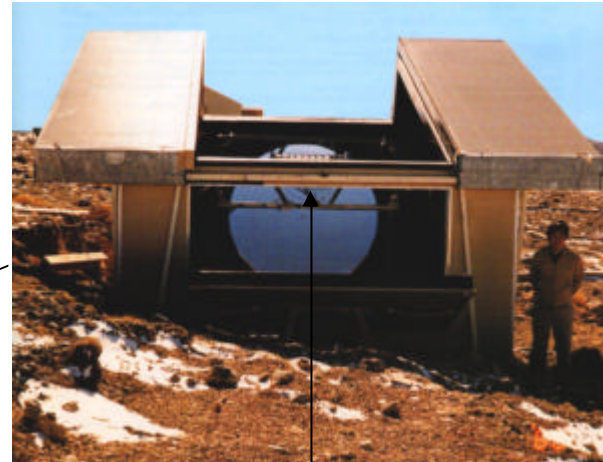

# Why Woomera?

---

- ❑ NZ: too wet, not many clear nights
- ❑ Woomera:
  - Former rocket range and prohibited area...infra-structure and support
  - Adelaide group was operating BIGRAT



ELDO rocket Launch site in '60s

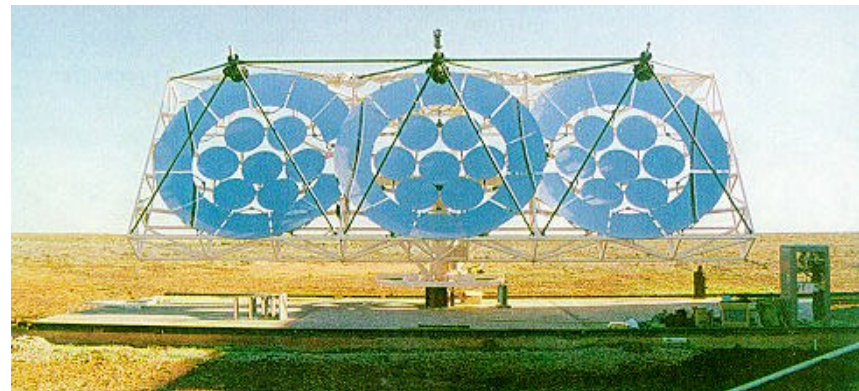

BIGRAT

(Bicentennial Gamma Ray Telescope)

# 3.8m telescope: ex. Lunar ranging

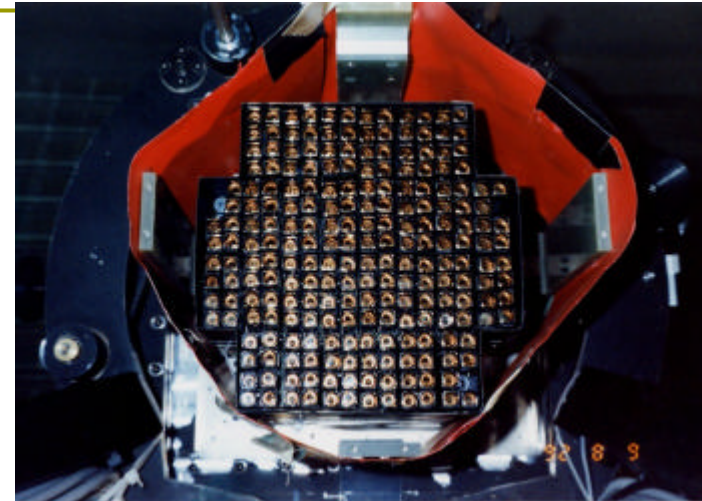
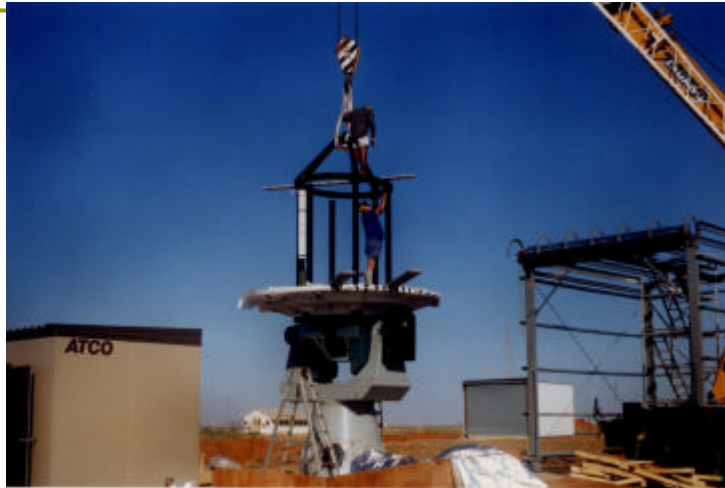

Imaging camera at the prime focus



Tadashi Kifune & John Patterson 7

# CANGAROO-I results: summary

	Signal	Publish	H.E.S.S.
❑ SNR/Pulsar Crab	○	ApJL'94	○
❑ SNR SN1006	○	ApJL'98	↓
❑ SNR RX J1713.7-3946	○	A&AL'00	○
❑ SNR W28	↓	A&A'00	
❑ Pulsar PSR 1706-44	○	ApJL'95	↓
❑ Pulsar Vela	○	ApJL'97	↓
❑ Pulsar PSR 1509-58	△	ApJ'00	○
❑ Pulsar PSR 1055-52	↓	(Ph.D.'97)	
❑ AGNs: PKS0521-365, EXO0423.4-0840, PKS2005-489, PKS2316-423	↓	A&A'98	
❑ Blazars: PKS0548-322, PKS2005-489 and PKS2155-304	↓	A&A'99	
❑ Radio galaxy Cen A	↓	(Proc.'99)	

Signal: ○ detected, ↓ upper limit, △ marginal



# PSR 1509-58/MSH15-52

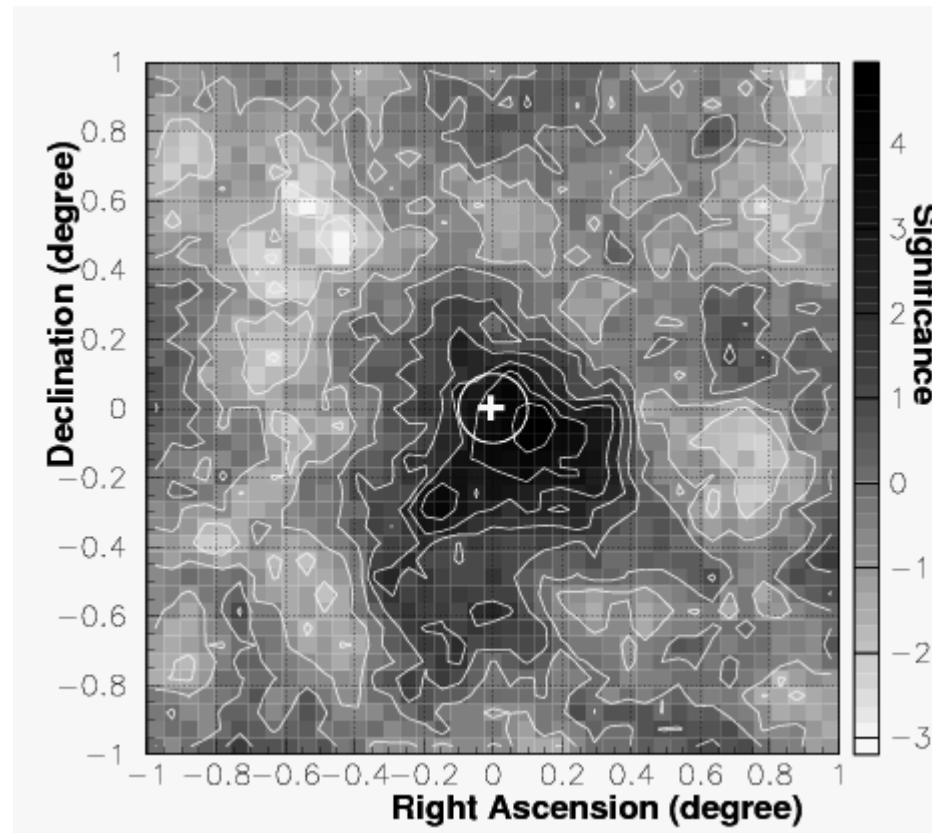
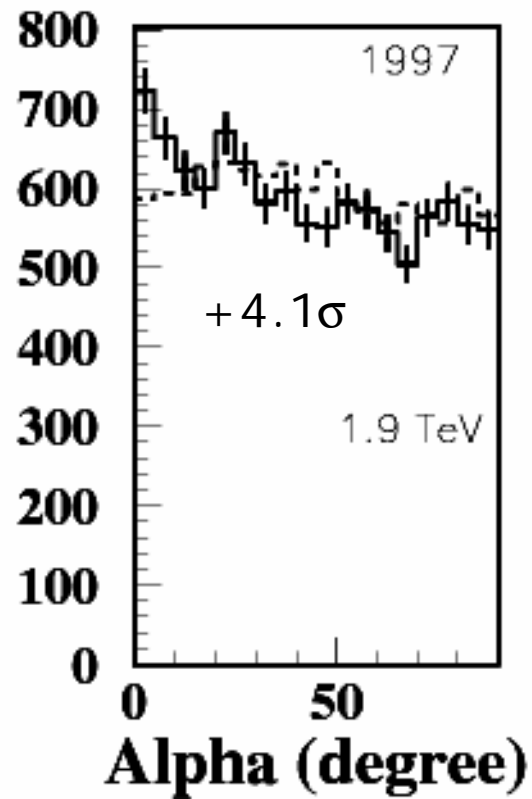

Sako et al., ApJ, 537(2000) 422

# CANGAROO-II telescope

- ❑ Upgraded in 2000 from 7m telescope completed in 1999
- ❑ 114 x 80cm CFRP mirror segments  
*(first plastic-base mirror in the world!)*
- ❑ Focal length 8m
- ❑ Alt-azimuth mount
- ❑ 552ch imaging camera
- ❑ Charge and timing electronics



(March 2000)

# CANGAROO-II & -III

## CANGAROO-II

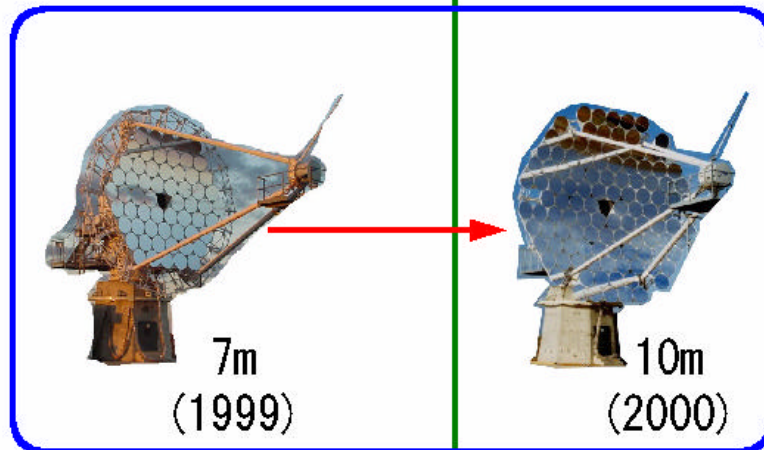

## CANGAROO-III

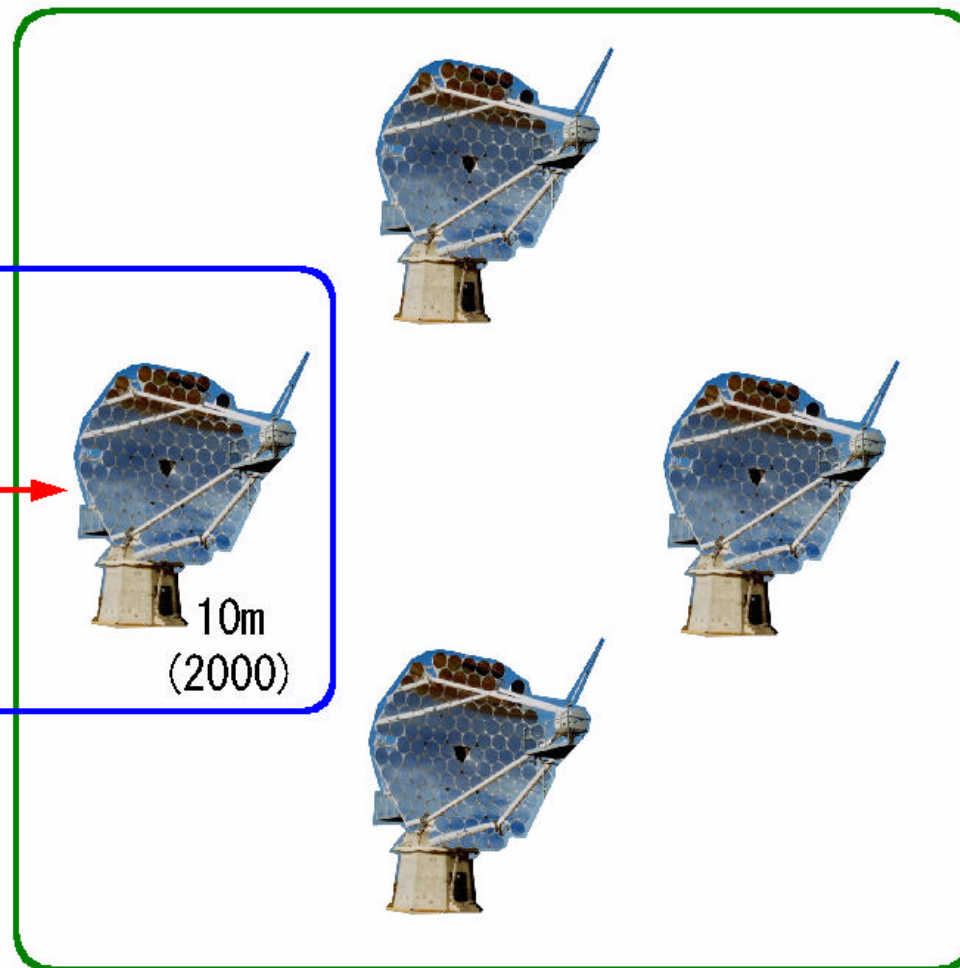

# CANGAROO-II results: summary

---

	Signal	Publish	H.E.S.S.
❑ SNR RX J1713.7-3946	○	Nature '02	○
❑ Blazar Mrk421	○	ApJL'02	○
❑ Starburst galaxy NGC253	○	AAL'03	↓
❑ SNR SN1987A	↓	ApJL'03	
❑ Galactic Center	○	ApJL'04	○
❑ Pulsar binary PSR 1259-63/SS2883	↓	ApJ'04	○
❑ SNR RX J0852.0-4622 (Vela Jr.)	○	ApJL'05	○

Signal: ○ detected, ↓ upper limit, Δ marginal

# SNR RX J1713.7-3946

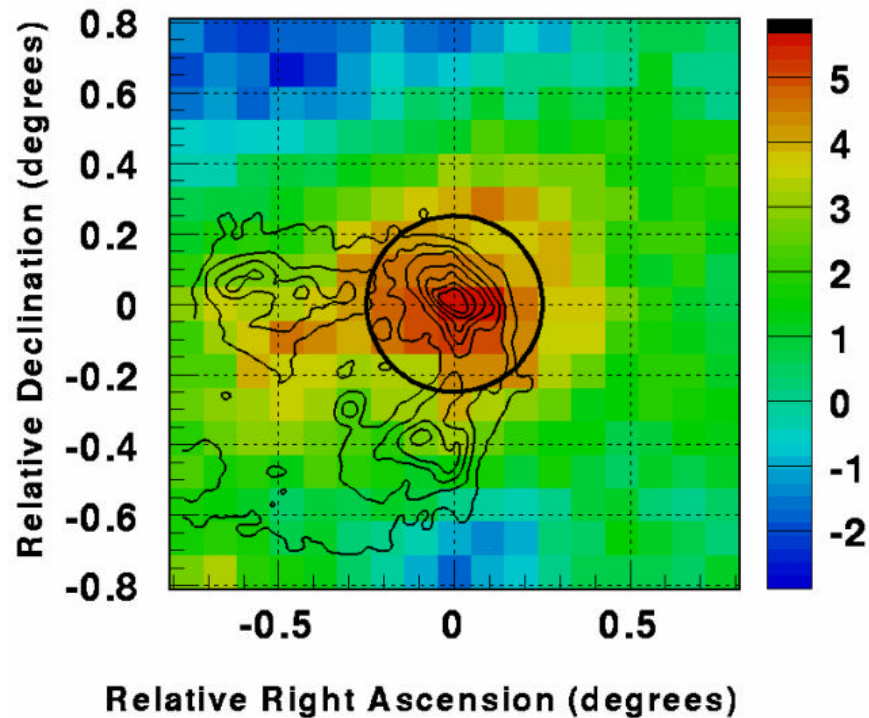

CANGAROO-I (Muraishi et al., 2000)

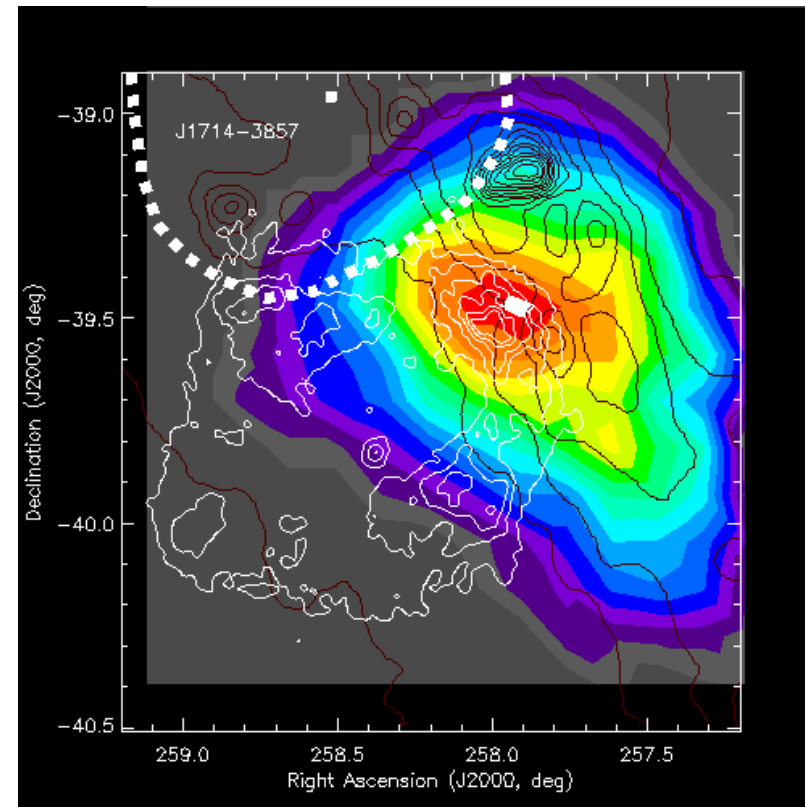

CANGAROO-II (Enomoto et al., 2002)

# Spectrum of RX J1713.7-3946

Reimer & Pohl, A&A 390 (2002) L43

Butt et al., Nature 418 (2002) 489

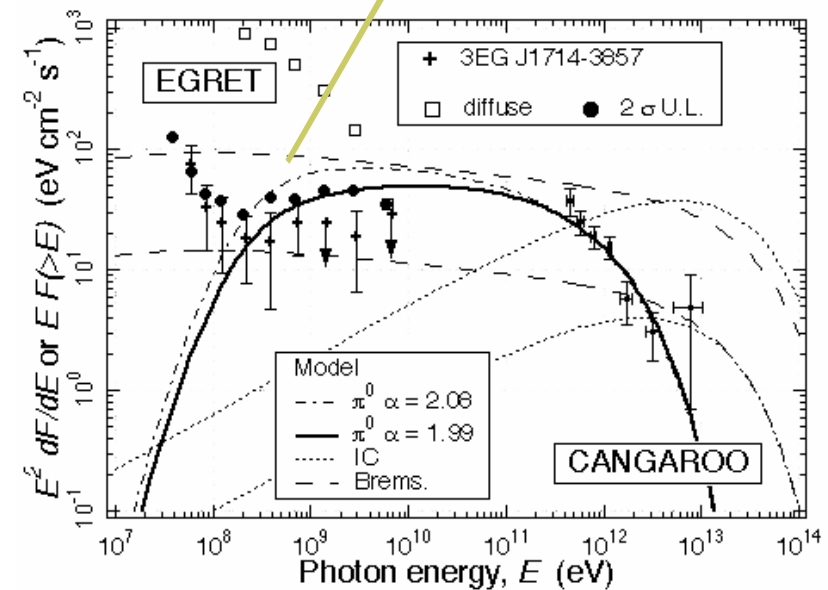
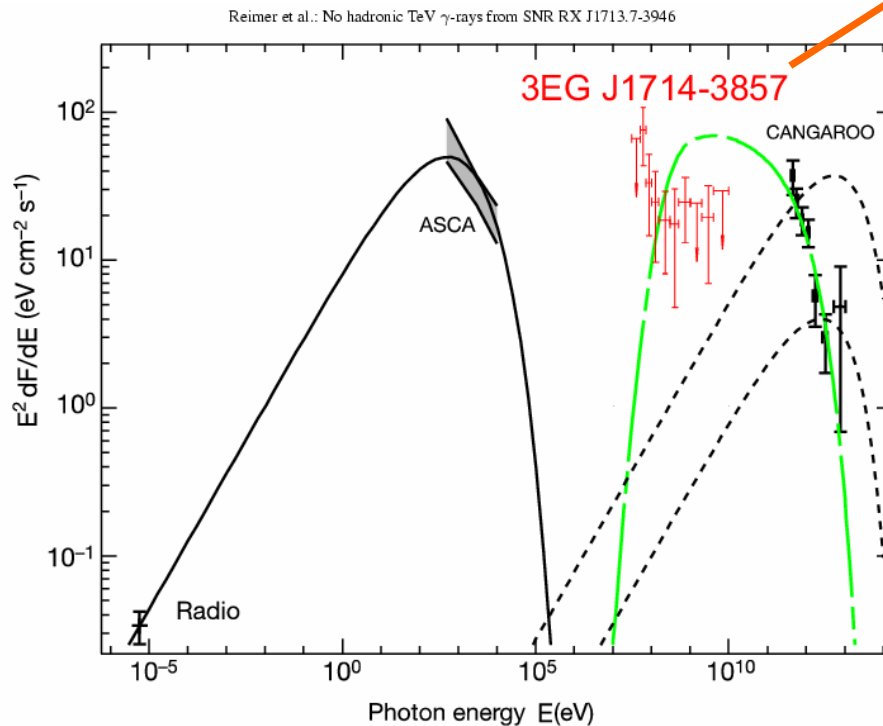
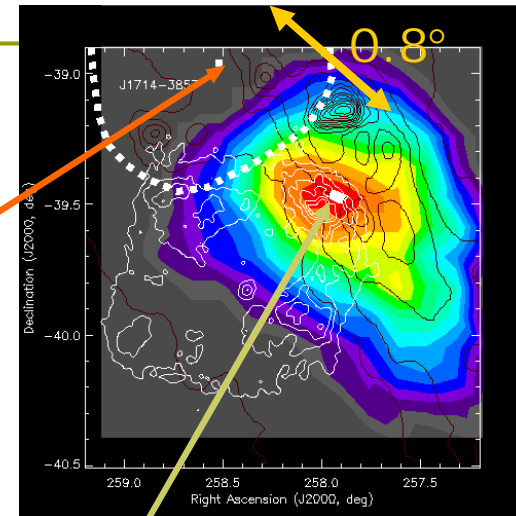

# Galactic Center/Sgr A\*

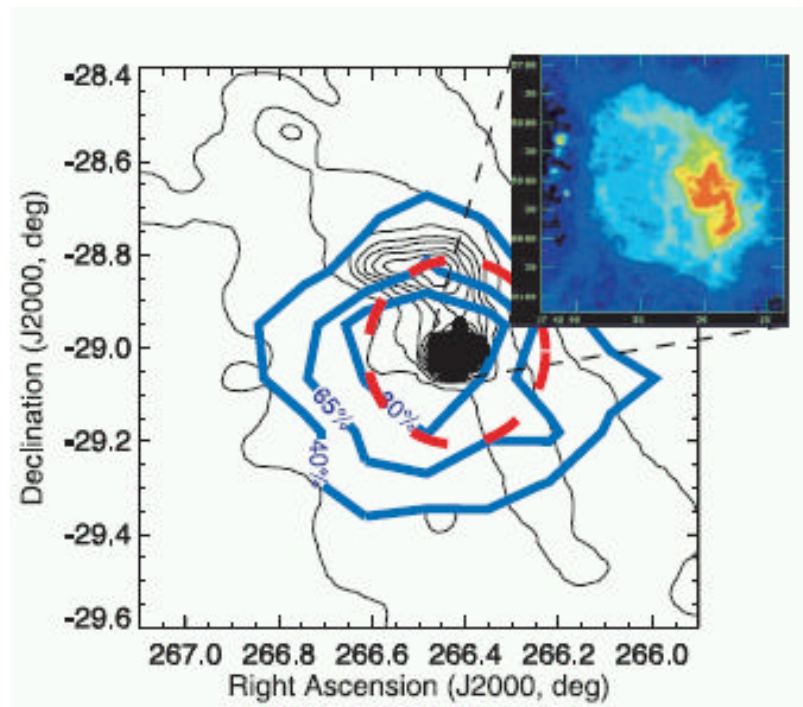

CANGAROO-II (Tsuchiya et al., 2004)

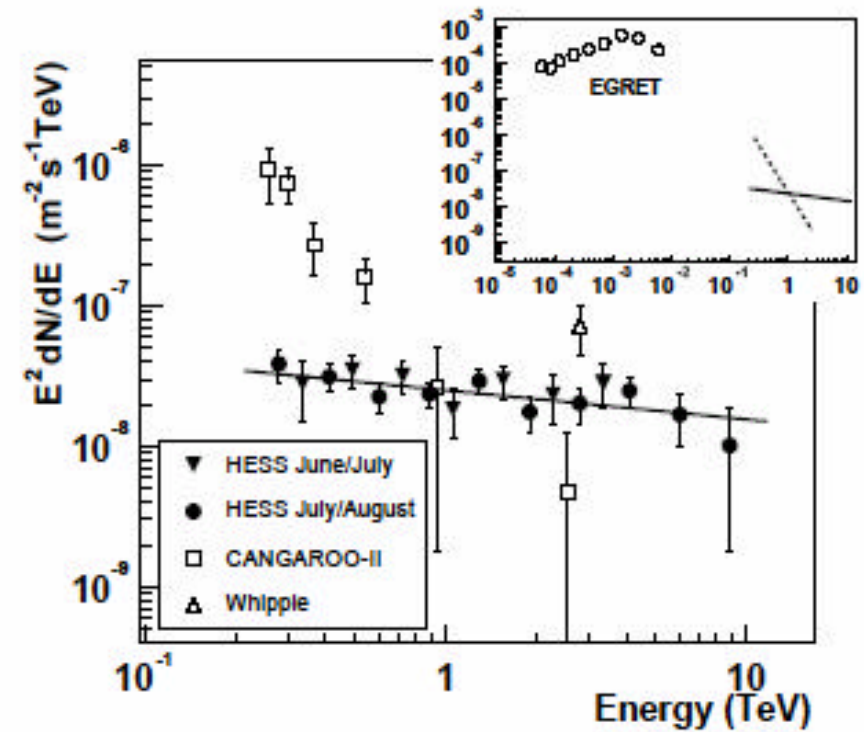

Aharonian et al., AA 425 (2004) L13

# Dark matter signal from Sgr A\*?

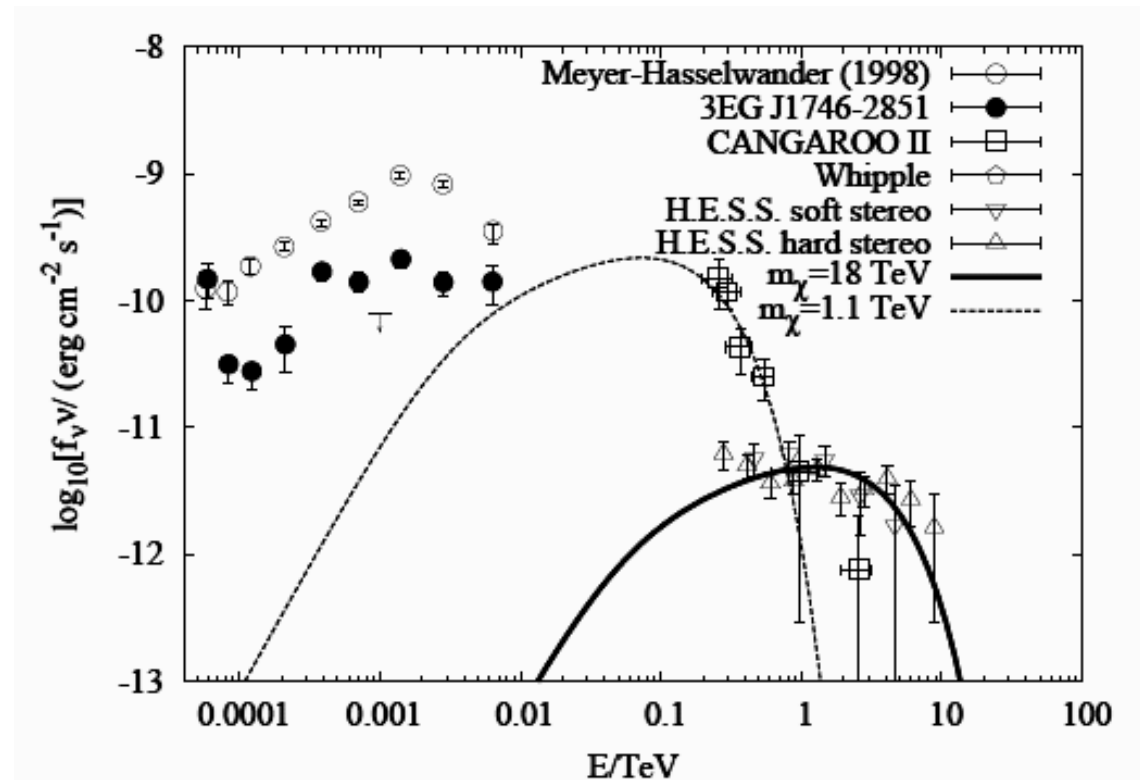
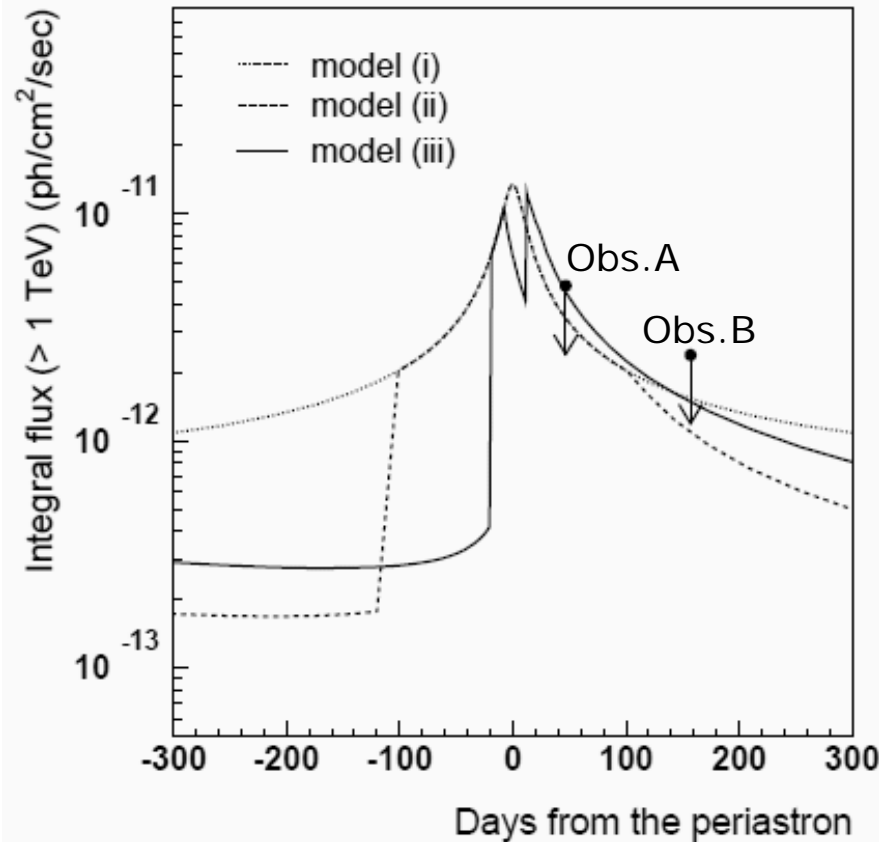

Fig. 2. A summary of data and best-fit models for WIMP annihilation from the Galactic center: H.E.S.S. (open triangles), CANGAROO (open boxes), EGRET (solid and open circles), 10m Whipple telescope of the VERITAS collaboration (solid diamond).



# PSR 1259-63/SS2883



- (i) aligned disc to the orbital plane and interaction throughout the orbit
- (ii) mis-aligned disc and interaction in the  $\sim 200$ -day period around periastron ( $t$ ), during which the radio emission is depolarized
- (iii) mis-aligned disc and interaction in two short periods,  $[(t - 18 \text{ d}) \sim (t - 8 \text{ d})]$  and  $[(t + 12 \text{ d}) \sim (t + 2 \text{ d})]$

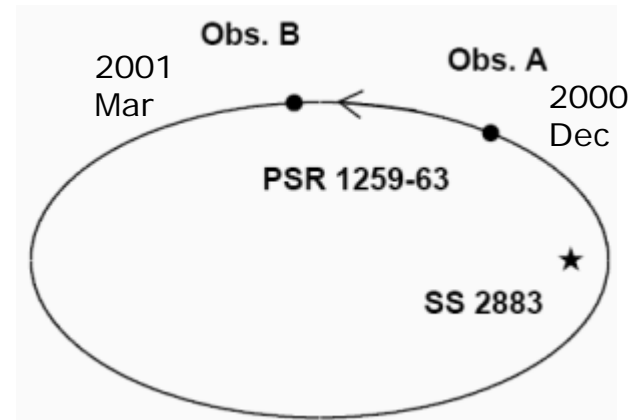

# SNR RX J0852.0-4622

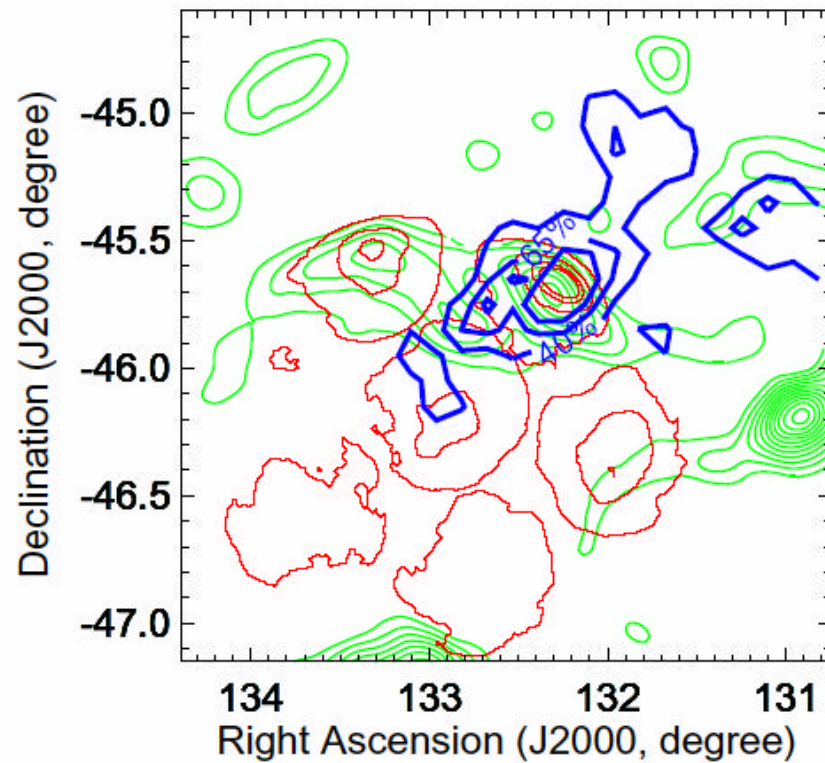

CANGAROO-II: Katagiri et al.,  
ApJ, 619, (2005) L163

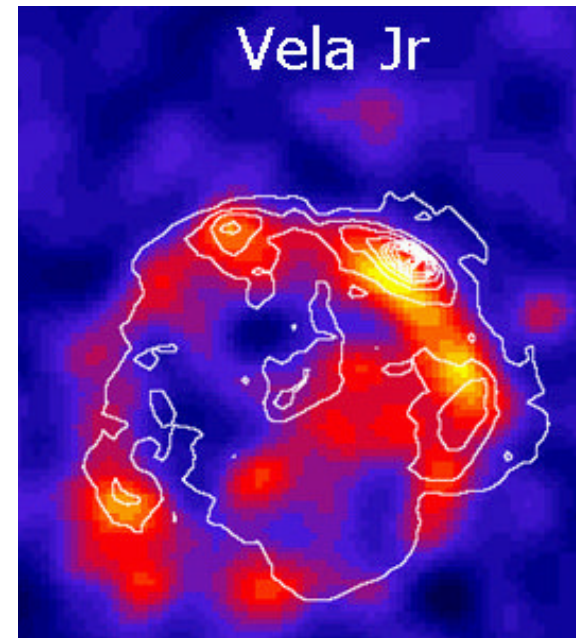

H.E.S.S. (Hofmann,  
Cherenkov2005)

# RX J0852.0-04622 spectrum

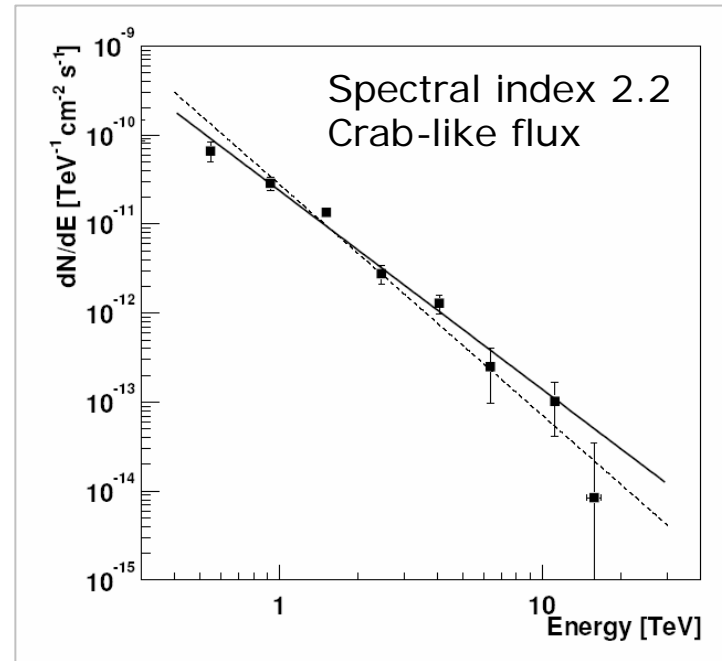
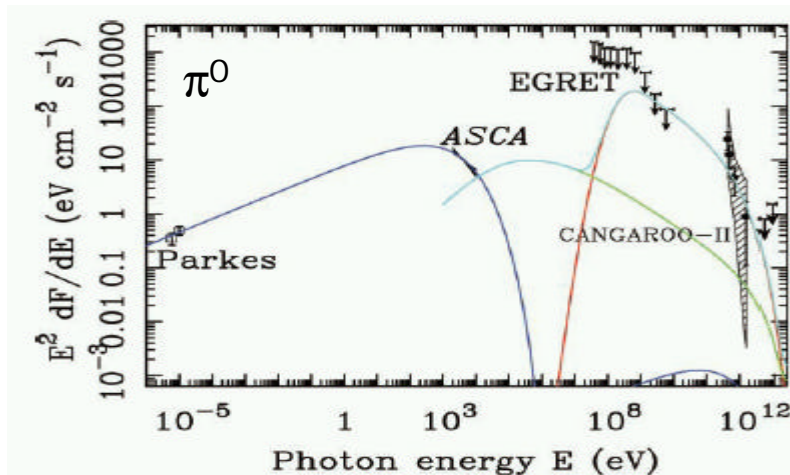
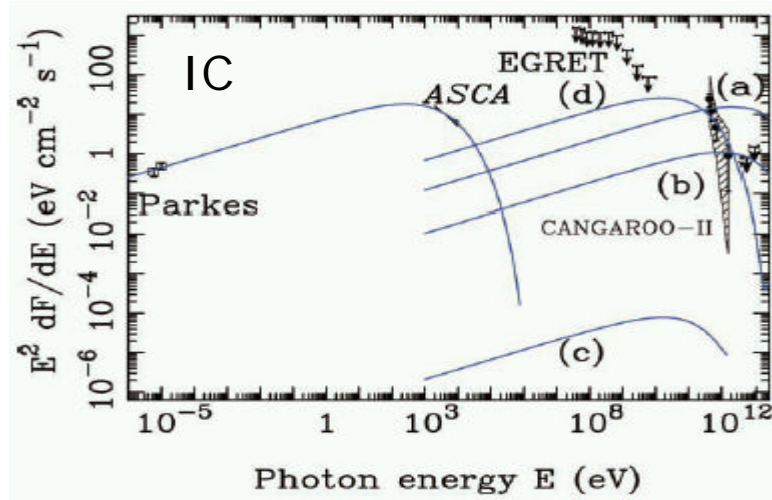

H.E.S.S. (Hofmann,  
Cherenkov2005)

CANGAROO-II: Katagiri et al., ApJ,  
619, (2005) L163

# Woomera: 2004 March

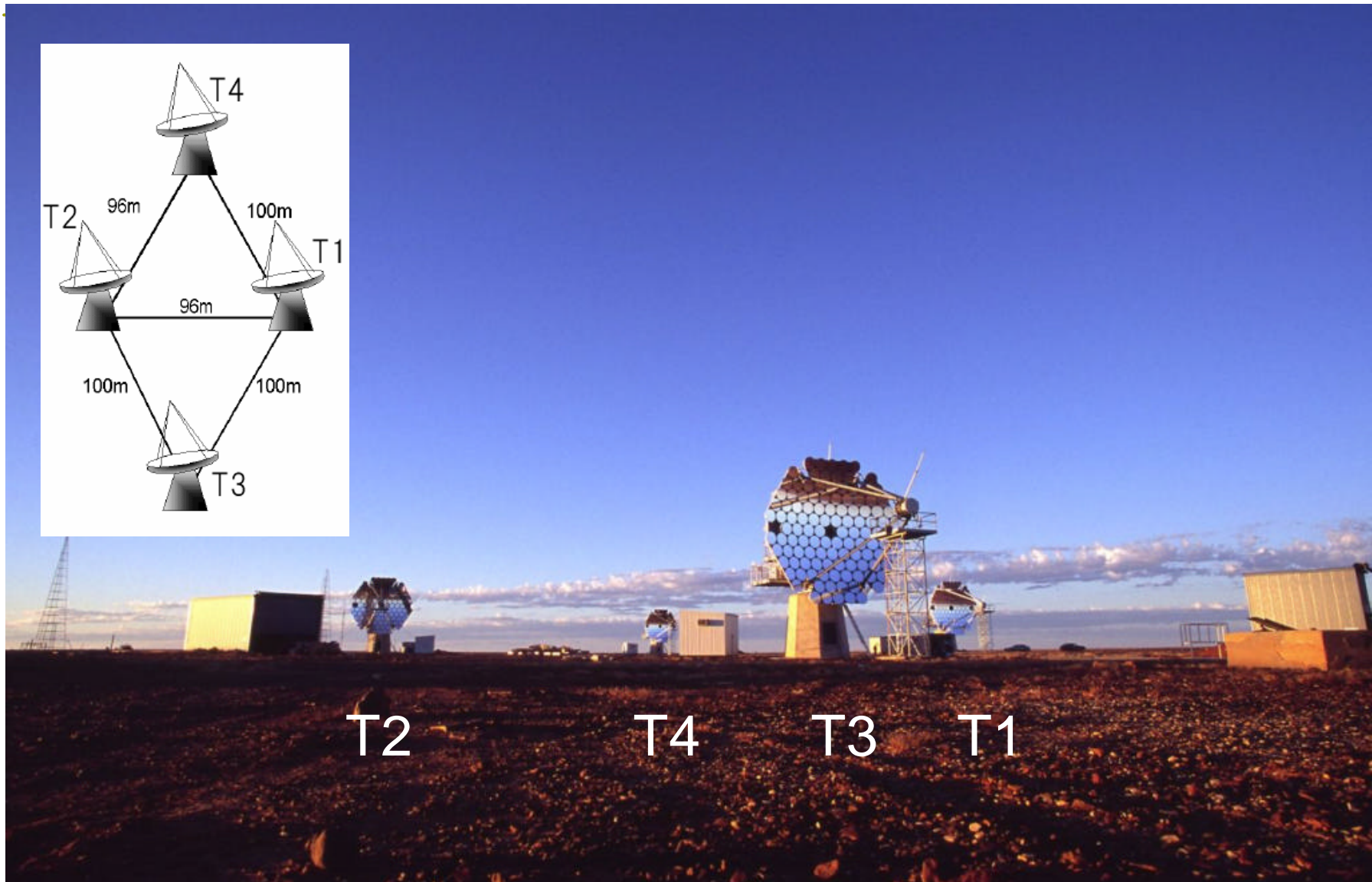
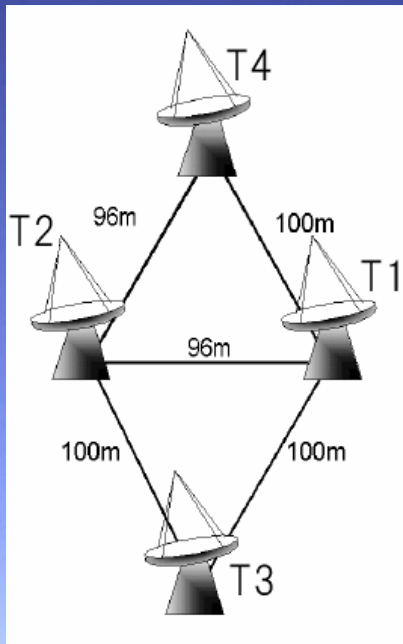

# Basic specifications of telescopes

- Location:
  - $31^{\circ}06'S$ ,  $136^{\circ}47'E$
  - 160m a.s.l.
- Telescope:
  - $114 \times 80\text{cm}\phi$  FRP mirrors (57m<sup>2</sup>, Al surface)
  - 8m focal length
  - Alt-azimuth mount
- Camera:
  - T1: 552ch (2.7° FOV)
  - T2,T3,T4: 427ch (4° FOV)
- Electronics:
  - TDC+ADC

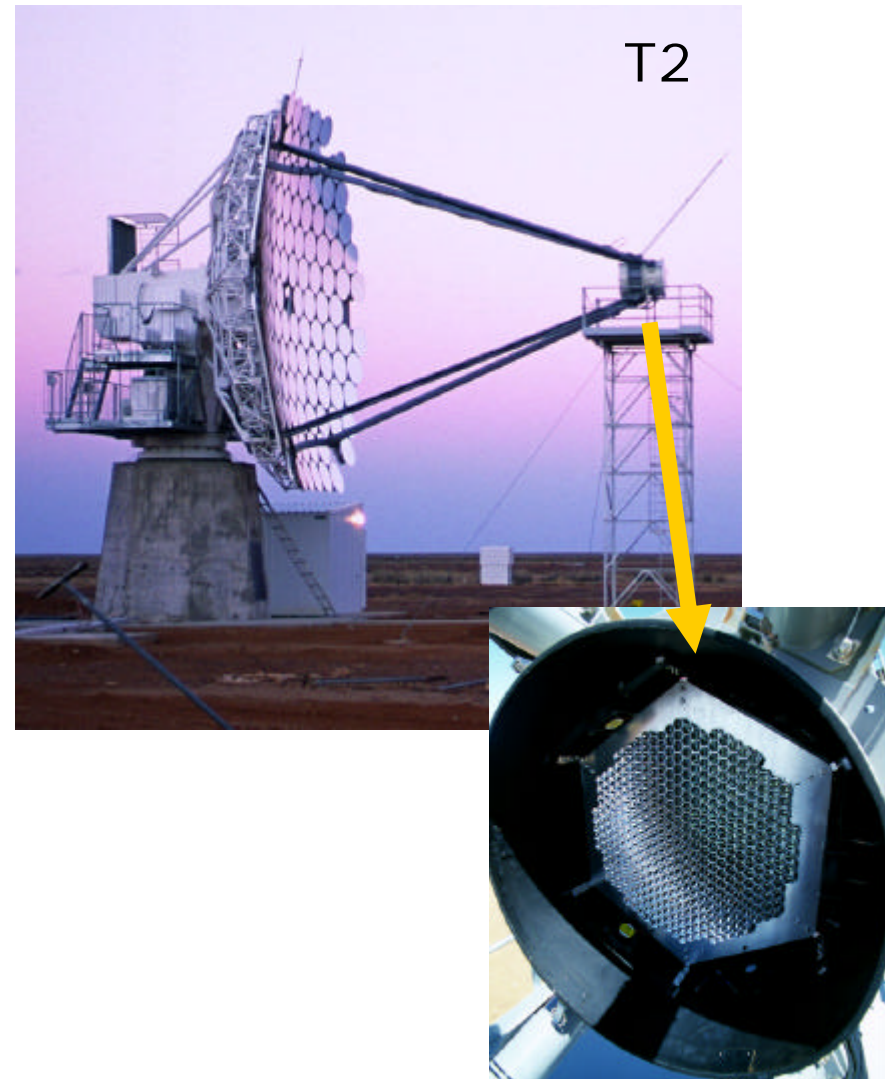

# Construction of CANGAROO-III

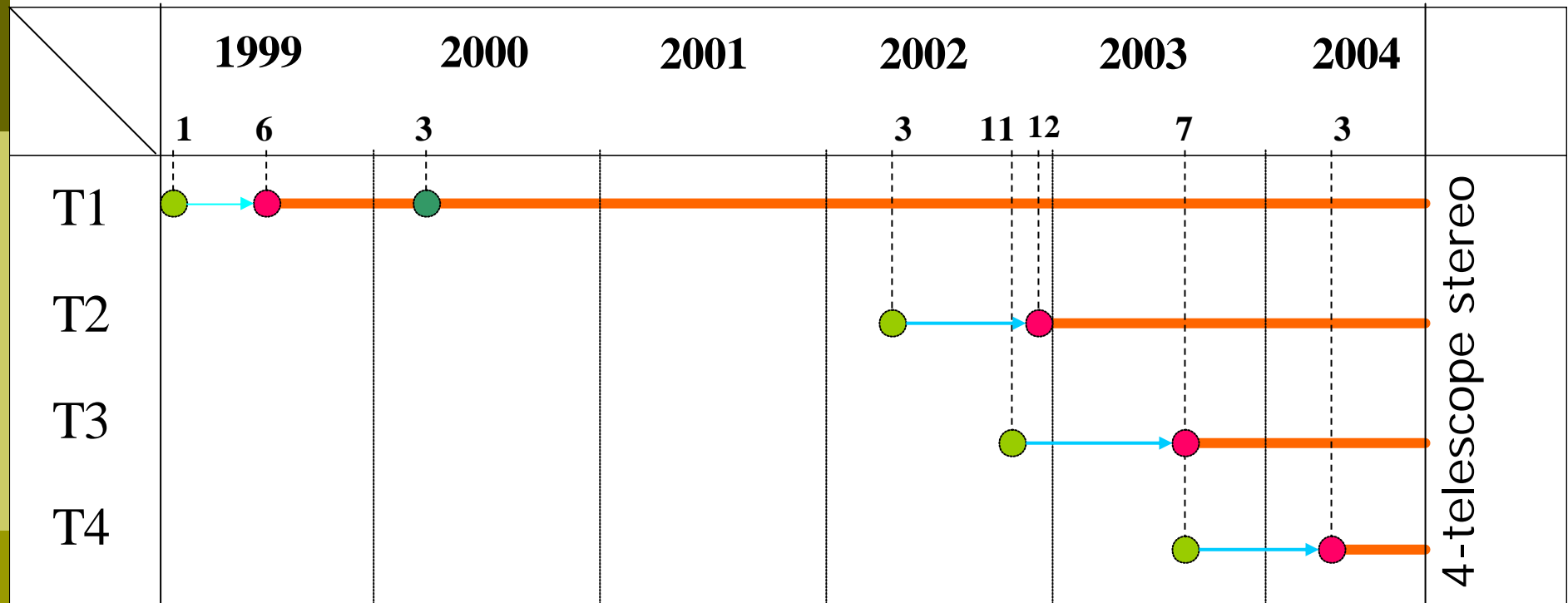

- : Construction
- : Observation start
- : Expansion to 10m
- : Observation
- : Tuning

# Sample of 4-fold stereo events

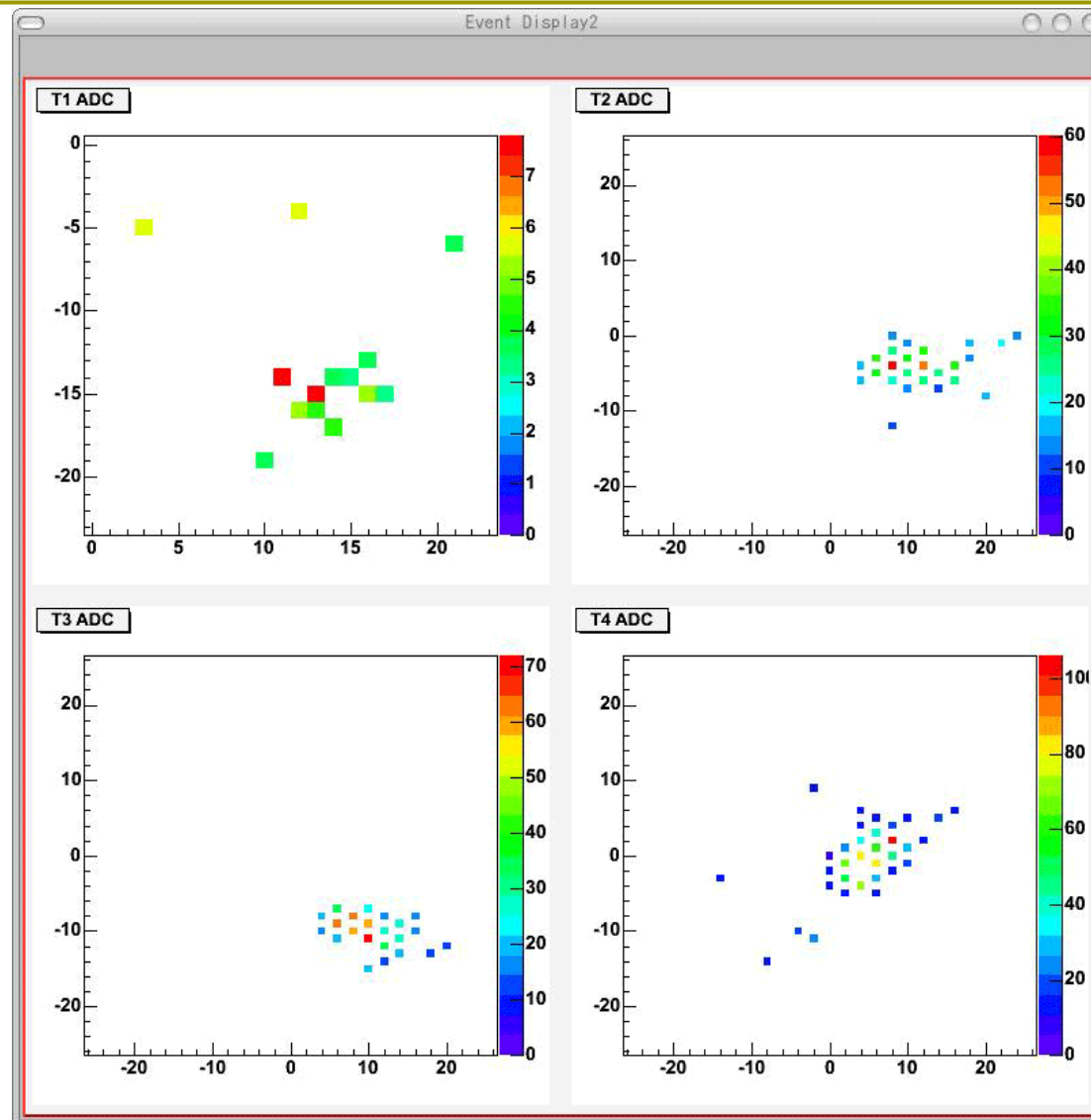

Data:  
2004  
March

# Stereo analysis: still underway & in progress

---

- ❑ Inconsistency with H.E.S.S results on some sources
  - ⇒ New observations with CANGAROO III
  - Efforts for advanced analysis procedures
- ❑ Measure more optical parameters
  - CCD measurements of spotsizes and stars
- ❑ Use muons for calibration
  - Tune Monte Carlo simulation
- ❑ Use the Crab as the standard candle
  - Flux obtained with Monte Carlo simulation is compared with those reported by other groups
- ❑ Independent teams within the collaboration are working:
  - Hereafter, referred to as Teams A, B, C ...
  - Results, especially detections, are double-checked



# H.E.S.S. results

W.Hofmann, Cherenkov2005



## H.E.S.S. and the "known" sources

Southern hemisphere TeV sources

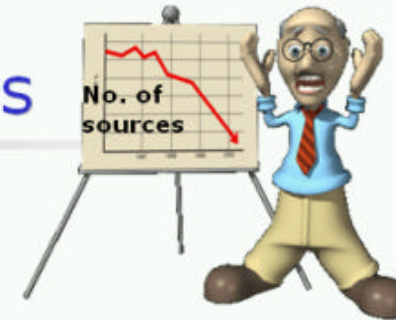

Object	Current status
PSR 1706-44	H.E.S.S.: limit well below old flux <small>A&amp;A</small>
Vela pulsar	H.E.S.S.: limit well below old flux
SN 1006	H.E.S.S.: limit well below old flux <small>A&amp;A in press</small>
NGC 253	H.E.S.S.: limit well below old flux <small>to be subm.</small>
Gal. center	H.E.S.S.: $>30 \sigma$ , spectrum differs <small>A&amp;A</small>
RX J1713	H.E.S.S.: $>30 \sigma$ , spectrum & flux similar <small>Nature</small>
PKS 2155	H.E.S.S.: $>100 \sigma$ , variable source <small>A&amp;A</small>

# Star tracking

Star position error observed by a CCD camera

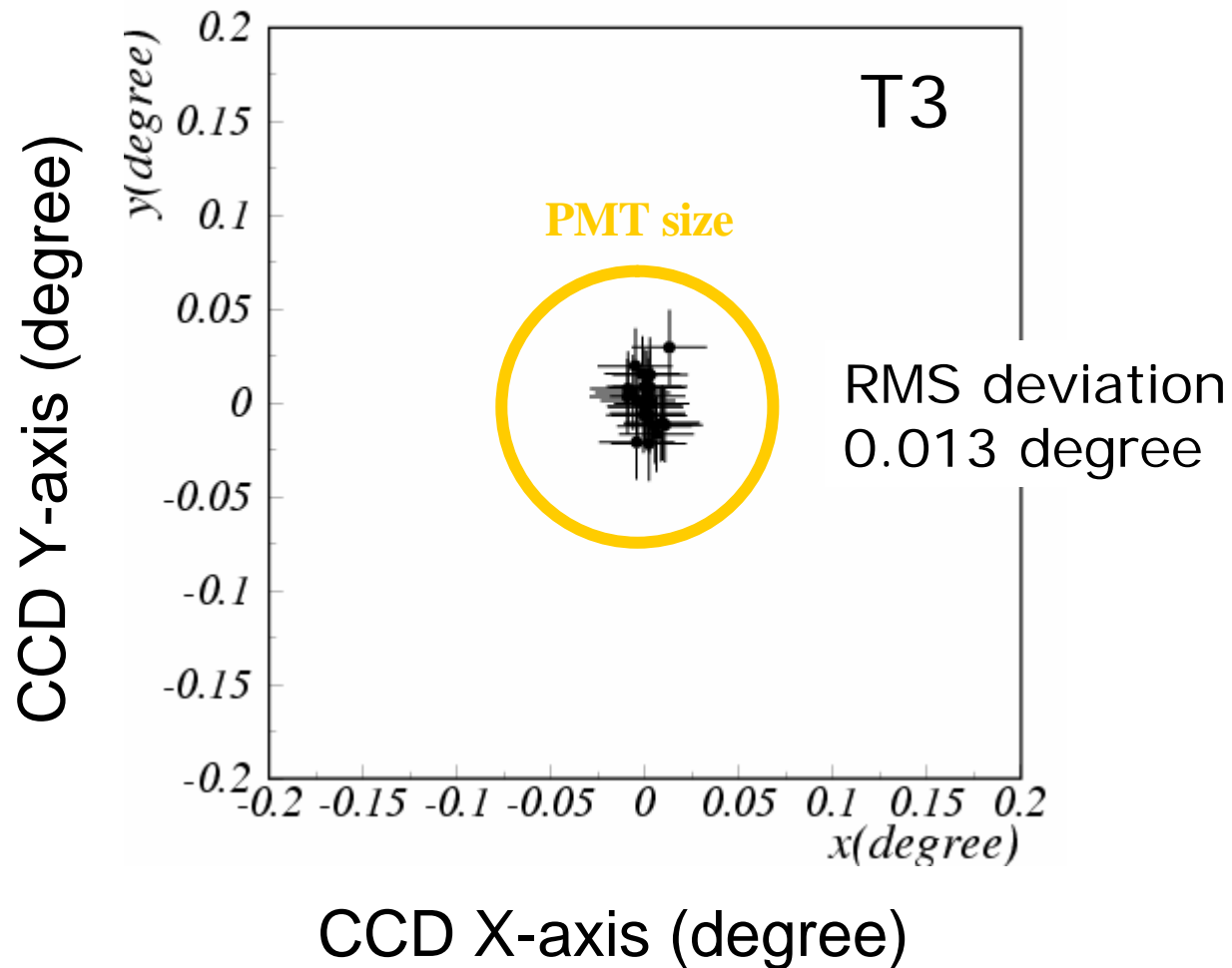

# Spot size

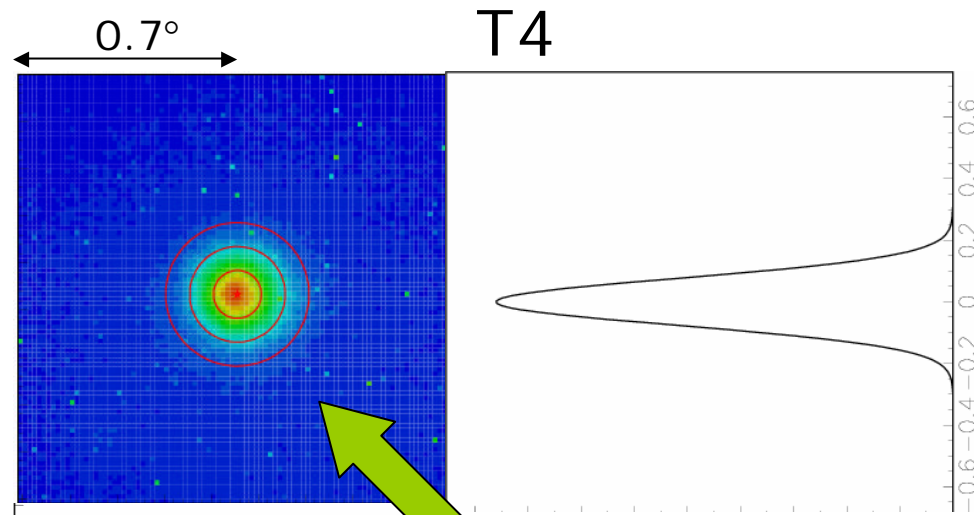

Y (vertical)

Point Spread Function (FWHM)

T1: 0.20°

T2: 0.21°

T3: 0.14°

T4: 0.16°

(measured at construction time)

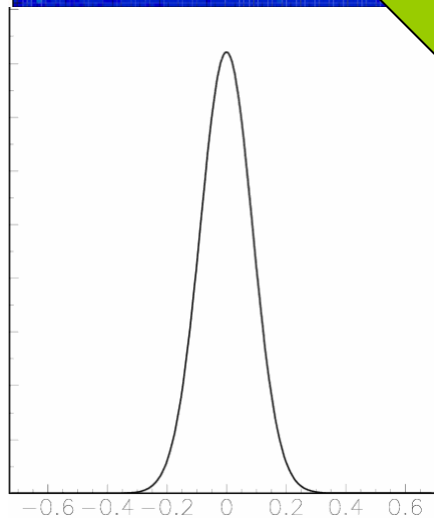

X (horizontal)

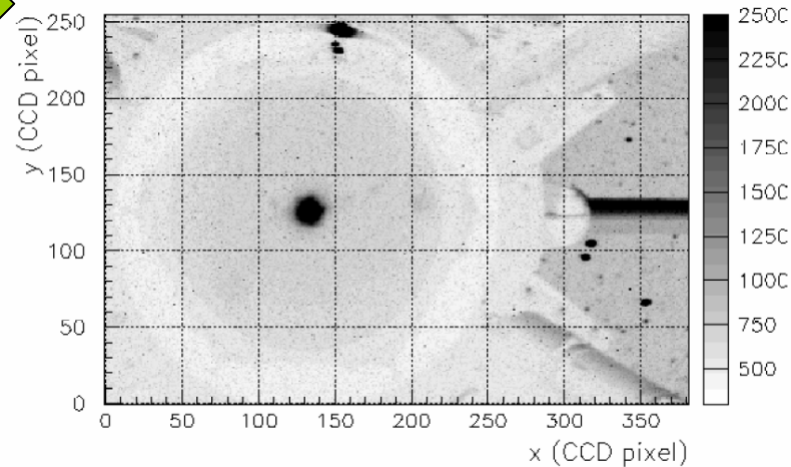
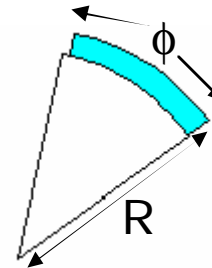

Image of a star on camera observed by a CCD camera

# Muon events (1)

- Selected by
  - 1) clustering
  - 2)  $R \times \phi$  (arc length)  $> 2 \text{deg} \cdot \text{rad}$
  - 3) Small  $\chi^2$  (good fit)



Data: 2004 March

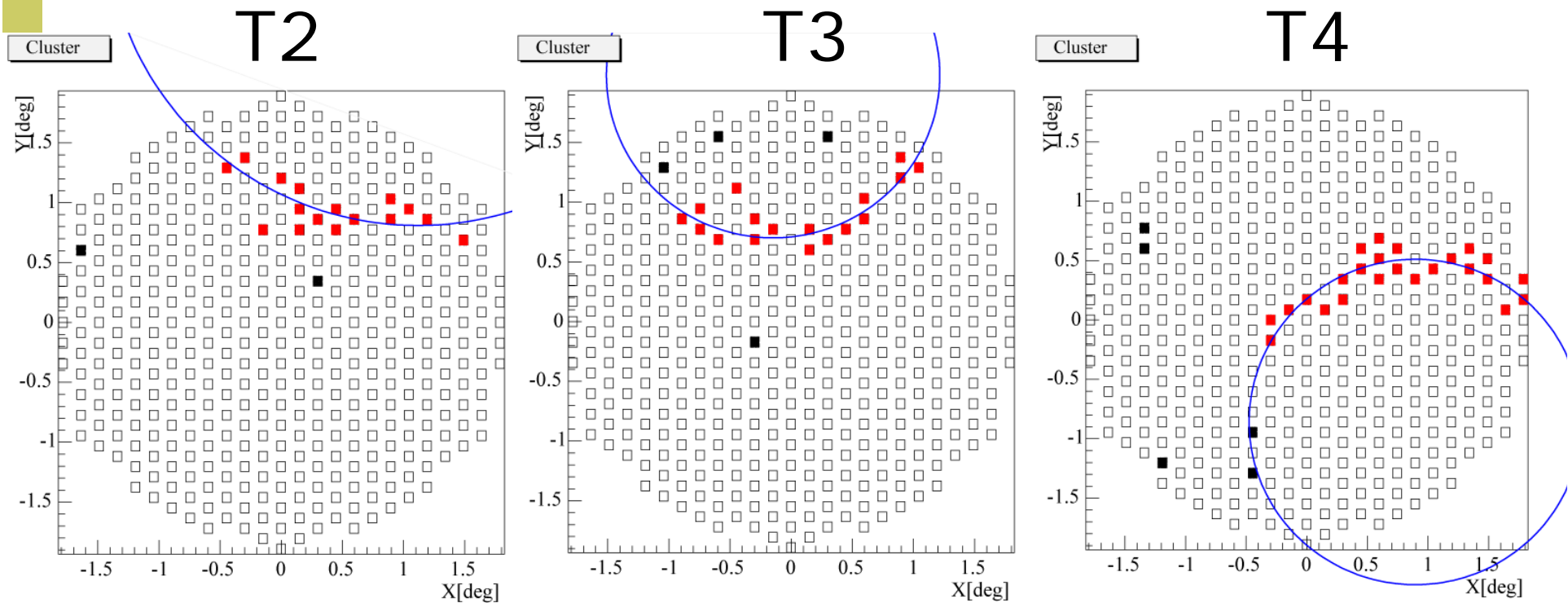

# Muon events (2)

- T4  $r[m] \approx 8 \tan q_c$   
on the focal plane

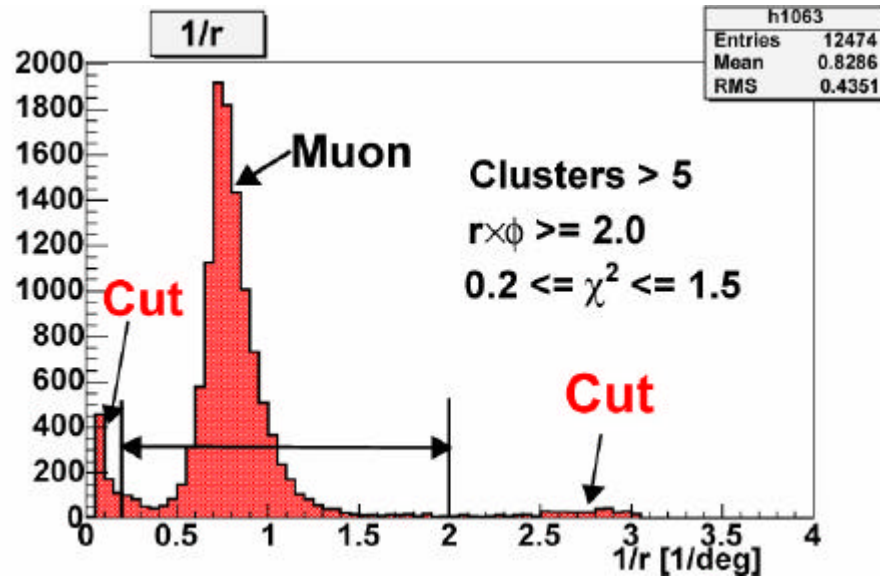

Curvature Distribution

1-7GeV :  $1/r \geq 1.0$  [1/deg]  
> 7GeV :  $1/r < 1.0$  [1/deg]

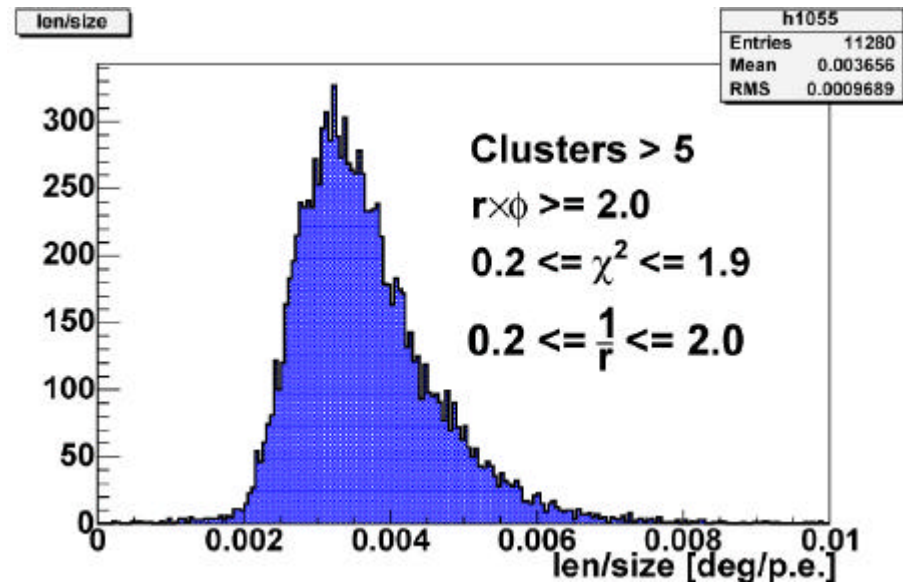

Length/size Distribution

Monte Carlo simulation

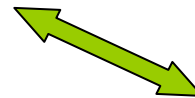

# Muon parameters compared with Monte Carlo

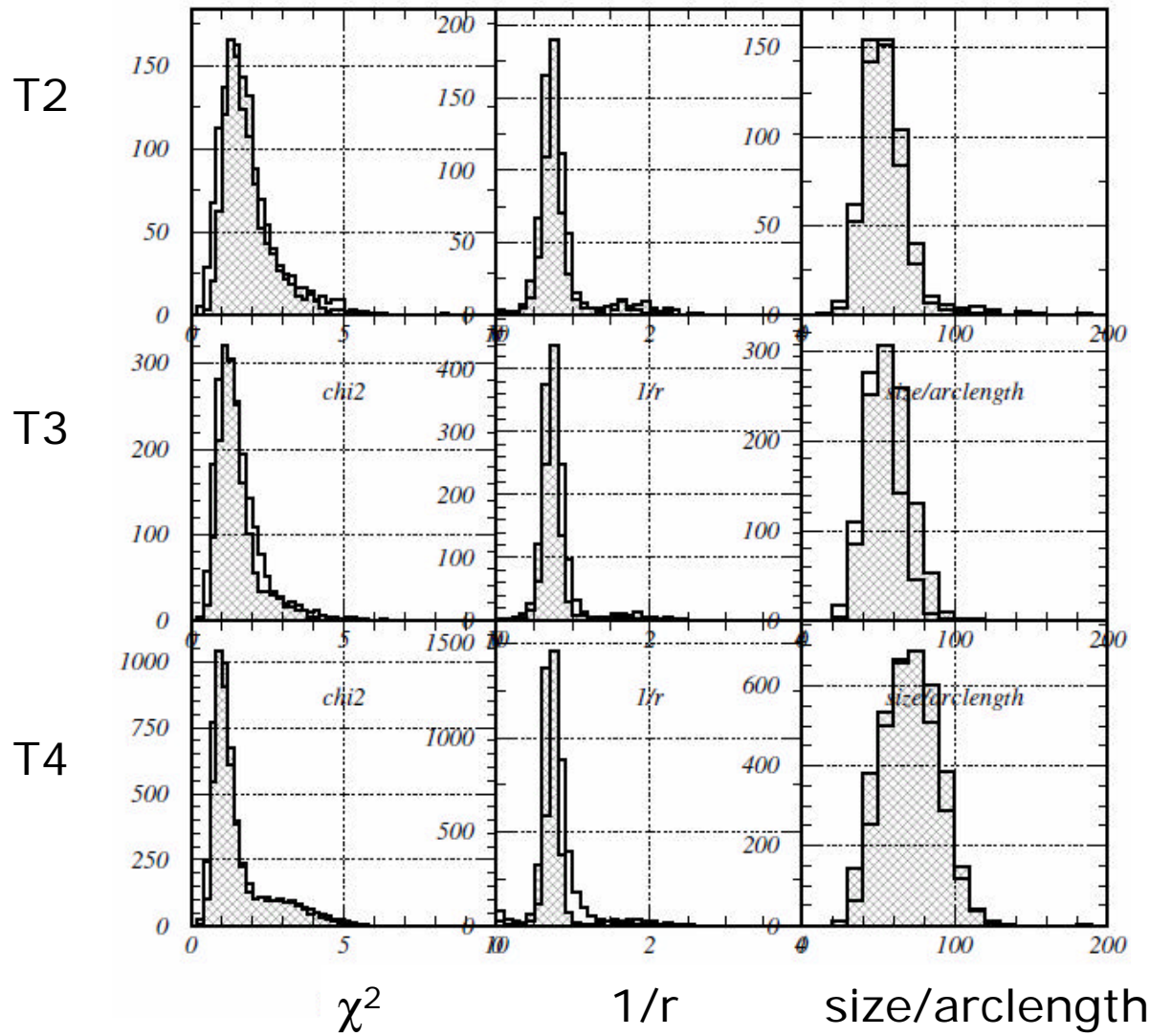

Histogram: data  
 Hatched: M.C.

$\chi^2$ : for ring fitting  
 (sensitive to spot size)  
 r: curvature radius  
 (~0.8 for  $v/c=1$ )  
 Size/arclength  $\propto$   
 total light collection  
 efficiency

# Time variation of Size/Arclength

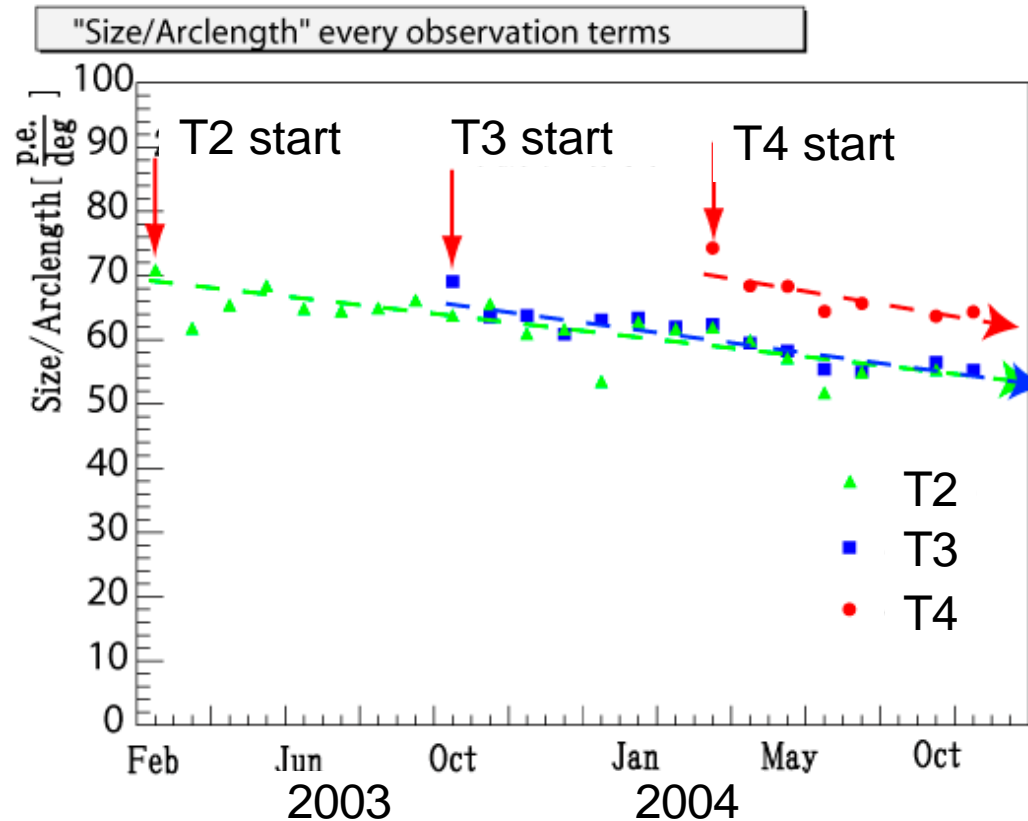

- Monitor of total light conversion efficiency

- Gradually, *Size/Arclength* is decreasing (~5% / year)

- Mirror degradation due to dust etc.

# Stereo observation

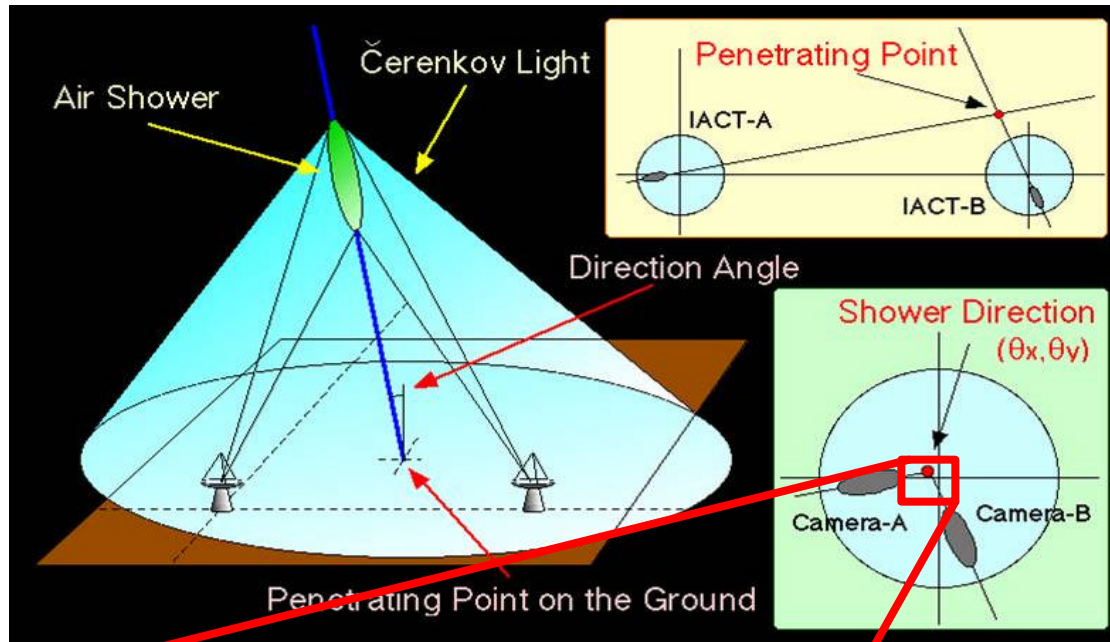

Angular resolution

0.25deg  $\rightarrow$  0.1 deg

Energy resolution

30%  $\rightarrow$  15%

Better S/N (no local muons)

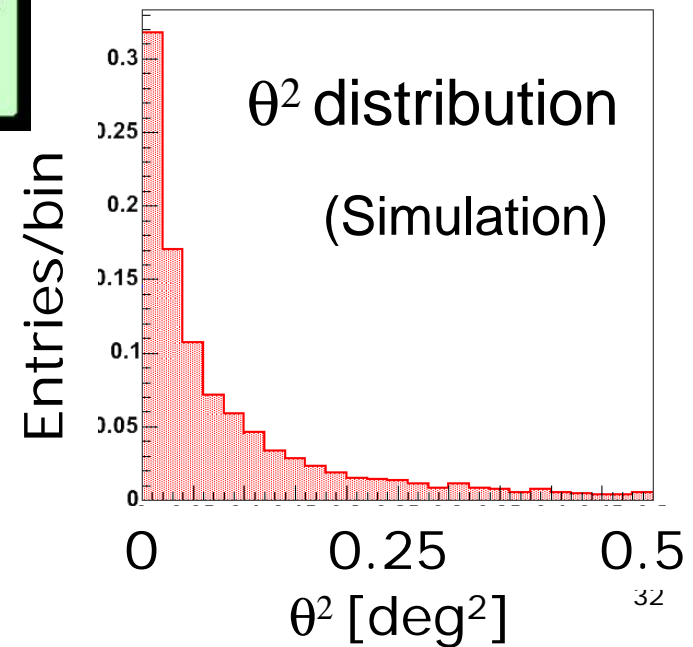
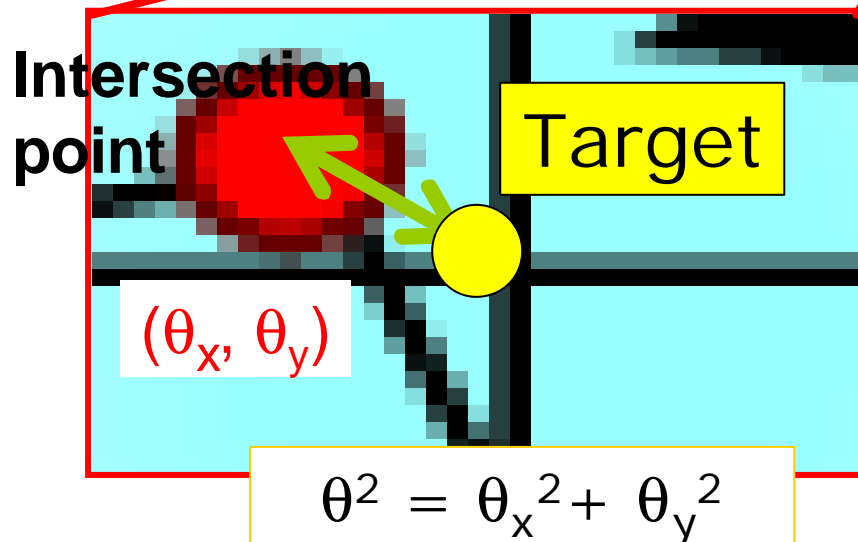



# Unfortunate situation for the Crab

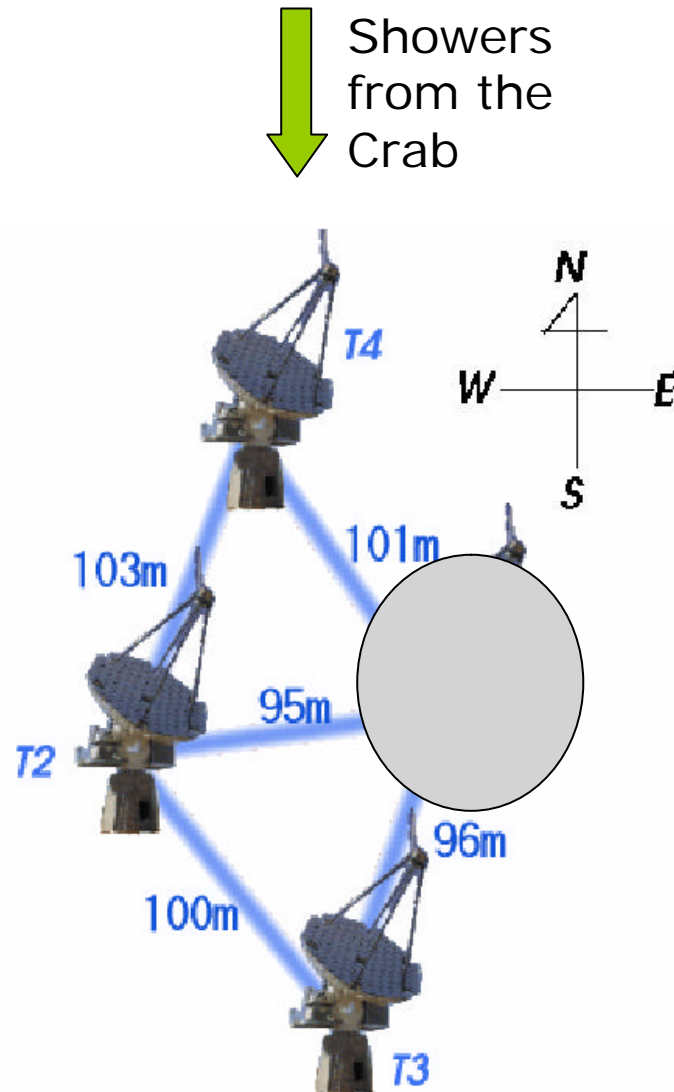

- ❑ The oldest T1 has higher energy threshold and bad efficiency for stereo observation
- ❑ Only T2/T3/T4 are used for stereo analysis
- ❑ Stereo baseline becomes short for the Crab observation at large zenith angles

# Large zenith angle observation of the Crab

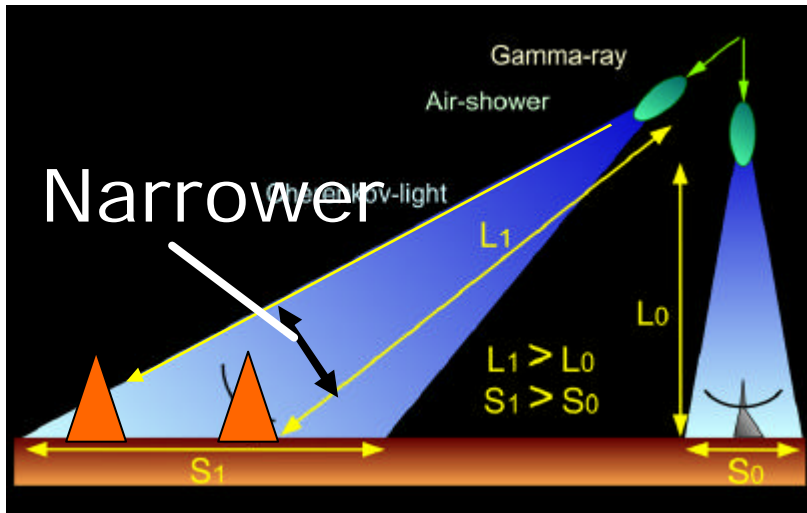

Higher energy threshold  $\sim 1\text{TeV}$   
Bad intersection accuracy

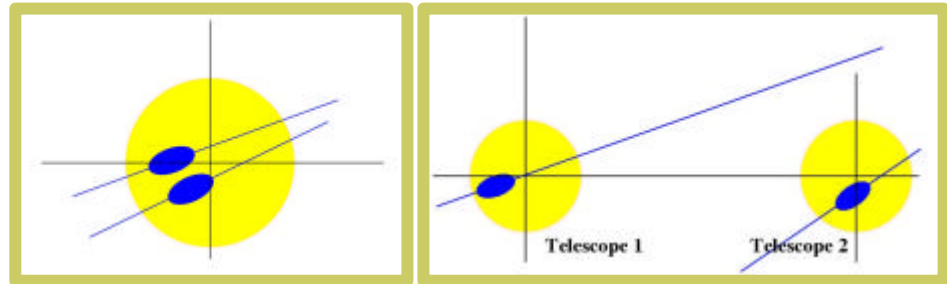

Far core  $\rightarrow$  small angle  $\rightarrow$  bad accuracy

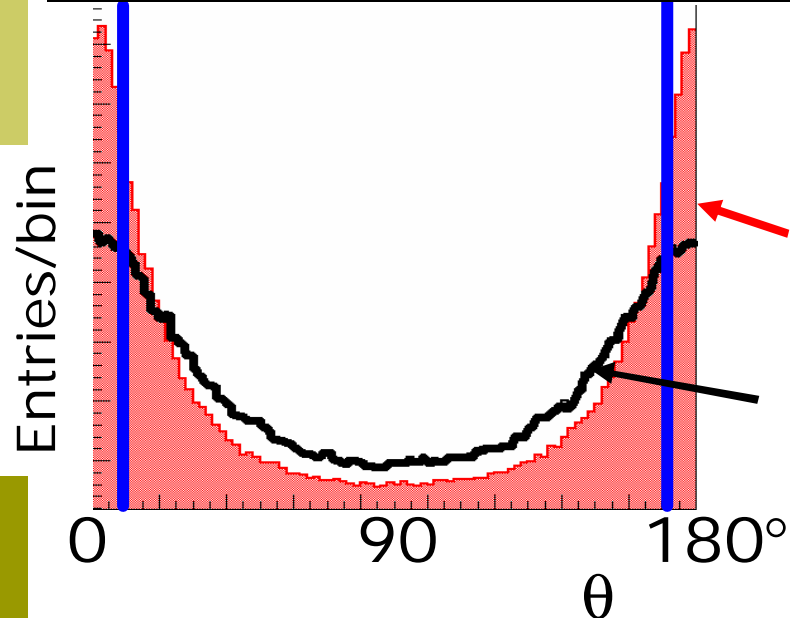

$h \sim 30^\circ$

$h \sim 60^\circ$

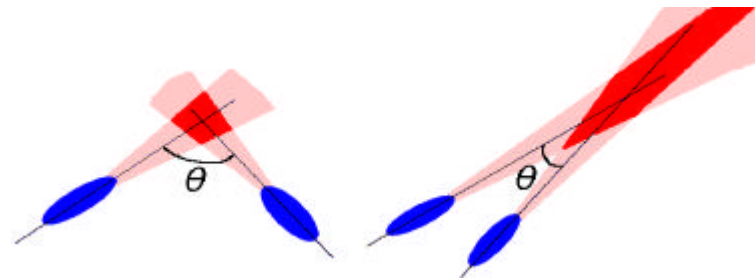

Accept  $15^\circ < \theta < 165^\circ$  only

# Crab signal (1)

Team "A"

(simple square cuts)

Nov 2003

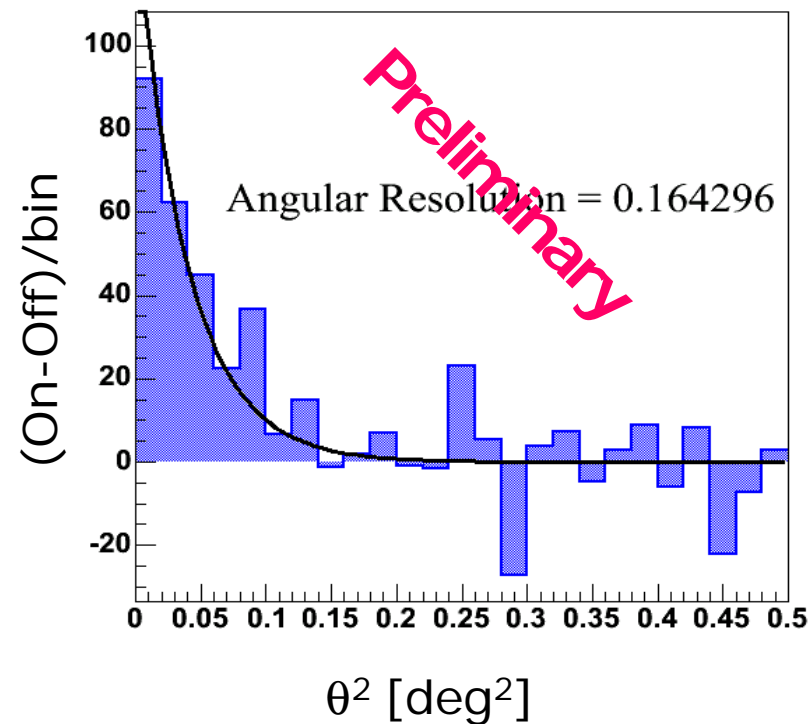
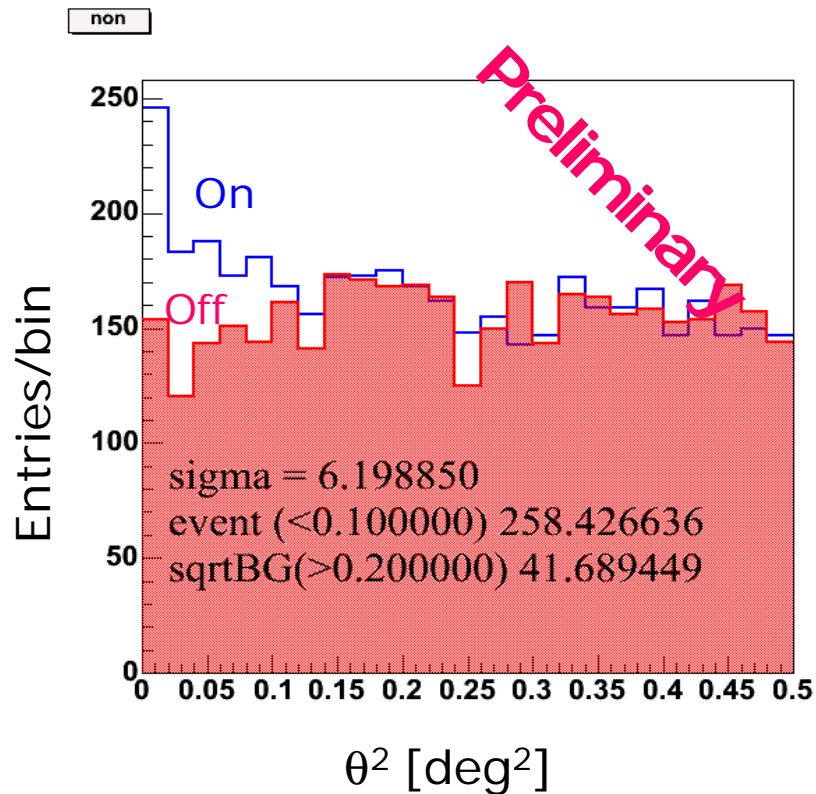

Sigma : 6.19

Excess : 258±42 event

Angular Resolution : 0.16° (HWHM)

•T2 & T3

•ON 7.5hr

•OFF 7.0hr

# Crab signal (2)

Team "A"

- Significance map

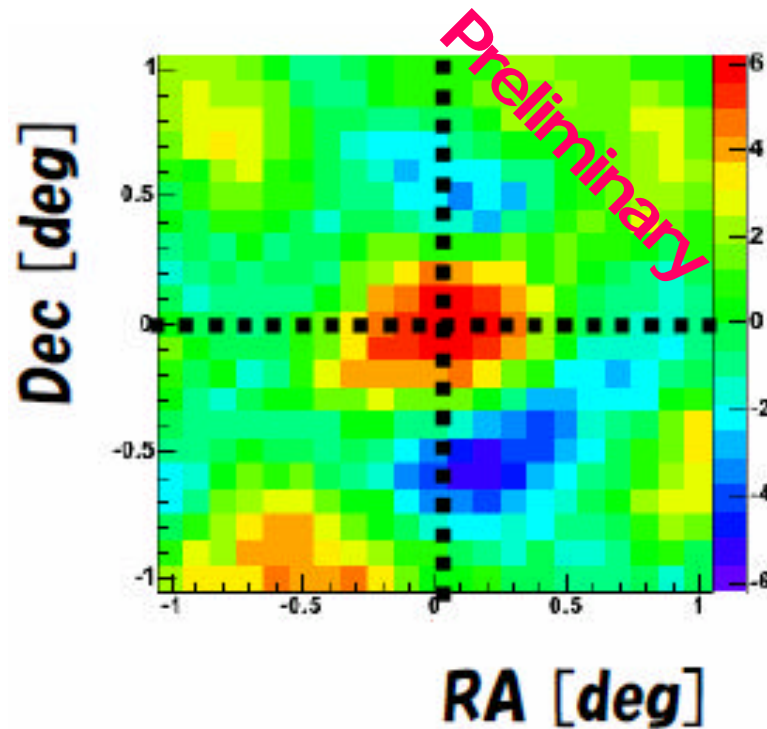

Angular resolution for the Crab ( $h \sim 35^\circ$ )  
 $\sim 0.17^\circ$  (RA) /  $0.14^\circ$  (Decl)

- Differential flux

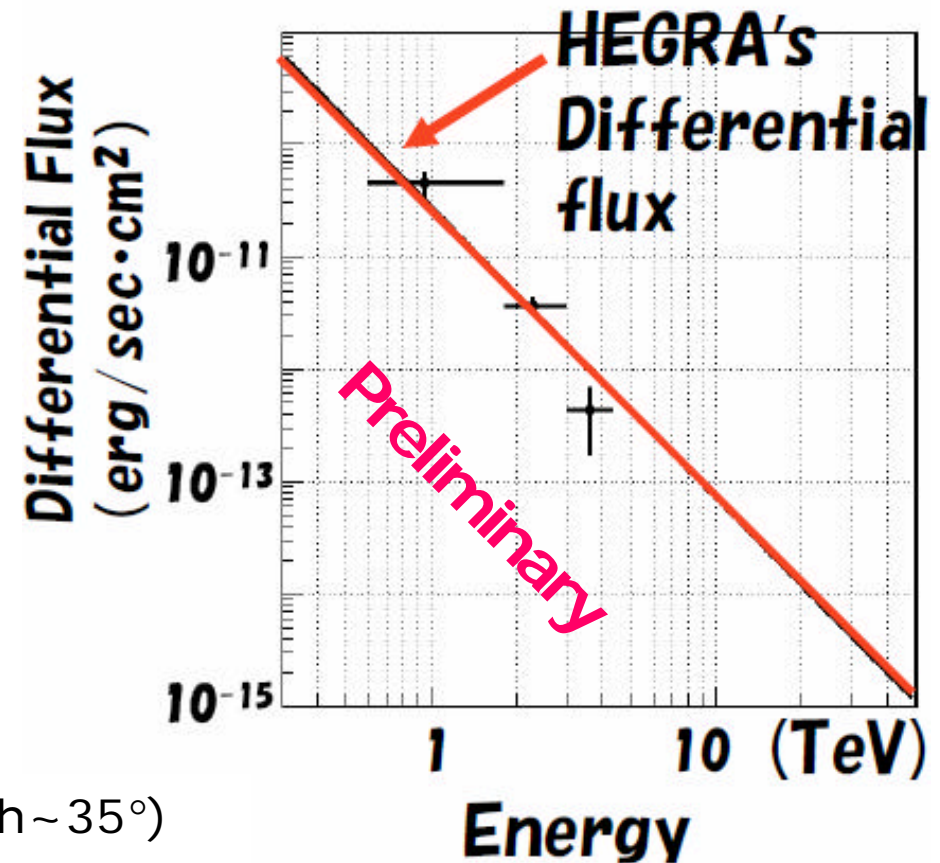

# IP constraint fit

$$c^2 \equiv \sum_{\text{Telescopes}} \left[ \left( \frac{\text{Width}(x,y)}{\mathbf{s}_w} \right)^2 + \left( \frac{\text{Armlength}(x,y) - \langle \text{Armlength} \rangle}{\mathbf{s}_{ARM}} \right)^2 \right]$$

Search intersection point (IP) by minimizing  $\chi^2$  so that width along shower axis to be minimum and armlength to be near the expected value ( $\langle \text{Armlength} \rangle = 0.75$ , Mesh size  $0.025^\circ$ )

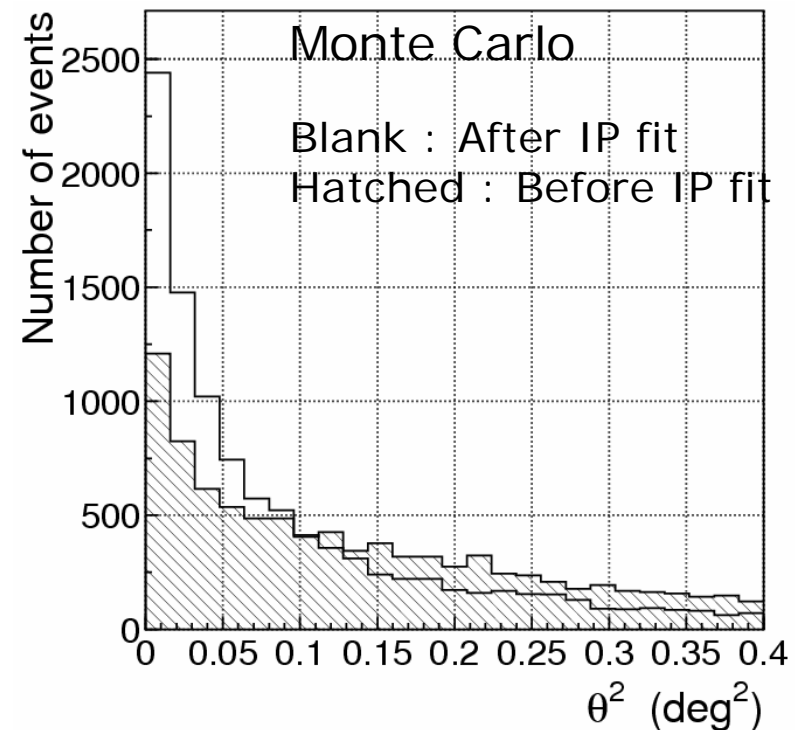
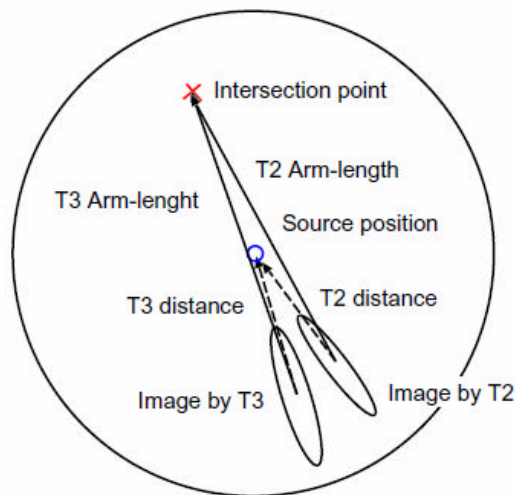

# $\gamma/h$ separation by Fisher discriminant

- Linear combination of image parameters ( $x_i$ )

$$F \equiv \sum_i \mathbf{a}_i x_i$$

- Difference between signal ( $\gamma$ ) and background ( $h$ )

$$D \equiv \langle F_g \rangle - \langle F_h \rangle$$

- Determine  $\alpha_i$  which maximize separation (solvable using correlation matrix)

$$S \equiv \langle D \rangle^2 / \langle (D - \langle D \rangle)^2 \rangle$$

- With calculated  $\alpha_i$  for a known source, the (appropriately normalized) combination  $F$  could be the “Fisher discriminant” for other sources.

- We use *widths* and *lengths* of multiple telescopes for image parameters.

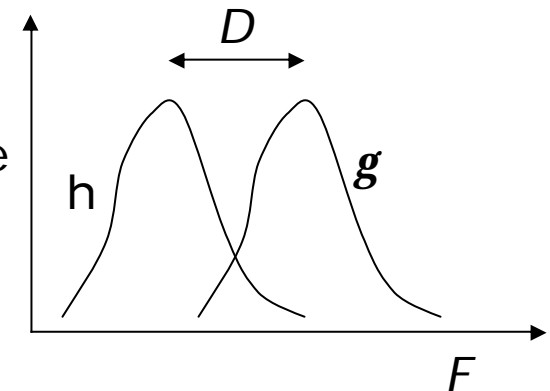

# Crab signal (3)

Team "B"

(with IP fit & Fisher D.)

Points: On-source  
Hatched: Off-source

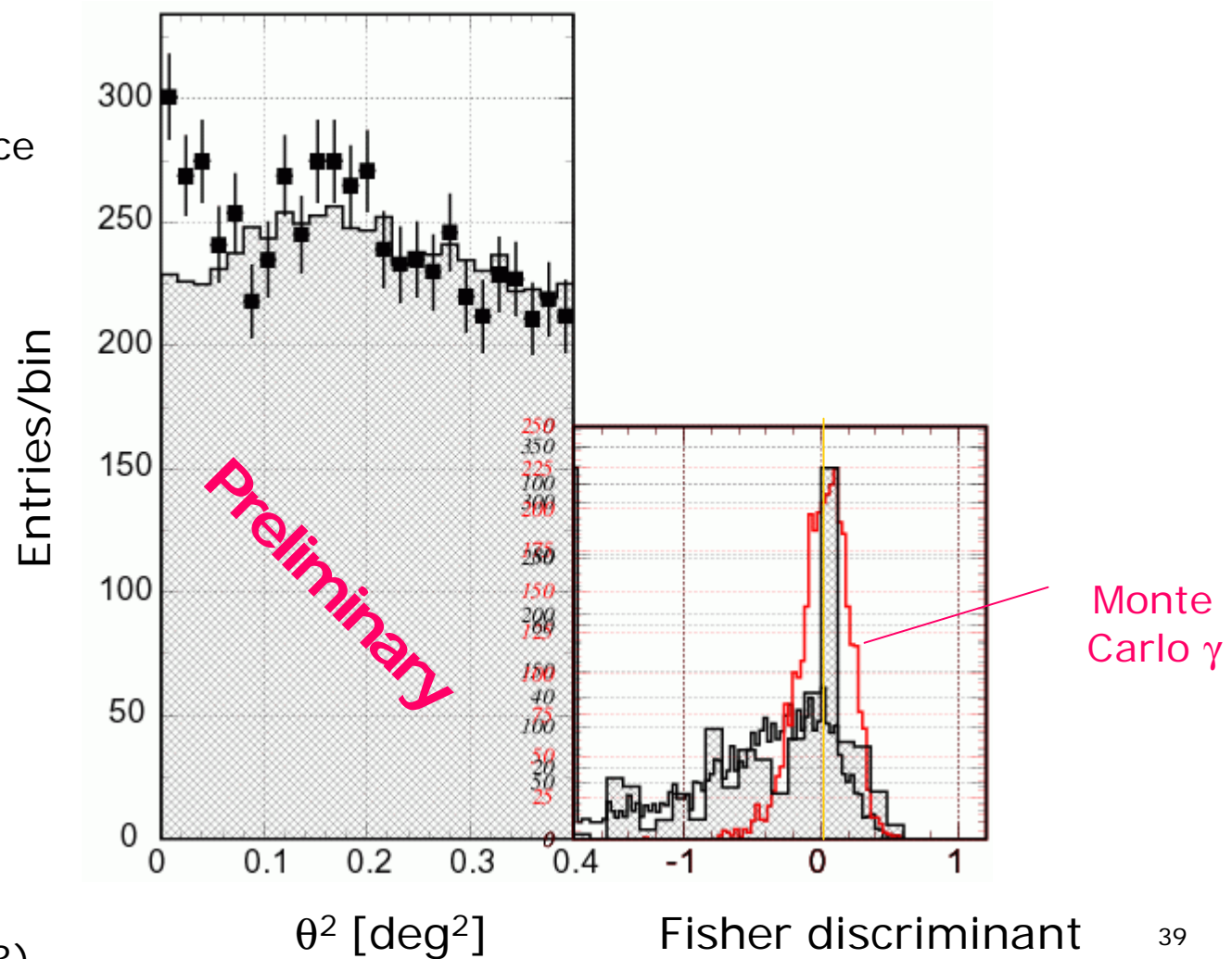

- T2 & T3
- 890 min (Dec.2003)

# Crab spectrum

Team "B"

(with IP fit & Fisher D.)

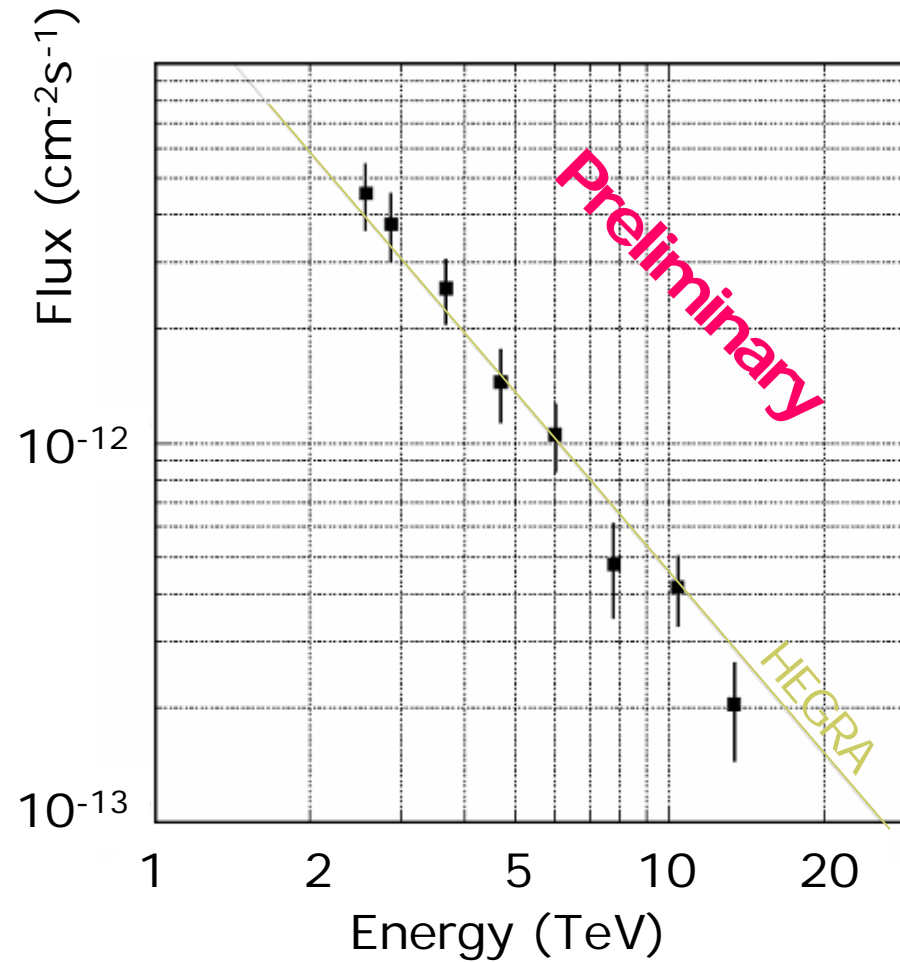

- T2 & T3

- 890 min (Dec.2003)



# Cen A: the nearest AGN

S. Kabuki



Near infrared image  
2MASS  
1.2-2.17 $\mu$ m

- Elliptical
- Radio galaxy
- Fanaroff-Riley type I
- "Misaligned" BL Lac ( $\sim 60^\circ$ )
- Distance 3.5 Mpc ( $z=0.00183$ )

Observation term	Observation time (T2-T3)	Observation time (T2-T4)	Average zenith angle
15 – 28 Mar 2004	603 min	414 min	17 degree
15 – 28 Apr 2004	444 min	468 min	17 degree
Total	1047 min	882 min	

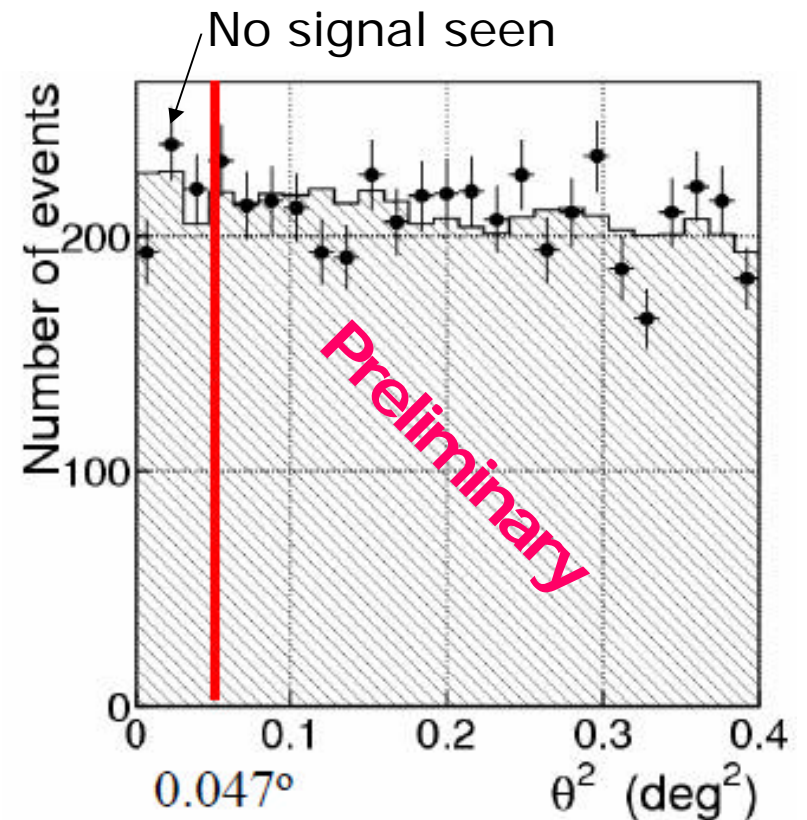

# Cen A: flux limit

S. Kabuki

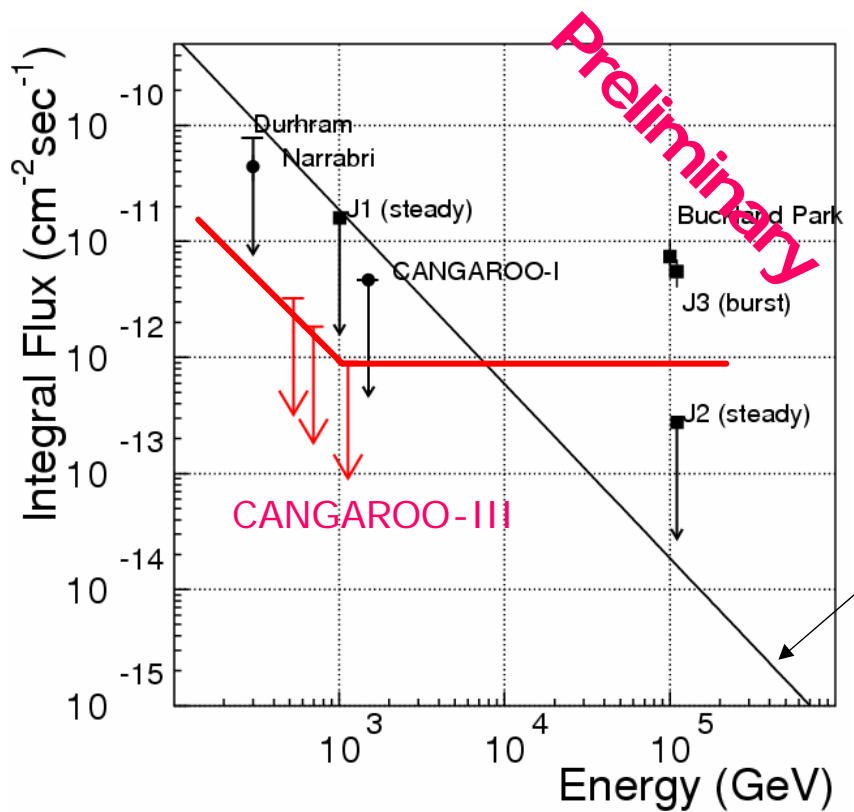

Crab  
Upper limit:  
~7% Crab

Note that this is a highly variable source, and the TeV claim in 70's was based on observations during its <sub>42</sub> flaring activity.

Energy bin (GeV)	530	700	1120
2 $\sigma$ upper limit flux ( $\times 10^{-12} \text{cm}^{-2} \text{sec}^{-1}$ )	3.2	1.8	0.9

# Cen A activity in the past

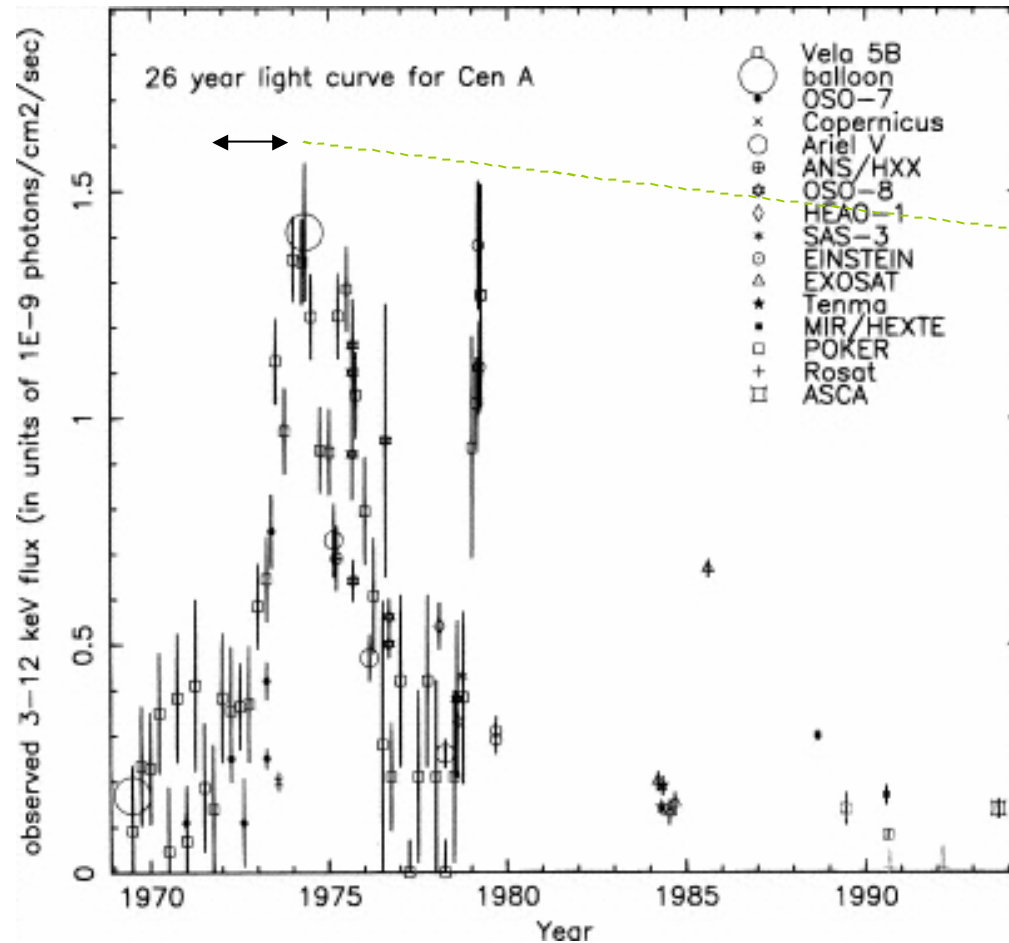

Grindlay  
et al. ApJ  
197  
(1975)  
L9

Turner et al., ApJ 475 (1997) 118

# Galactic diffuse emission

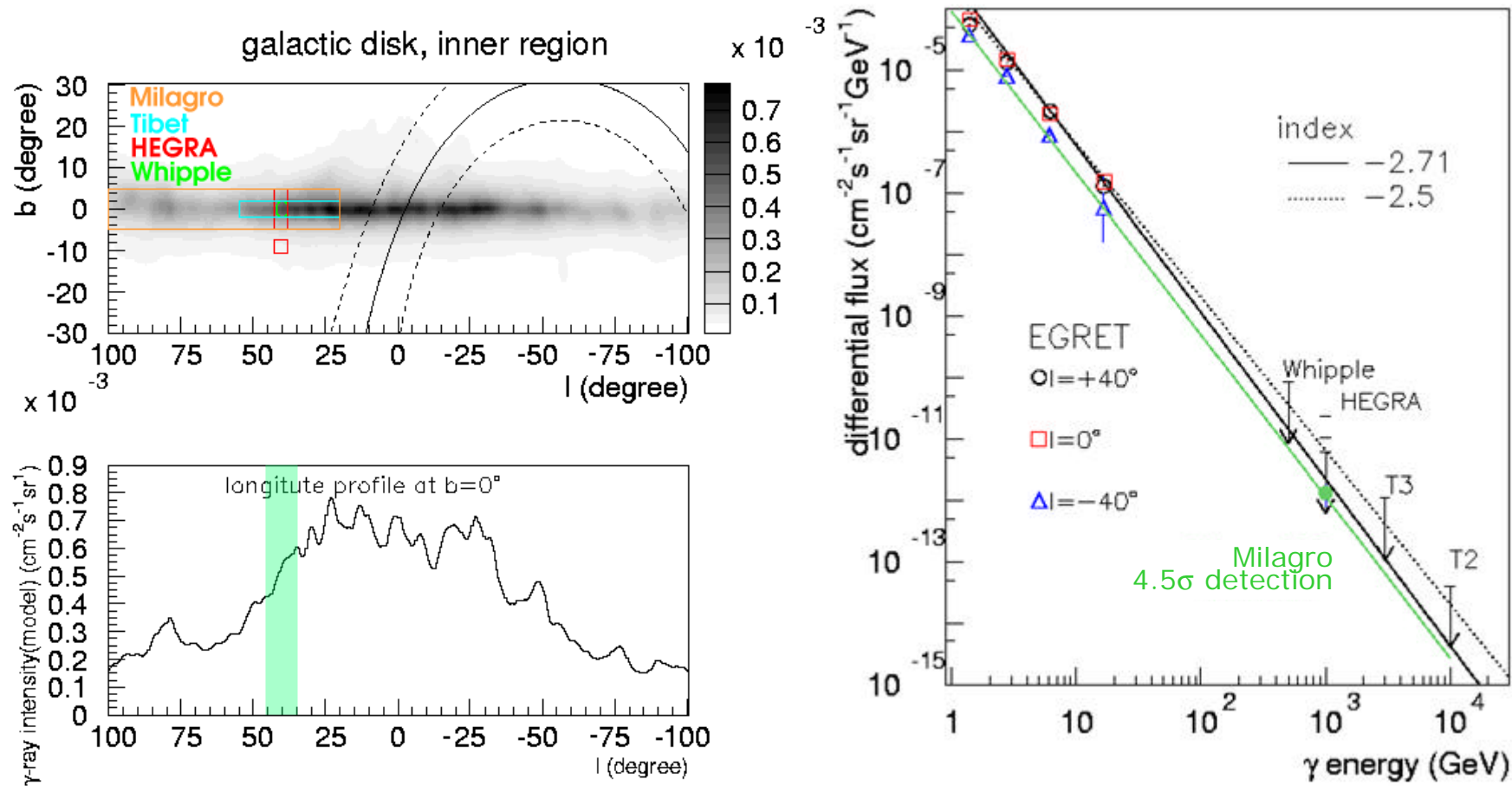

# Observation of the Galactic disk

M. Ohishi

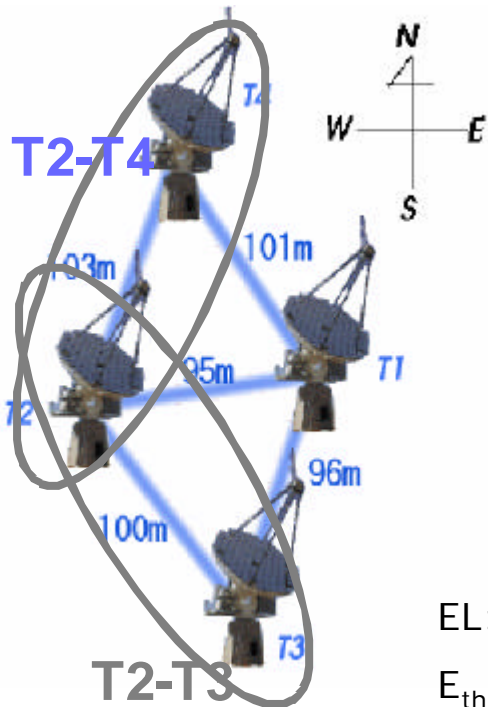
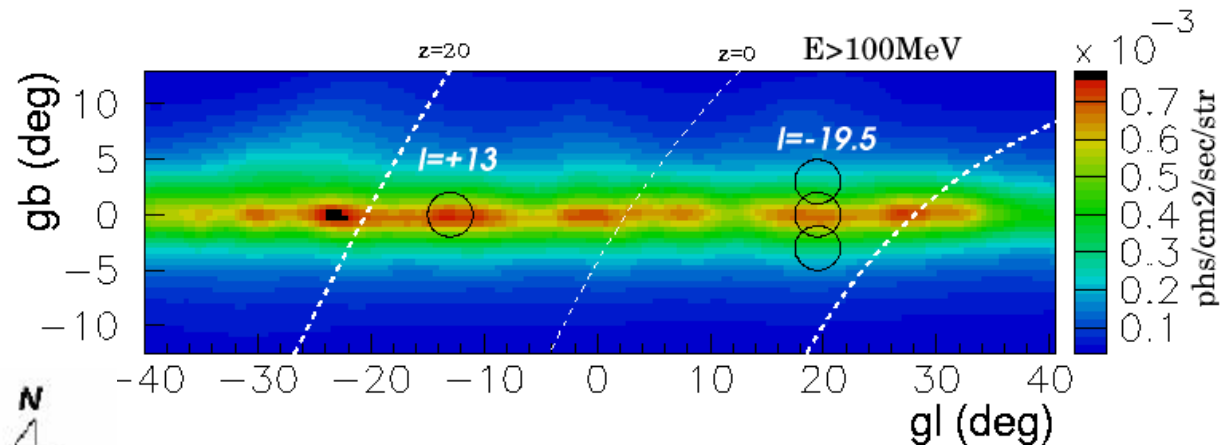

EL > 45deg  
 $E_{th} \sim 600$  GeV

**$l = -19.5$**  2004Jun (Obs.time in minutes)

Obs.term	tel.pair	$b=0^\circ$	$b=-3^\circ$	$b=+3^\circ$
2004Jun	T2-T3	635.3	322.3	292.9
2004Jun	T2-T4	380.0	201.9	192.5

**$l = +13$**  2004Jun/Aug

Obs.term	tel.pair	ON	OFF
2004Jun	T2-T3	289.6	340.0
2004Jun	T2-T4	199.5	270.0
2004Aug	T2-T3	224.9	183.6
2004Aug	T2-T4	280.0	85.7

# Galactic disk scan result

M. Ohishi

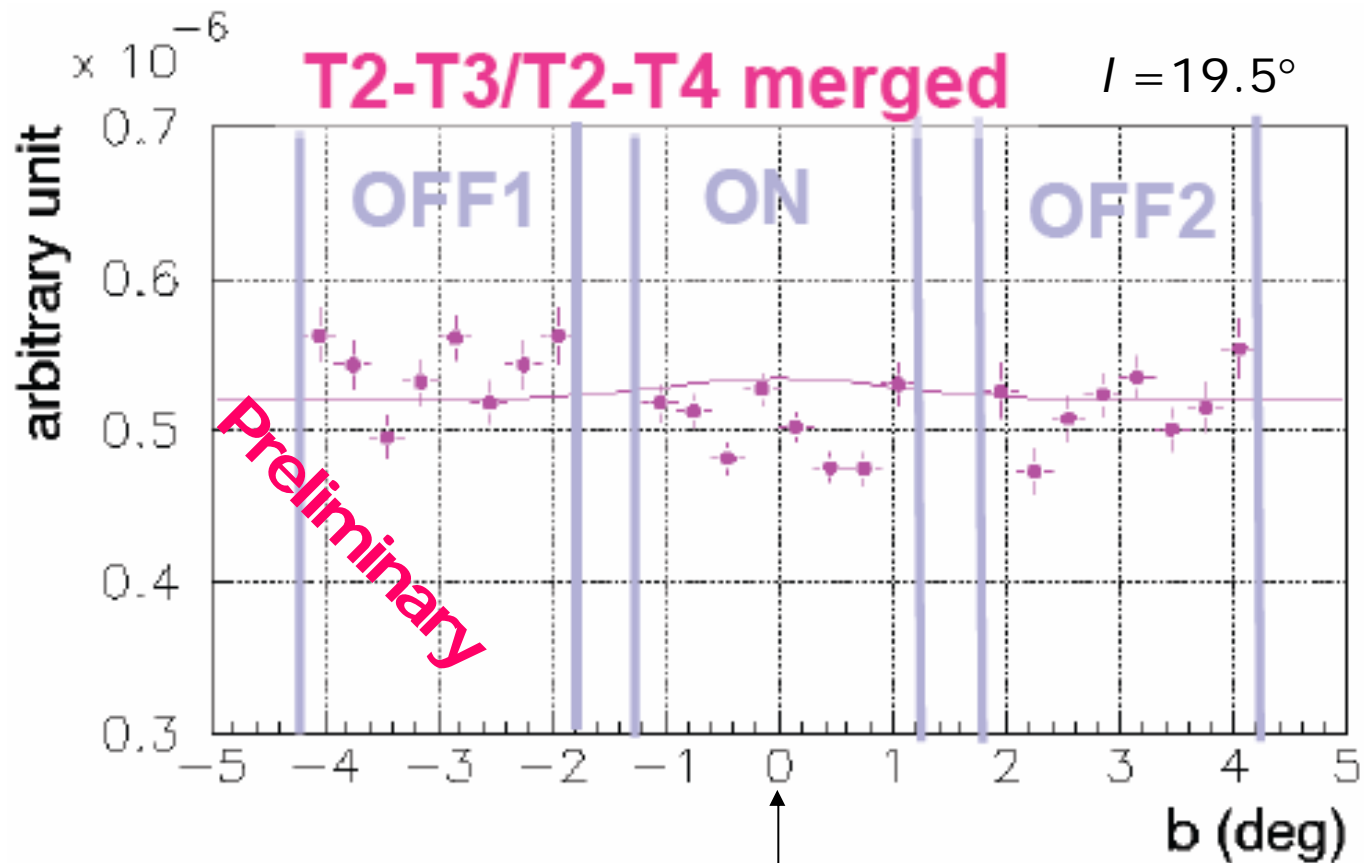

No excess at the disk!  
(expected  $\sigma \sim 1$ deg)

# Galactic diffuse emission: upper limit

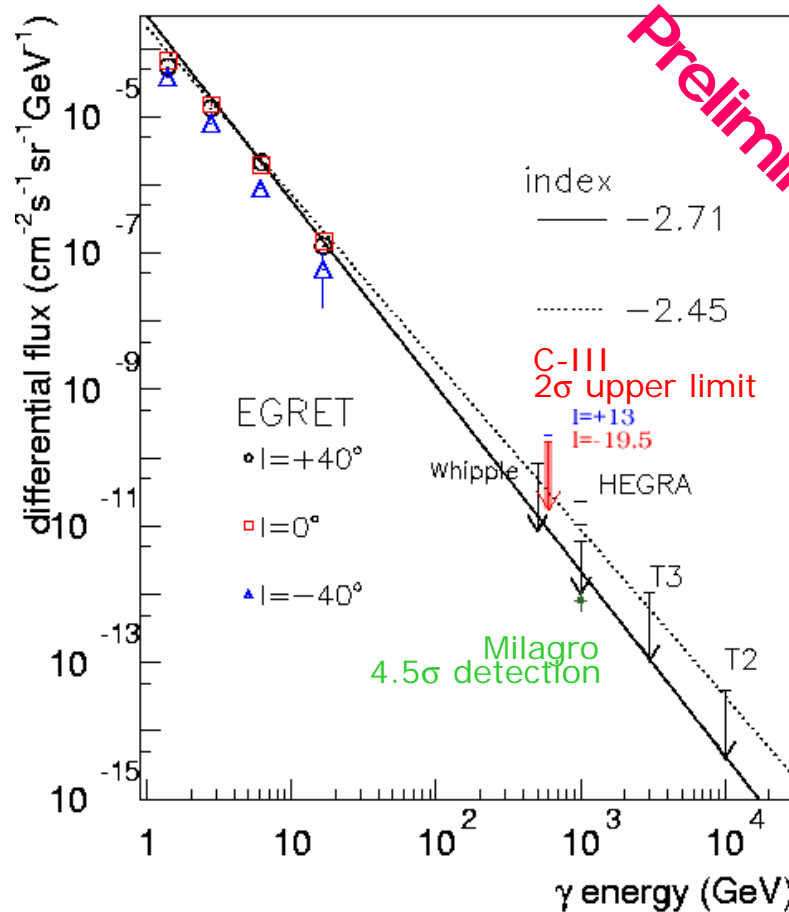

Preliminary

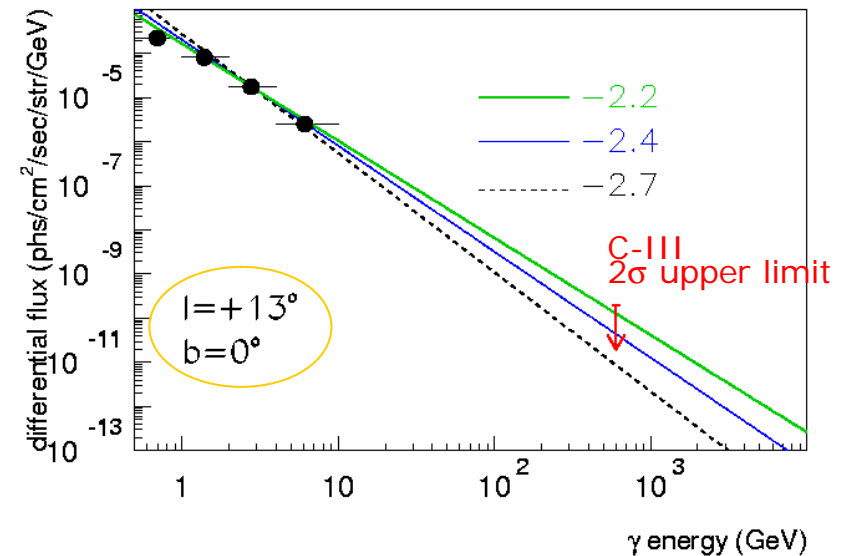
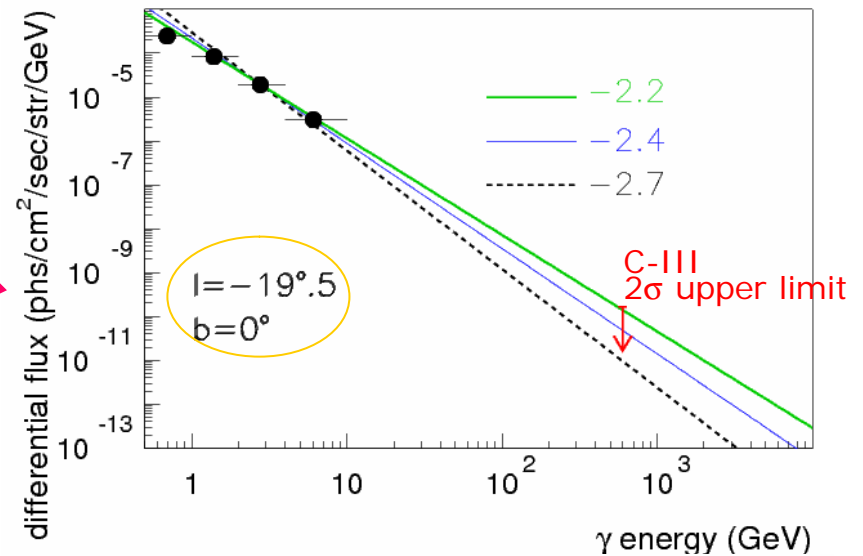

CANGAROO-III: syst.error included

Other TeV obs: Cygnus regions

# Galactic diffuse emission: “GeV bump”

---

- Hard cosmic-ray spectrum?
  - Mori, ApJ 478 (1997) 225
  
- Inverse Compton?
  - Pohl & Esposito, ApJ 507 (1998) 327
  
- $pp \rightarrow \pi^0 X$  cross section?
  - Diffractive interaction & scaling violation
  - Kamae, Abe & Koi, ApJ 620 (2005) 244
  
- Dark gas contribution
  - 3EG catalogue may be changed (but not spectra)
  - Grenier et al., Science 307 (2005) 1292



# Diffraction interaction included

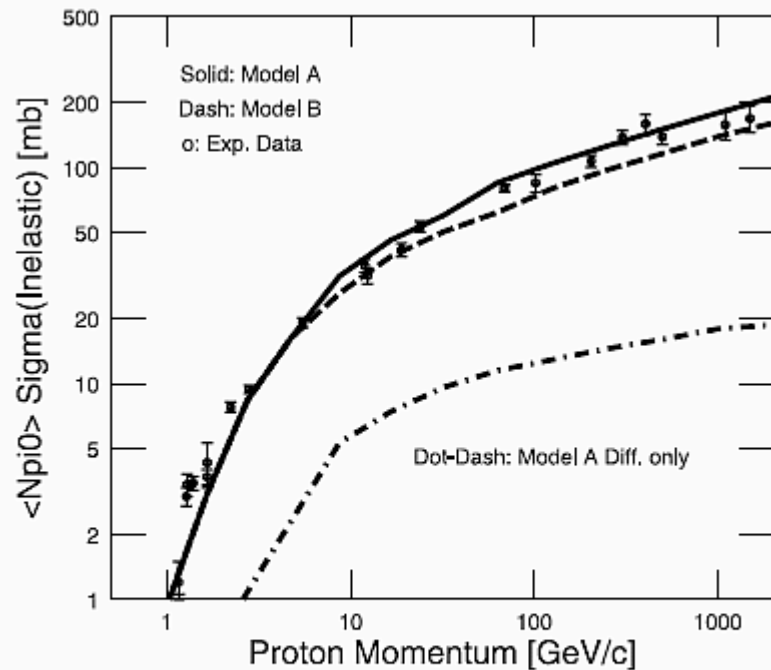

FIG. 5.—Averaged neutral pion multiplicity for the  $p$ - $p$  and  $\bar{p}$ - $p$  inelastic interaction. Curves are for model A All (solid), model B (dashed), and model A diffractive (dot-dashed). Data are from Table 1 of Dermer (1986).

Kamae, Abe & Koi, ApJ 620  
(2005) 244

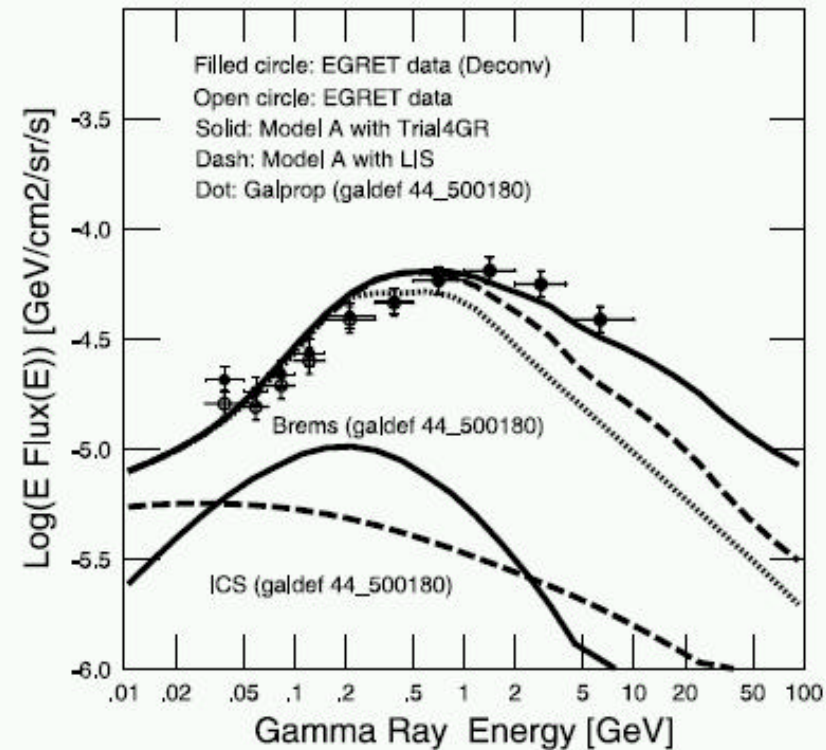
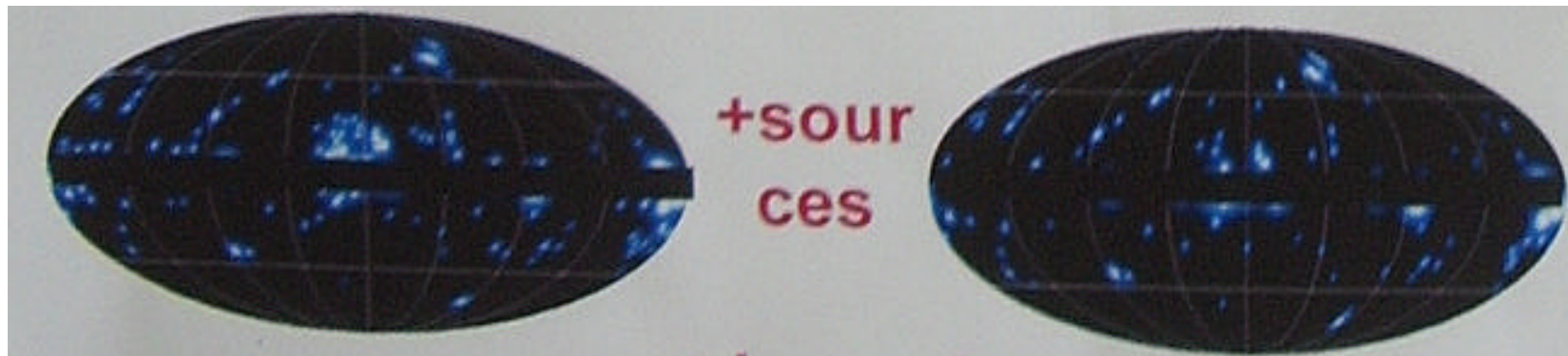
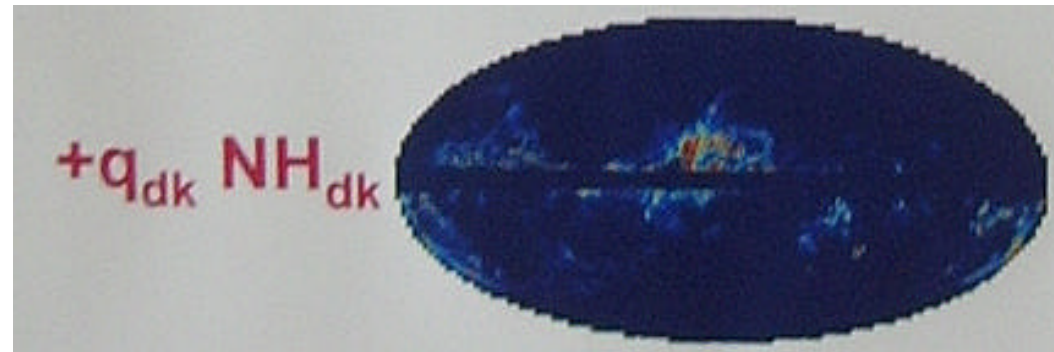

FIG. 8.—Model gamma-ray spectra including the contributions from bremsstrahlung and inverse Compton and the EGRET data; Data labels are same as in Fig. 7. Model curves are for the bremsstrahlung (Brem) and inverse Compton scattering (ICS) contribution, of GALPROP with parameters galdef 44\_500180 in Strong et al. (2004). Other curves are for model A (Trial4GR)+Brem+ICS (solid); model A (LIS)+Brem+ICS (dashed);  $\pi^0$ +Brem+ICS by GALPROP with galdef 44\_500180 (Strong et al. 2004; dotted).

# Dark gas contribution

---



(old)

EGRET catalogue

(new)

Grenier, Cherenkov2005 poster

# SNR RX J0852.0-4622

Team "B"

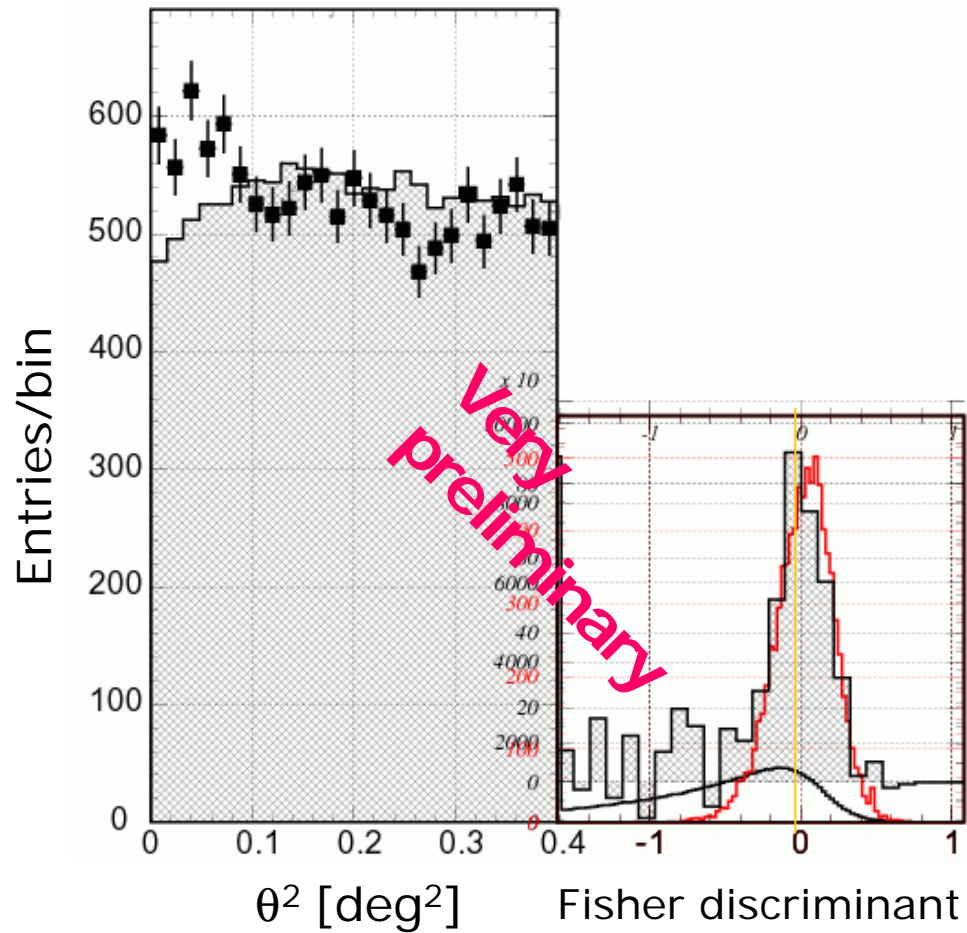

Fisher D. set at the Crab level

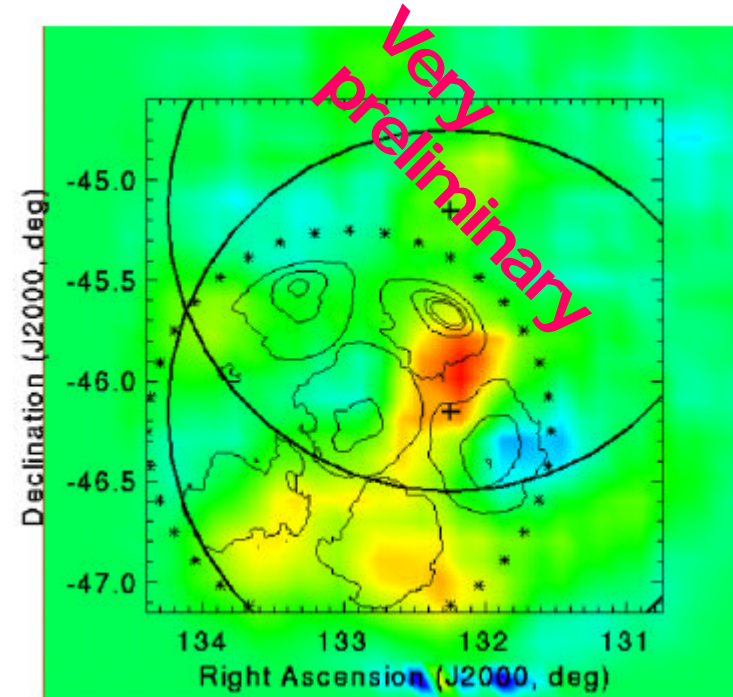

- T2 & T3
- 1204min (Jan.15-Feb.24, 2004)

For single telescope observations, see Katagiri et al., ApJ 619 (2005) L163

# SN1006

Team "A"

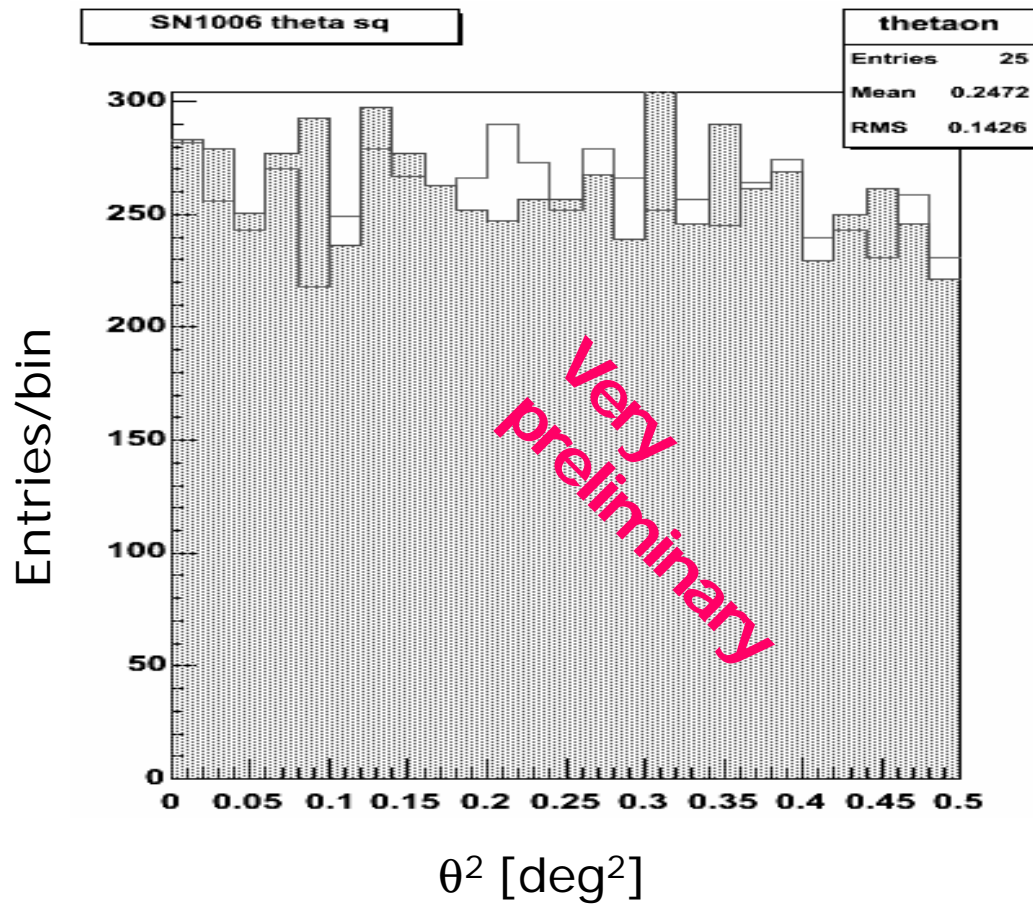

Blank: CANGAROO-I  
hot spot

Hatched: Off-source

- T2 & T3
- ON 1954min
- OFF 1606min  
(May 14-26, 2005)

Square cuts at the Crab level

# Vela pulsar

Team "B"

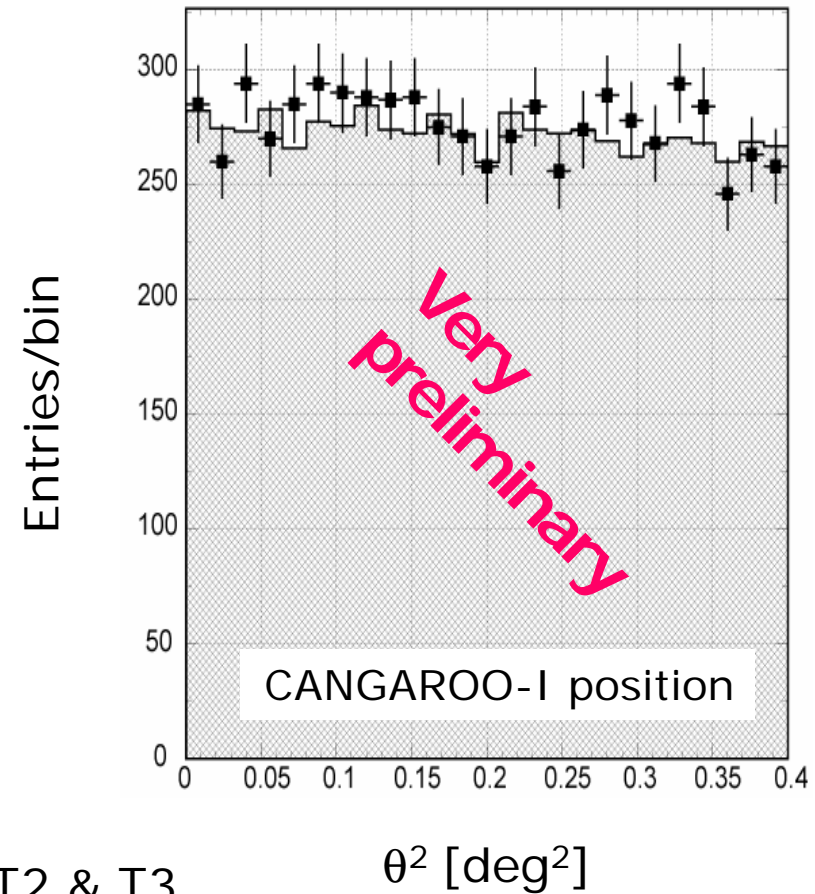
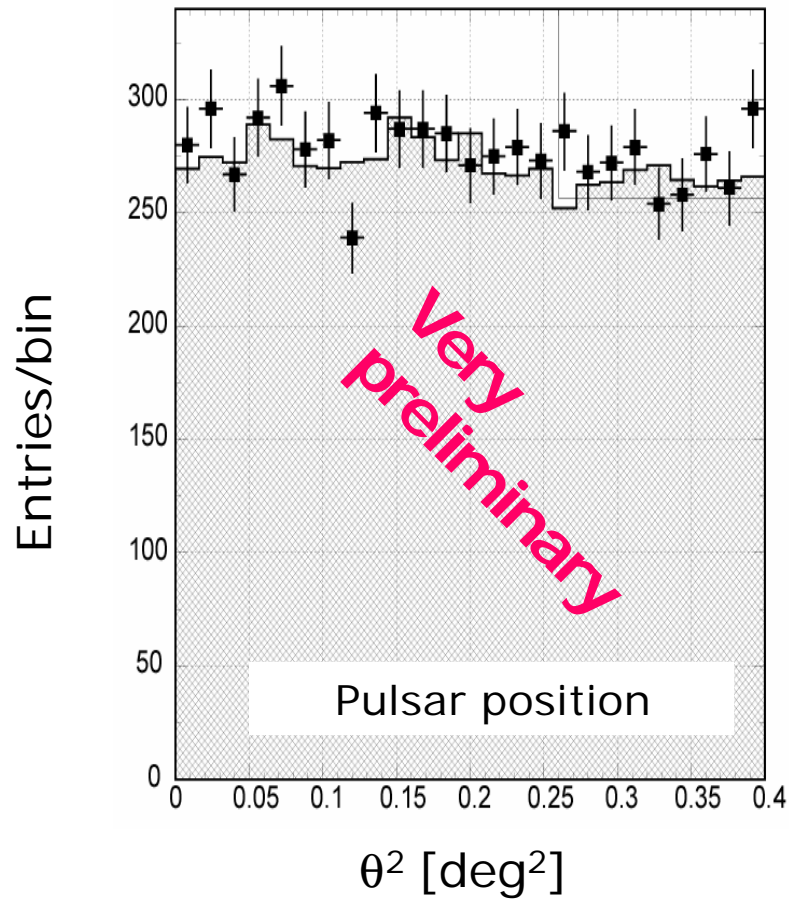

Fisher D. set at the Crab level

- T2 & T3
- 1311 min (Jan.17-Feb.25, 2004)

# Global trigger system

- ❑ Before: “software trigger”
  - Each telescopes triggered independently
- ❑ Now: “hardware stereo”
  - Requires at least 2 telescopes
- ❑ If no coincidence  $\Rightarrow$  Reset
  - Dead time  $\times 1/100$

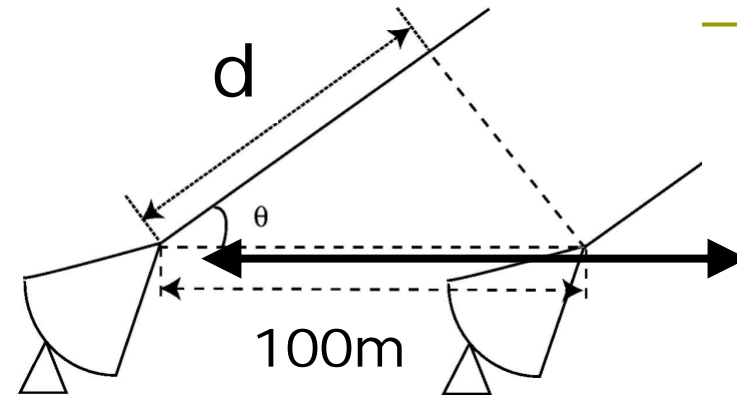

$$\Delta t = d/c < 500\text{ns}$$

variable

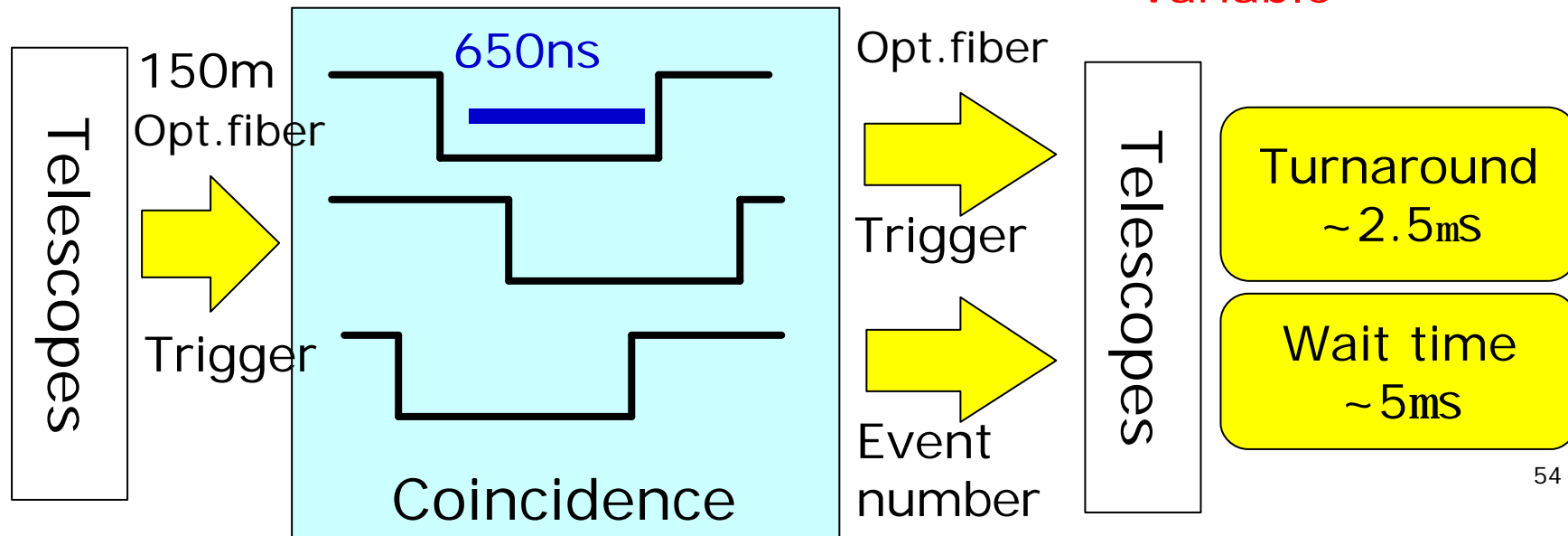

# Effect of global triggers

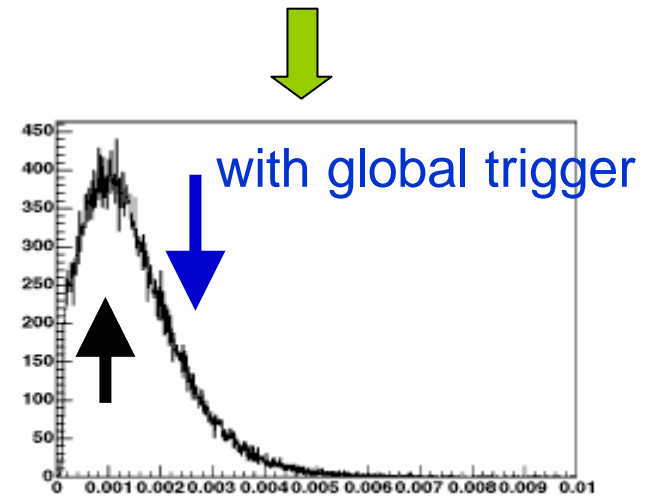
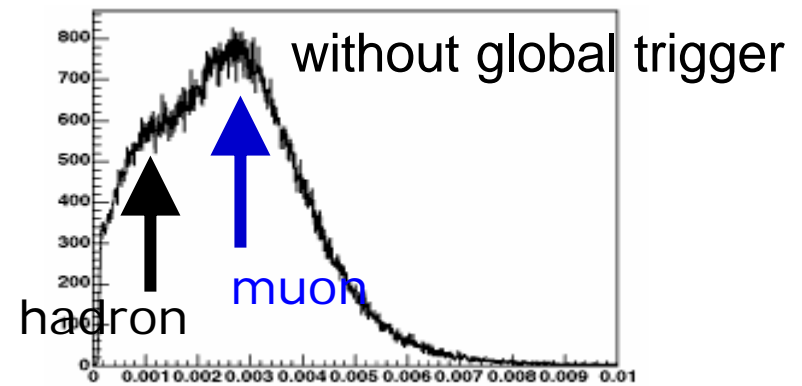
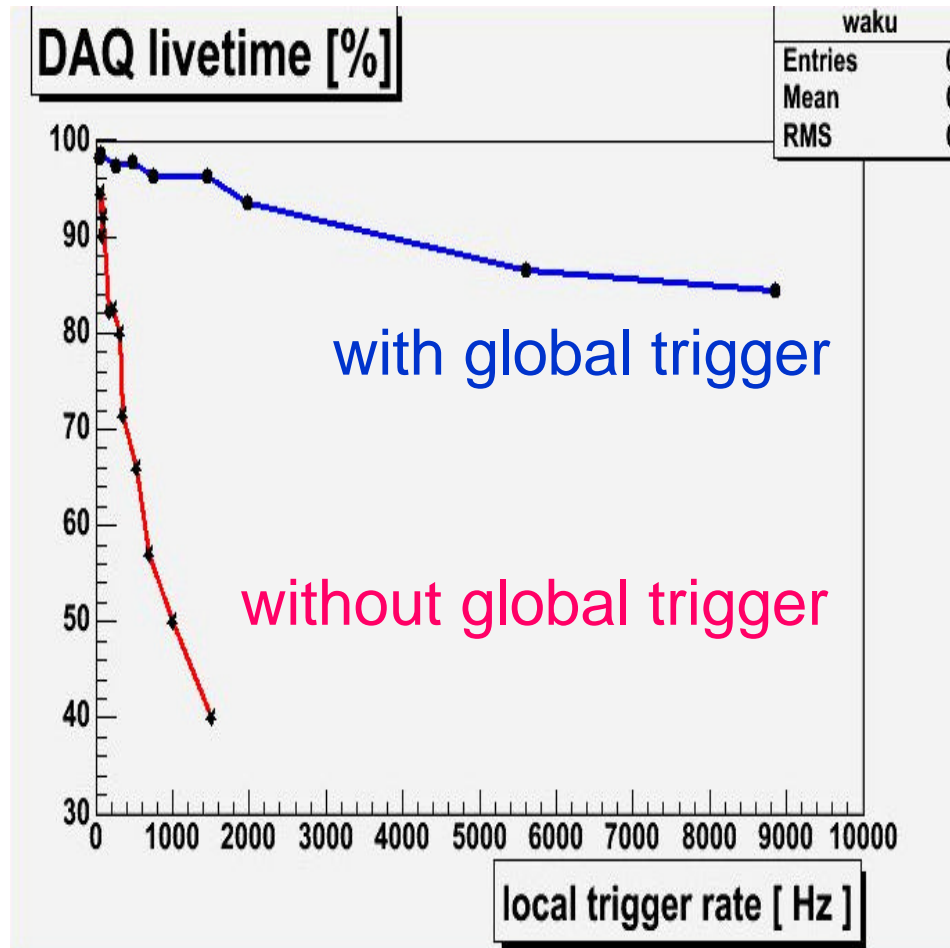

Length/size

Muon events are removed!



# Summary

---

- ❑ We have been carrying out 4-telescope stereo observations of sub-TeV gamma-rays since 2004 March. Now we have incorporated a global trigger system to reduce muons.
- ❑ Stereo analyses are being developed using muons for calibration, and the energy spectrum of the Crab is consistent with other results.
- ❑ Preliminary results on Cen A and the Galactic disk show no gamma-ray signal. SNR RX J0852.0-4622 appears as extended source, and the morphological study is progressing.
- ❑ Observations of SN1006 and Vela pulsar were made by using CANGAROO III telescopes. Very preliminary analyses appear to show no significant signals, which may suggest upper limits lower than the CANGAROO-I fluxes obtained several years ago.