

Demonstration of Negative Group Delays in a Simple Electronic Circuit

Masao Kitano

`kitano@kuee.kyoto-u.ac.jp`, Room #1213

Kyoto University

Group Delays in Circuits

Group delays in lumped systems ($L = 0$ or $L \ll c/\omega$)

- Mitchell and Chiao: Am. J. Phys. **66**, 14 (1998)
 - Bandpass Amplifier (LC + opamp)
 - Arbitrary Waveform Generator
- Nakanishi, Sugiyama, and MK: quant-ph/0201001 (to appear in Am. J. Phys.)
 - Highpass Amplifier (RC + opamp)
 - Baseband pulse (No carriers)
 - Band limited signal from rectangular pulser + lowpass filter

Negative delay circuit

- The output LED is lit earlier than the input LED.
 - Negative delay
- Time constants could be order of seconds.
 - We can see it!

Experiment

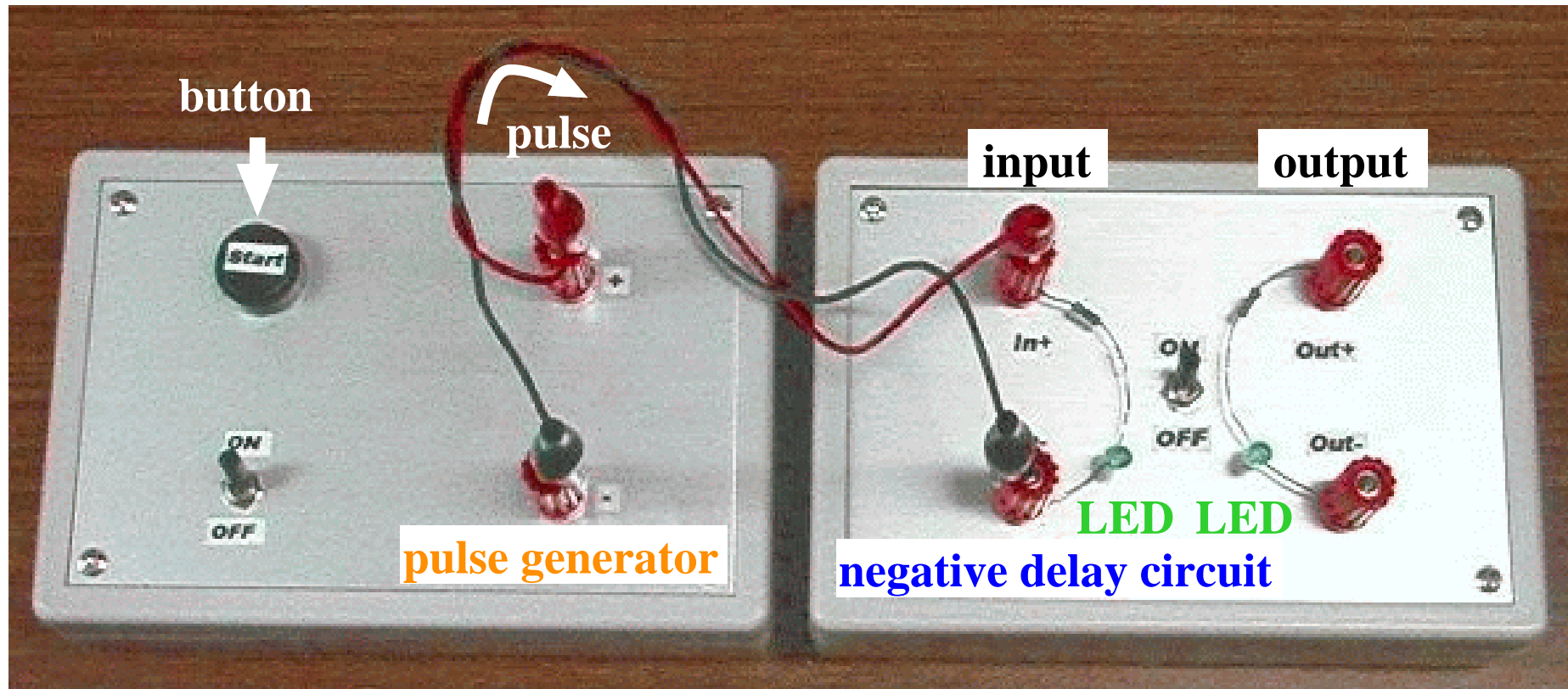

1. rectangular pulse generator + low-pass filter
2. negative delay circuit

Group delays – ideal case

Group delay for base-band signals (delay time: t_d)

$$V_{\text{OUT}}(t) = (h * V_{\text{IN}})(t) = V_{\text{IN}}(t - t_d)$$

$$h(t) = \delta(t - t_d)$$

Fourier Transformed: $\tilde{V}_{\text{OUT}}(\omega) = H(\omega)\tilde{V}_{\text{IN}}(\omega)$

$$H(\omega) = (\mathcal{F}h)(\omega) = \int dt h(t)e^{-i\omega t} = \exp(-i\omega t_d)$$

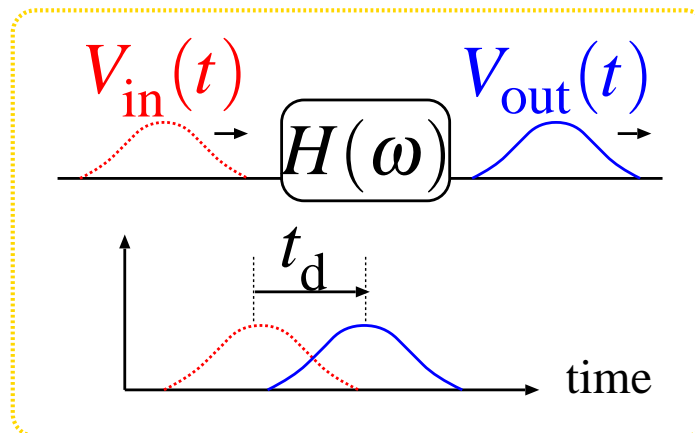

Positive and Negative delays

t_d	Causality	Physical realization
> 0	causal	distributed system
$= 0$	(locally, mutually) causal	lumped system
< 0	non causal	impossible

- Positive delays are easy, if you have an appropriate space.
“Record and play” is also possible.
- No way to make ideal (unconditional) negative delays.
- No lumped systems ($L = 0$) can produce ideal positive or negative delays.

Approximate delay with lumped systems

- Ideal response function $H(\omega)$

$$A(\omega) = |H(\omega)| = 1,$$

$$\phi(\omega) = \arg H(\omega) = -t_d \omega$$

- Approximate realization #1 with lumped systems

$$H(\omega) = \frac{1 + i\omega T}{1 - i\omega T} \quad (1 \text{ pole, } 1 \text{ zero})$$

$$A(\omega) = 1 \quad (\text{flat response})$$

$$\phi(\omega) = 2 \tan^{-1} \omega T \sim 2T \omega$$

Stability condition $\rightarrow T \leq 0$ (only positive delays)

Approximate delay (2)

- Approximate realization #2 with lumped systems

$$H(\omega) = 1 + i\omega T \quad (1 \text{ zero})$$

$$A(\omega) = \sqrt{1 + (\omega T)^2} \sim 1 + \frac{(\omega T)^2}{2} \quad (\rightarrow \text{distortion})$$

$$\phi(\omega) = \tan^{-1} \omega T \sim T\omega$$

No sign restriction on T (positive and **negative** delay)

Asymmetry — positive / negative

Transfer function	positive delay $T < 0$	negative delay $T > 0$
$H(\omega) = 1 + i\omega T$		
$H(\omega) = \frac{1 + i\omega T}{1 - i\omega T}$		

The arrows shows the direction of the phase increase of $H(\omega)$.

Stability condition requires that poles can be only in the upper-half plane, but zero can be anywhere.

Negative Group Delay Circuit

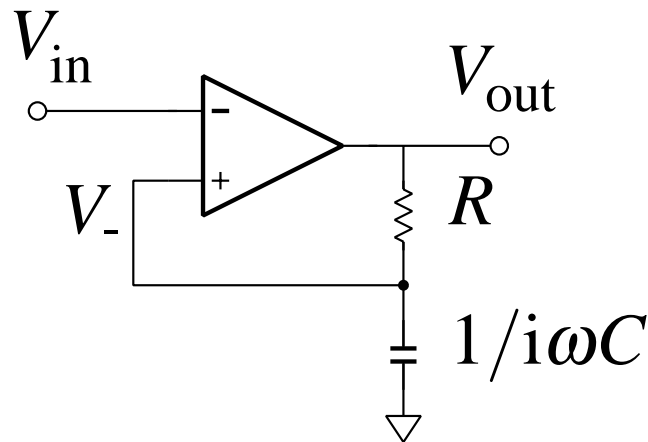

$$V_{-} = \frac{(i\omega C)^{-1}}{R + (i\omega C)^{-1}} V_{\text{out}} = \frac{1}{1 + i\omega CR} V_{\text{out}}$$

$V_{\text{in}} \sim V_{-}$ for large gain of operational amplifier

$$V_{\text{out}} = (1 + i\omega CR) V_{\text{in}}$$

A pole is converted into a zero by the feedback circuit.

Finite bandwidth

- Transfer Function

$$H(\omega) = 1 + i\omega T \quad (T = CR > 0)$$

$$A(\omega) = 1 + O(\omega^2 T^2),$$

$$\phi(\omega) = \omega T + O(\omega^3 T^3)$$

- Spectral condition for input signals

$$|\omega| < \frac{1}{T}$$

Bandwidth

Works only for band-limited signals
— otherwise outputs are distorted.

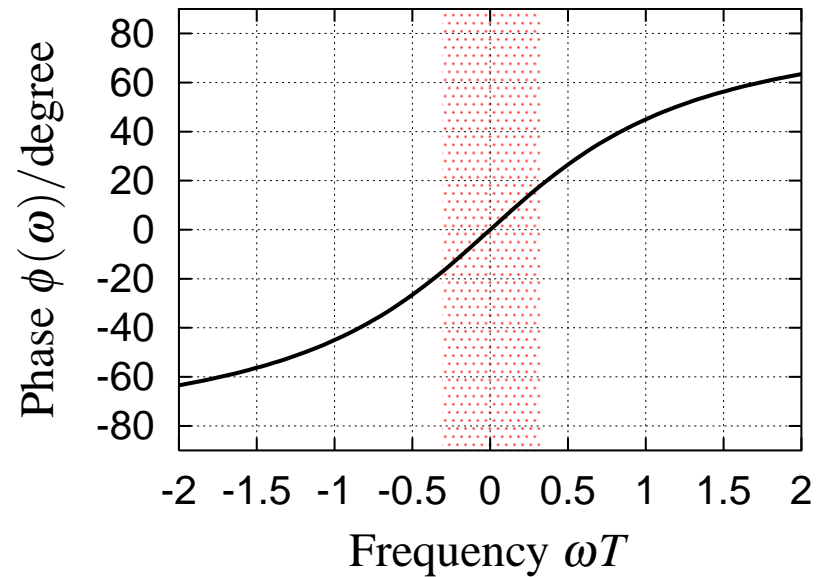
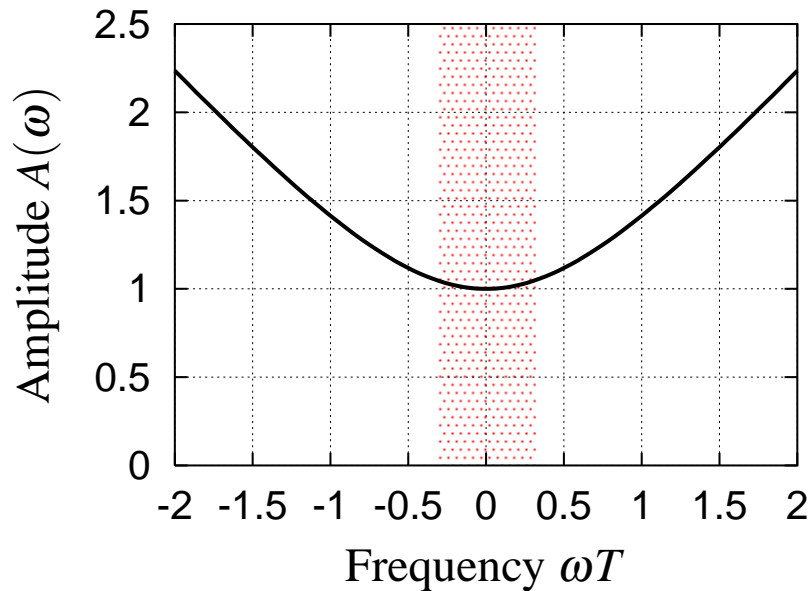

Band-Limit Circuit (Low-pass filter)

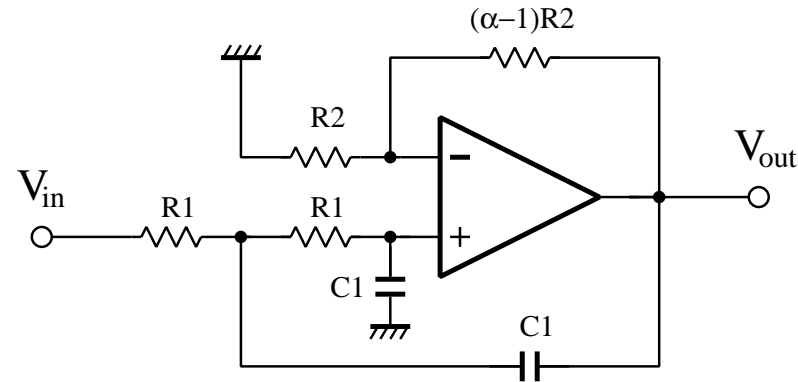

- Bessel filter (2nd order; $m = 2$)

$$H_{LP}(\omega) = \frac{\alpha}{1 + i\omega T_{LP}(3 - \alpha) + (i\omega T_{LP})^2}$$

$$T_{LP} = R_1 C_1, \quad \alpha = (1 + R_3/R_2) = 1.268$$

- Cutoff frequency: $\omega_C = 0.7861/T_{LP}$

Low-pass filters

A rectangular pulser and a series of lowpass filters (m stages) are used to generate band-limited pulses.

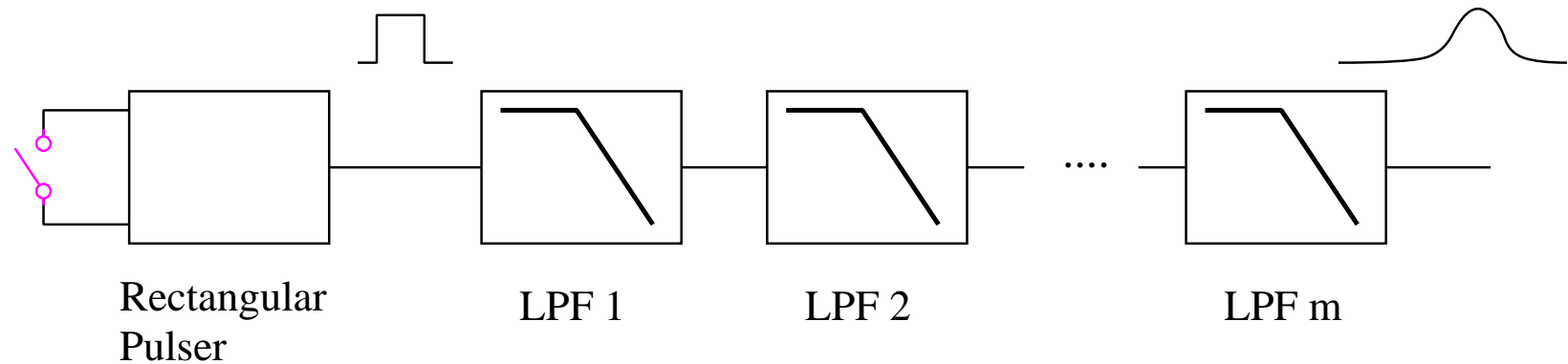

- Pushing the button (at $t = 0$) starts the event.
- The band-limited output has a smooth leading edge.
- A delay comparable to the pulse width is unavoidable.

Low-pass filters(2)

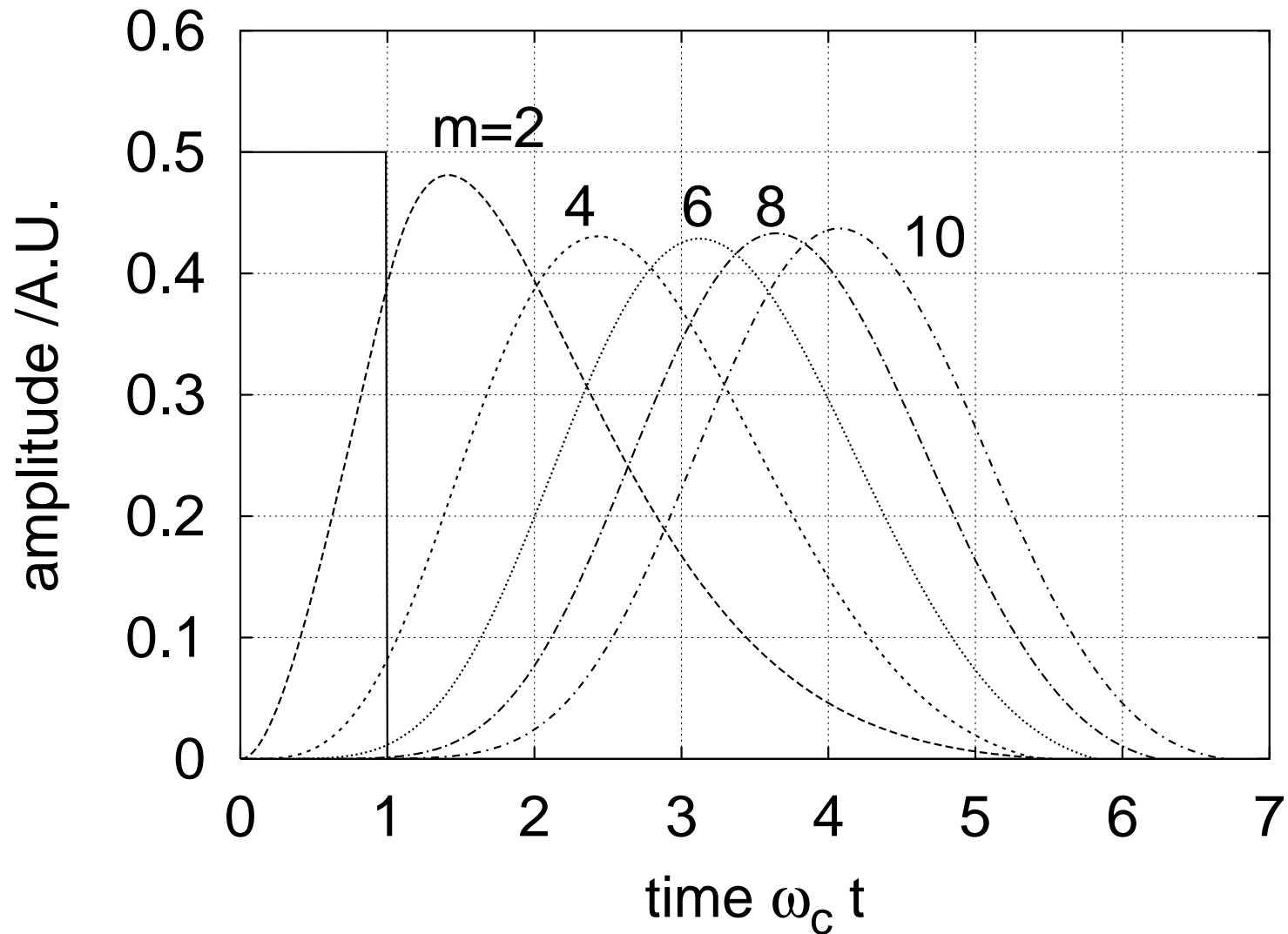

Circuit Diagram

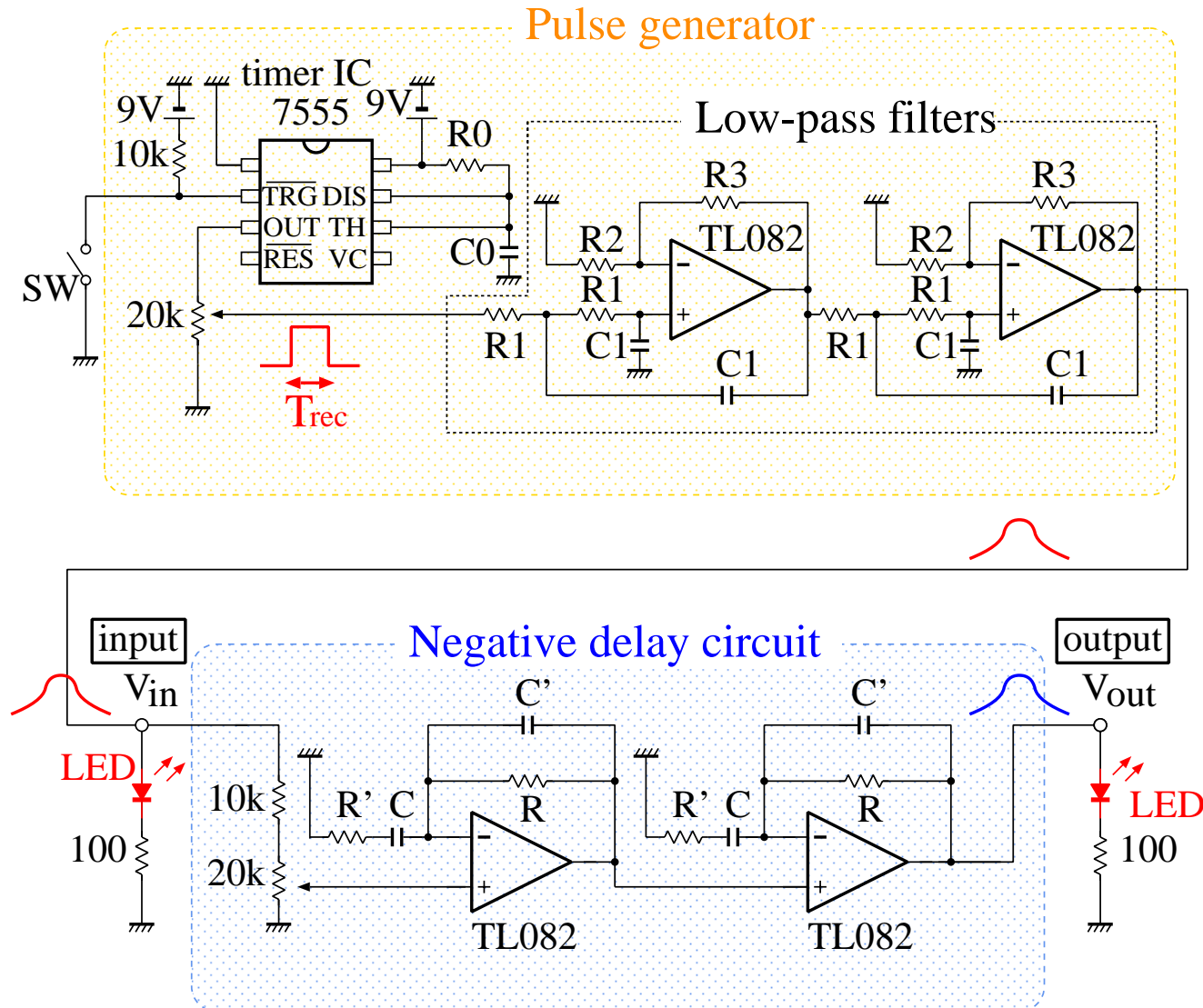

Circuit parameters

Pulse generator

$$R_0 \quad 6.8 \text{ M}\Omega$$

$$C_0 \quad 0.22 \mu\text{F}$$

$$T_{\text{rec}} \quad 1.5 \text{ s}$$

$$R_1 \quad 2.2 \text{ M}\Omega$$

$$C_1 \quad 0.22 \mu\text{F}$$

$$R_2 \quad 10 \text{ k}\Omega$$

$$R_3 \quad 2.2 \text{ k}\Omega$$

$$\omega_c \quad 1.6 \text{ Hz}$$

Negative delay circuit

$$R \quad 1 \text{ M}\Omega$$

$$C \quad 0.22 \mu\text{F}$$

$$R' \quad 10 \text{ k}\Omega$$

$$C' \quad 22 \text{ nF}$$

$$T (= RC) \quad 0.22 \text{ s}$$

Circuit Board

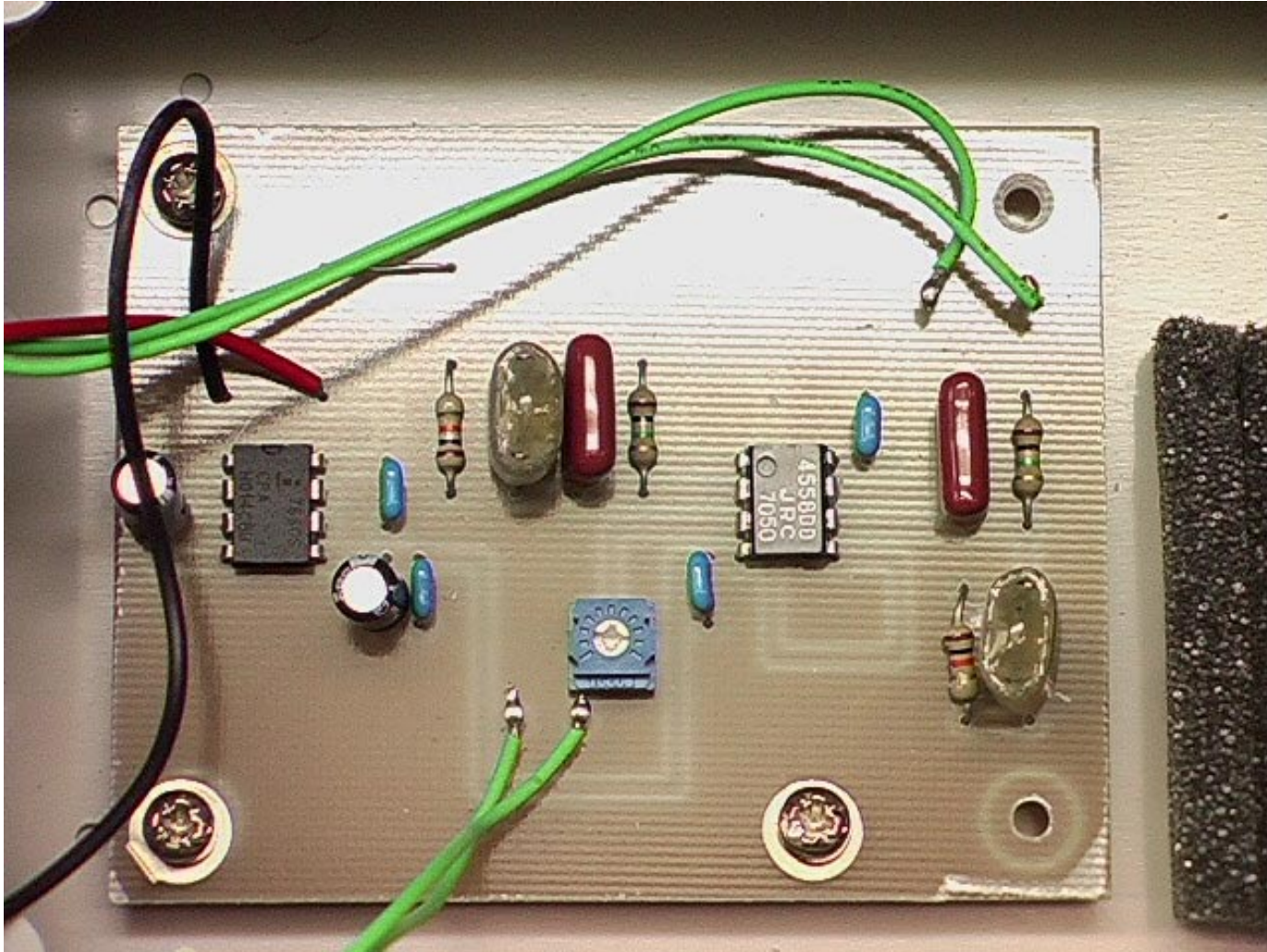

Experimental result

$$m = 4, n = 2$$

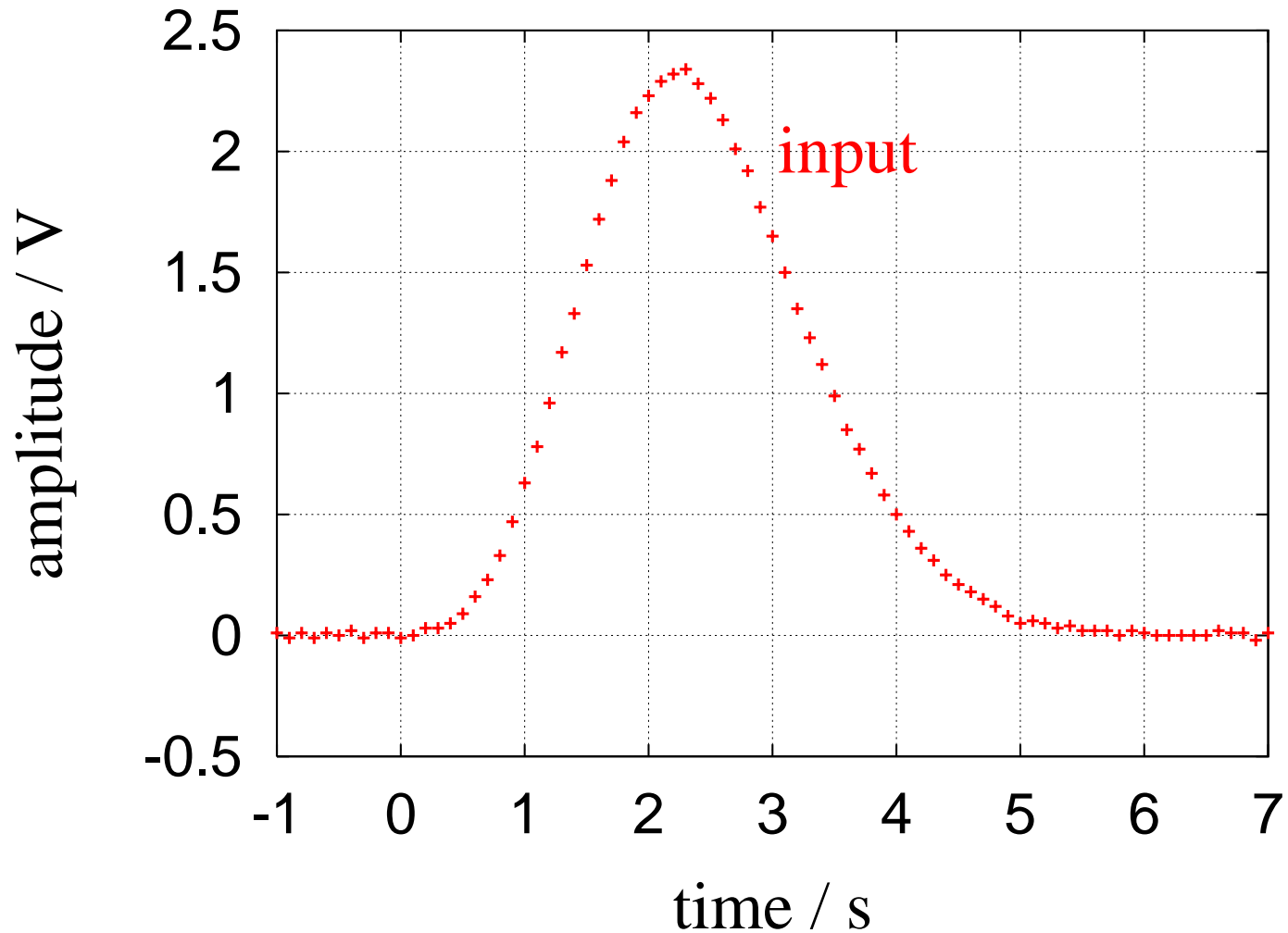

Experimental result

$$m = 4, n = 2$$

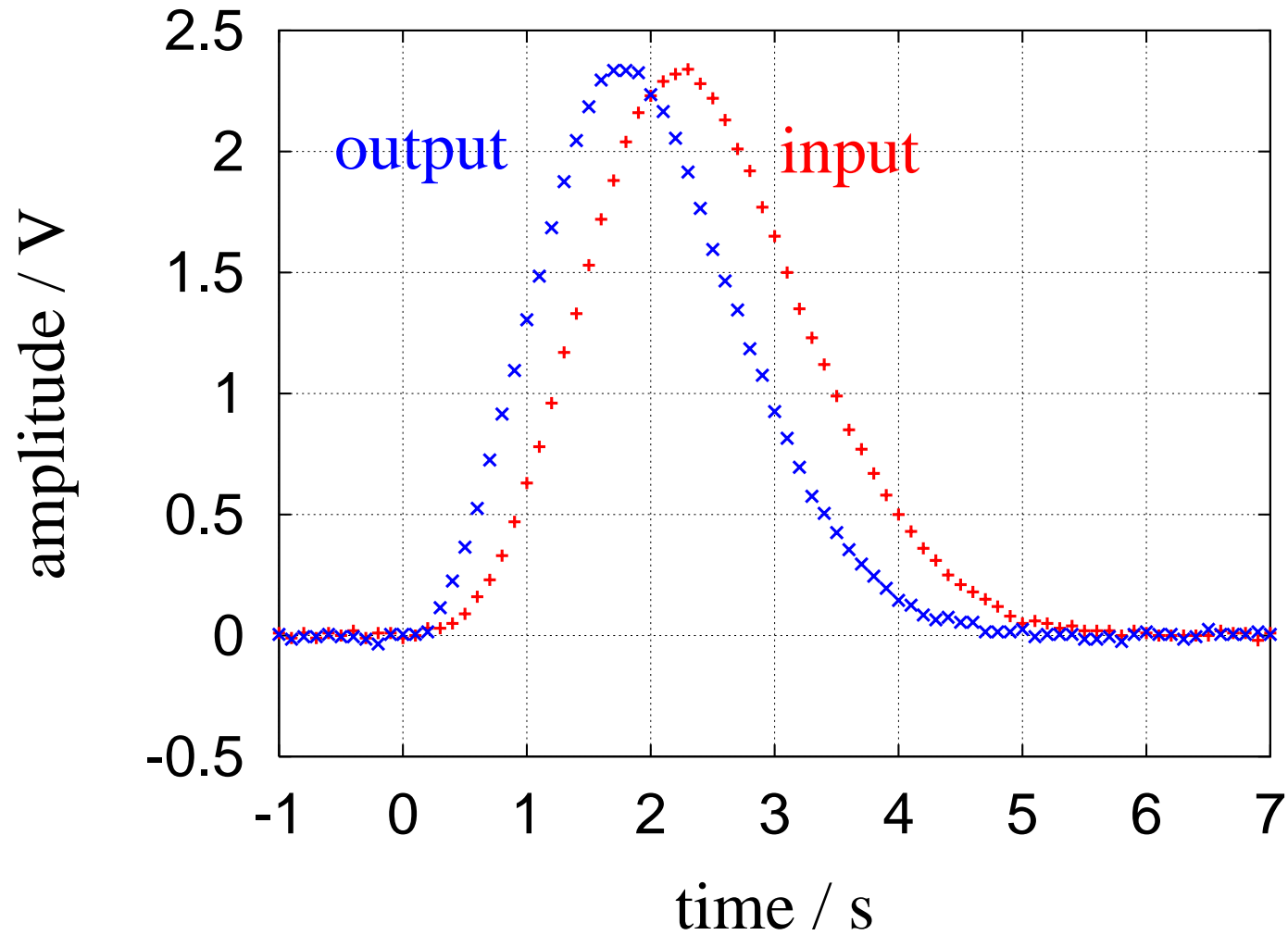

Interference in time domain

In time domain (cf. $H(\omega) = 1 + i\omega T$)

$$v_{\text{out}}(t) = \left(1 + T \frac{d}{dt} \right) v_{\text{in}}(t) = v_{\text{in}}(t) + T \frac{dv_{\text{in}}}{dt}(t)$$

Two terms interfere — constructively at the leading edge and destructively at the trailing edge.

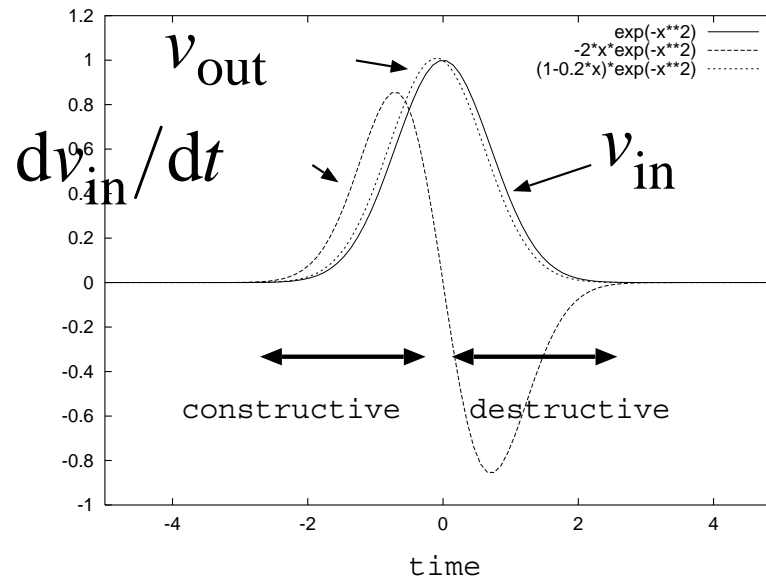

All-passive circuit

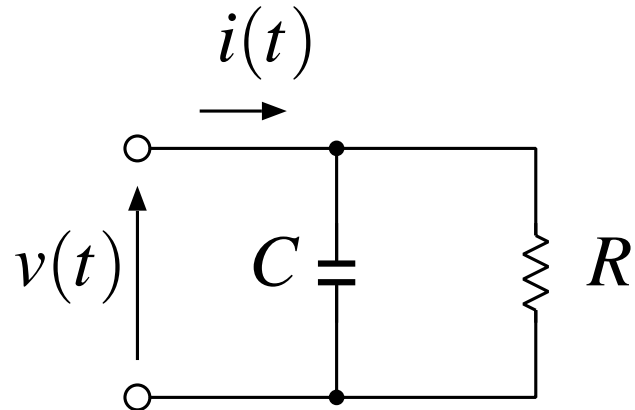

$$i(t) = \frac{1}{R}v(t) + C\frac{d}{dt}v(t) = \frac{1}{R}\left(1 + RC\frac{d}{dt}\right)v(t)$$

This circuit gives negative group delays, if we consider $v(t)$ as the input and $i(t)$ as the output.

Unbalanced interferometer

Reflectivity of beam splitters: $R = 1/2 - \rho$, Delay: $\tau = 2L/c$

$$E_{\text{dark}}(t) = (1 - R)E_{\text{in}}(t) - RE_{\text{in}}(t - \tau) \sim 2\rho \left(1 + \frac{\tau}{4\rho} \frac{d}{dt} \right) E_{\text{in}}(t)$$

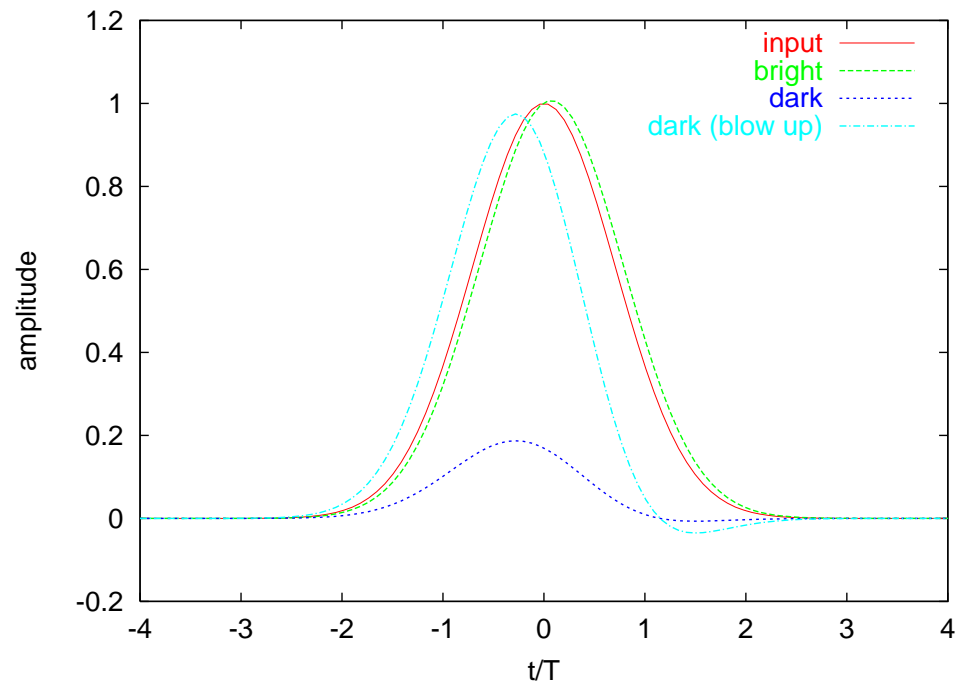
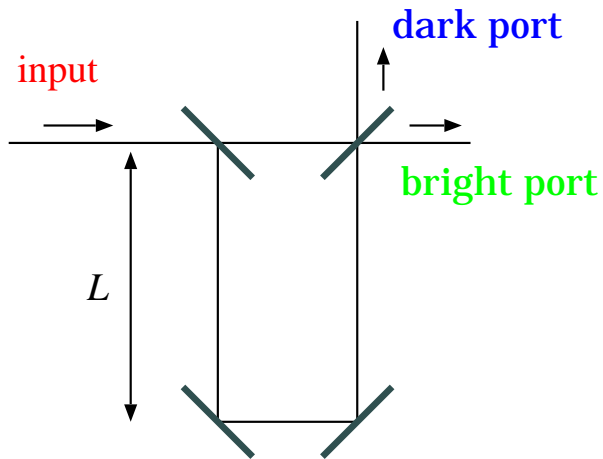

$\rho = 0.08$, $\tau = 0.15T$, T : gaussian pulse width

Cascading — for larger advancement

Transfer function for n stages: $H^n(\omega) = (1 + i\omega T)^n$

$$A^n(\omega) \sim 1 + \frac{n(\omega T)^2}{2} = 1 + \frac{(\sqrt{n}\omega T)^2}{2}, \quad n\phi(\omega) \sim n\omega T$$

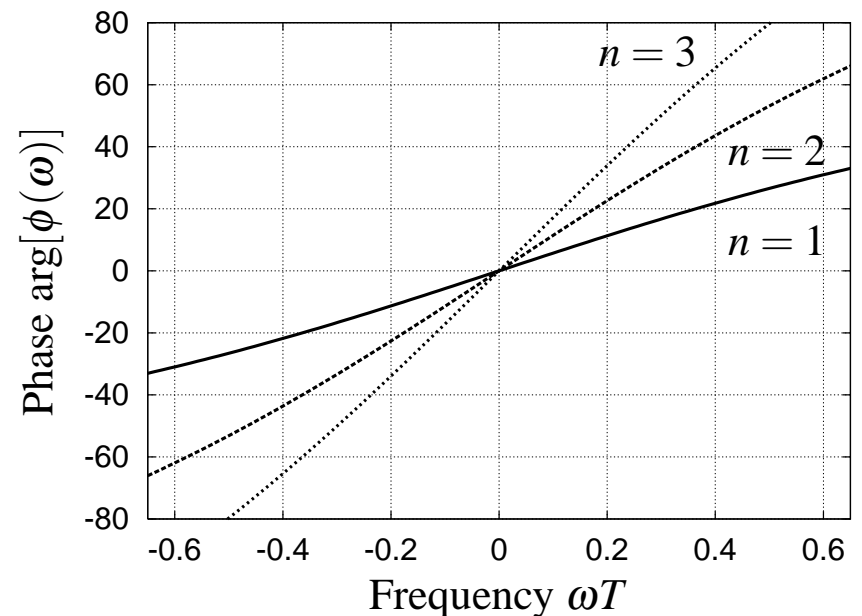
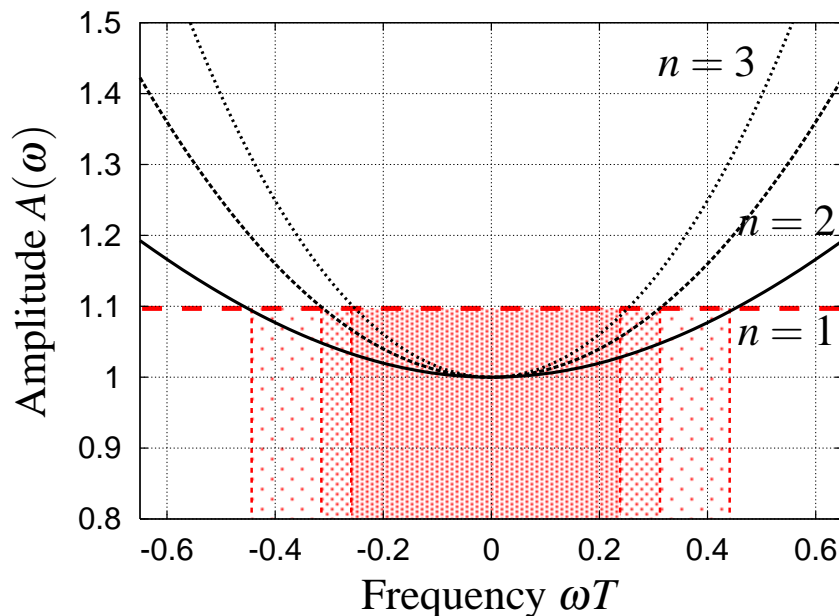

Bandwidth is reduced as n increased.

Cascading (2)

- Usable bandwidth decreases as $1/\sqrt{n}$, if T is given.
- For a given input pulse (T_w), $T = CR$ must be reduced as T_w/\sqrt{n} .
- Total advancement scales $1/\sqrt{n}$;

$$-t_d \propto n \times (T_w/\sqrt{n}) = \sqrt{n}T_w$$

- Order m of lowpass filters must be increased accordingly;

$$m > n$$

Cascading, $n = 10$

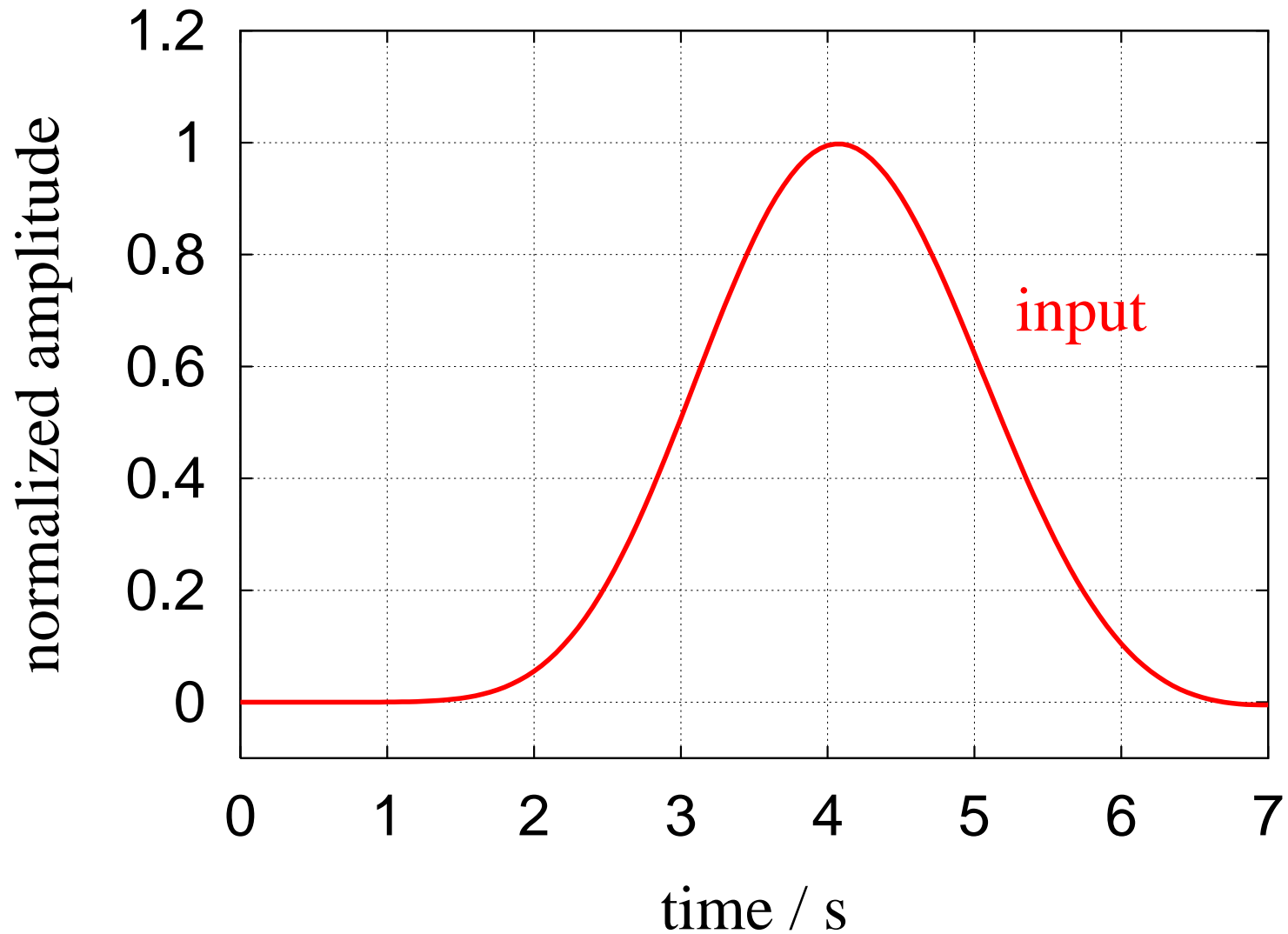

Cascading, $n = 10$

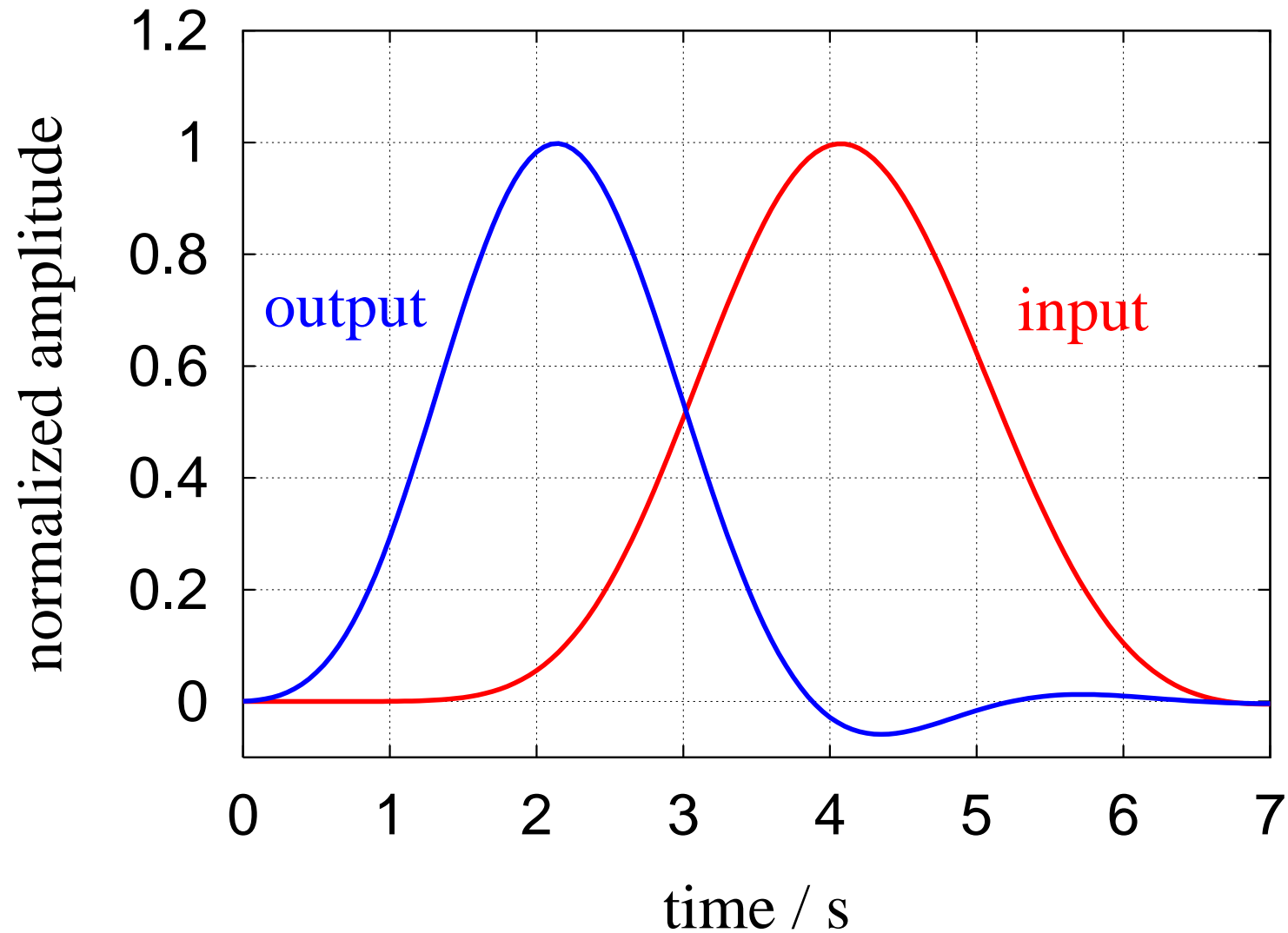

Problems in cascading

It is possible to increase the advancement as large as the pulse width or more, but

- The advancement increases slowly; $1/\sqrt{n}$.
- The order m of lowpass filters must be increased.
- The system becomes very sensitive to noises. (A huge gain outside of the band)

Pushing the limit

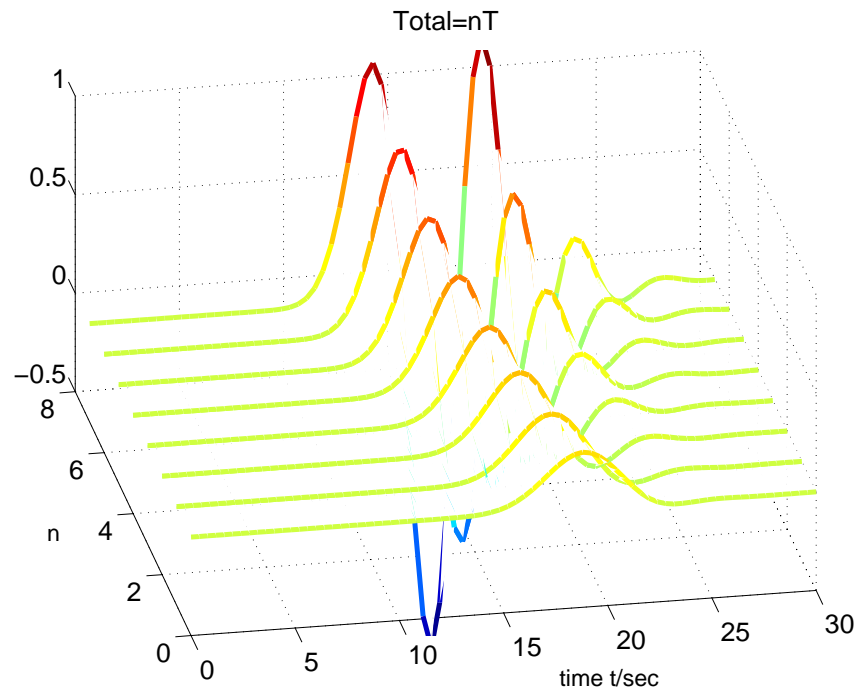

Simple-minded cascading

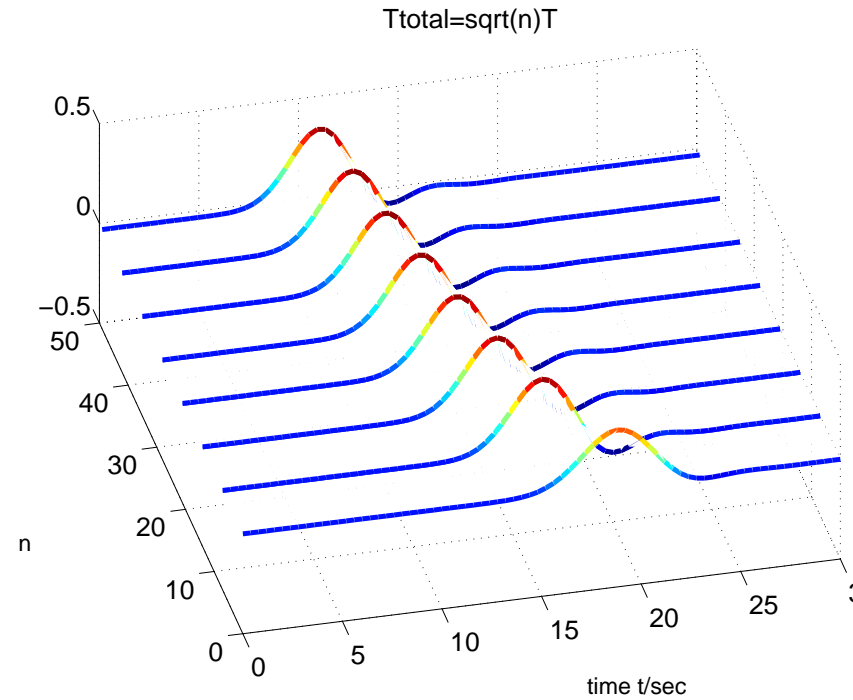

$1/\sqrt{n}$ cascading

Pushing the limit — two pulse case

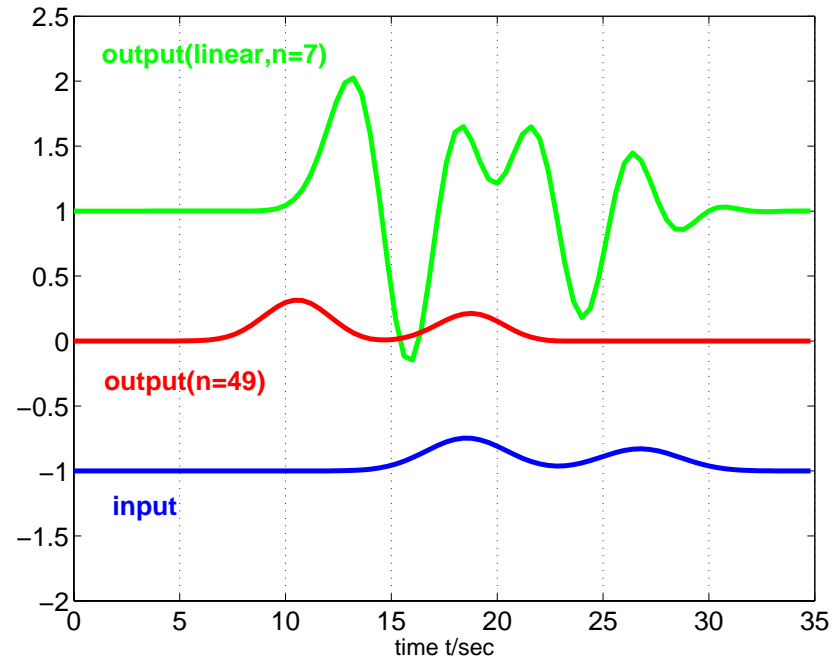

Out-of-band gain

Outside gain — Significant obstacle toward large n .

- Realistic transfer function (finite gain at $\omega = \infty$):

$$H(\omega) = \frac{1 + i\omega T}{1 + i\omega T / \alpha}, \quad \alpha > 1$$

$$\phi(\omega) = \omega(1 - \alpha^{-1})T$$

$$A(\omega) = \sqrt{\frac{1 + (\omega T)^2}{1 + (\omega T / \alpha)^2}} \sim \begin{cases} 1 & (\omega = 0) \\ \alpha & (\omega = \infty) \end{cases}$$

- For $\alpha = 0.5$, $n = 50$; $A^n(\infty) = \alpha^n = 2^{50} = 10^{15}$!

Role of lowpass filters

- Predictability — Your move will be predicted if some restrictions are imposed.

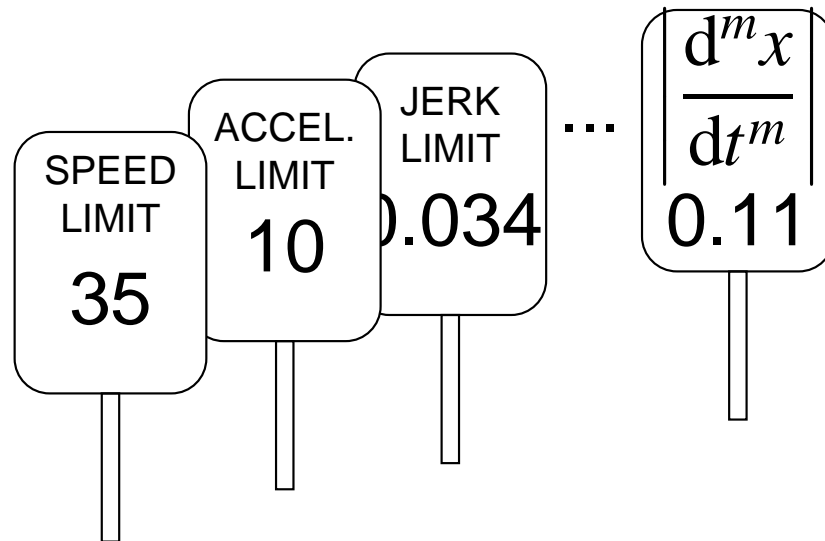

- Resemblance of functions — A negative delay circuit reveals the difference.

$$\text{dist}(f, g) = \max_{0 \leq j \leq m} \left\| \frac{d^j f}{dt^j} - \frac{d^j g}{dt^j} \right\|$$

Role of filters (2)

On the condition $m > n$

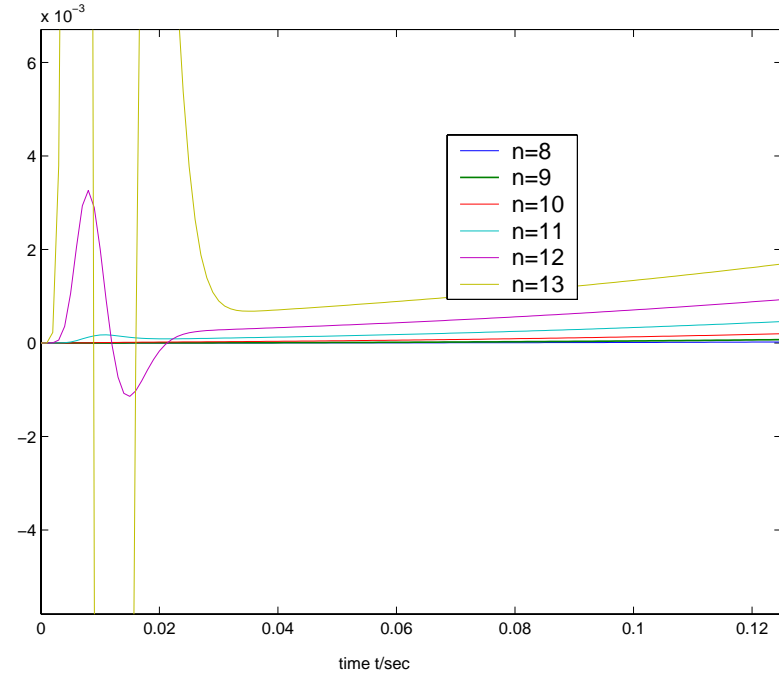
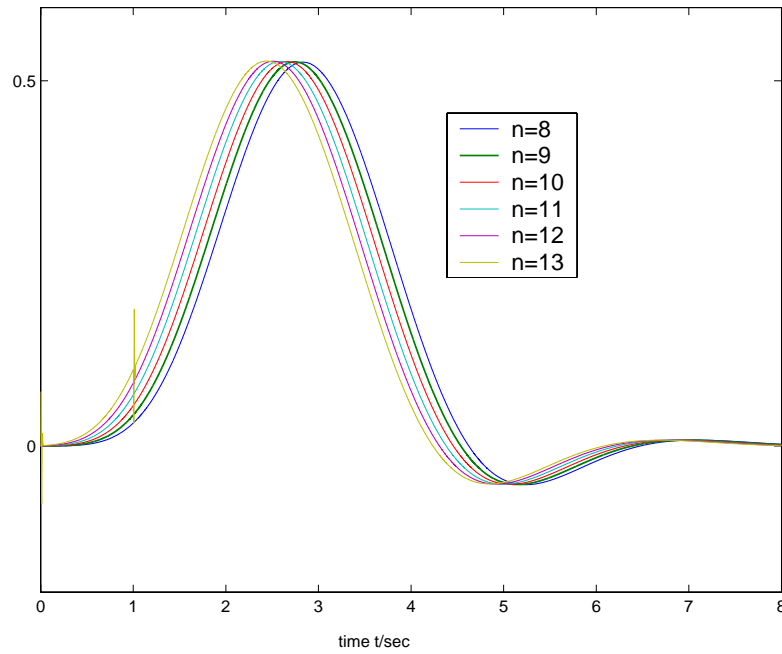

Causality

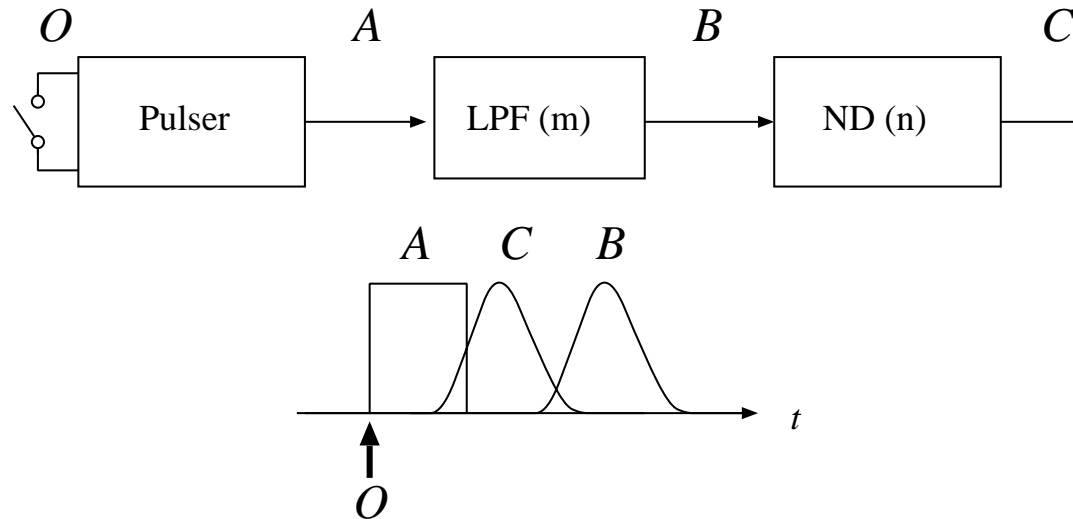

- Causal relation in a casual sense

$$O \rightarrow A \rightarrow B \overset{?}{\rightarrow} C$$

- Causal relation in a strict sense

$$A \Leftrightarrow B \Leftrightarrow C \quad (\Leftrightarrow A)$$

Conclusion

- A stand-alone (battery-operated) demonstration box
 - Battery operated
 - No extra equipment such as an oscilloscope or a function generator needed
- Large negative delays ~ 0.5 s are achieved experimentally.
 - 25% of pulse width
- Larger delay with cascading is possible (in principle).
 - Advancement can be larger than the pulse width.
- Filter stage plays an essential role.
 - The start of event (cause) is located before the filters.