

**A TALE OF TWO  
GLASSES (a Coulomb glass  
and a glass-forming liquid)  
AND THEIR STRUGGLE  
TO REACH EQUILIBRIUM**

Clare C. Yu  
University of California, Irvine

**Time Dependent  
Development of the  
Coulomb Gap**

Clare C. Yu  
University of California, Irvine

(Reference: C. Yu, Phys. Rev. Lett. **82**, 4074 (1999))

## Coulomb Glass

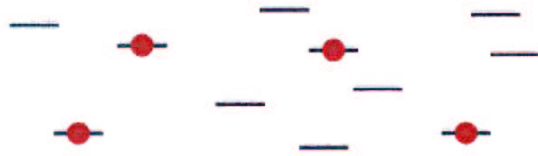

A Coulomb glass is an amorphous insulator with randomly placed electrons that have Coulomb interactions. Examples are doped semiconductors and disordered metals. In these systems the electrons see a random potential and are localized.

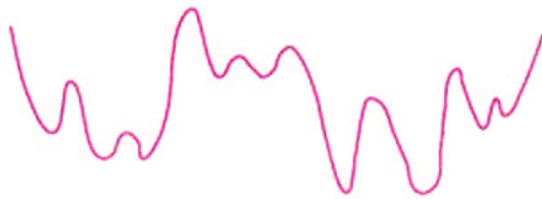

We can model this situation with randomly placed sites that have random energies  $\phi_i$ . Electrons sit on some of these sites and interact with one another via long range Coulomb interactions. This is called a Coulomb glass.

$$H = \sum_i \phi_i n_i + \sum_{i>j} \frac{e^2}{\kappa r_{ij}} n_i n_j$$

where  $\kappa$  is the dielectric constant, and  $n_i$  is the occupation number. Electrons can hop from site to site often with the help of phonons (phonon assisted hopping).

## Coulomb Gap

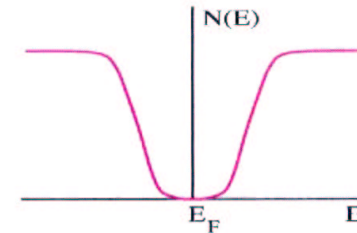

Coulomb interactions between localized electrons in a Coulomb glass result in a Coulomb gap in the single particle density of states that is centered at the Fermi energy. The Coulomb gap makes the ground state stable with respect to single electron hops. (Pollak, Efros, Shklovskii) Think of a spin glass analogy where an occupied site has spin up and an unoccupied site has spin down. Let  $P(h)$  be the distribution of local fields  $h$ . If  $P(h = 0) \neq 0$ , then the spins with  $h = 0$  can flip easily, which causes other spins to flip and an avalanche occurs. So stability of the ground state requires  $P(h = 0) = 0$ .

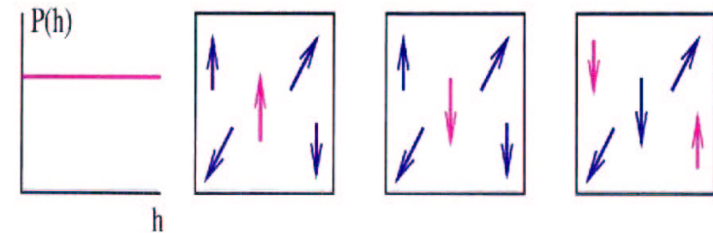

## Electron Hopping in a Coulomb Glass

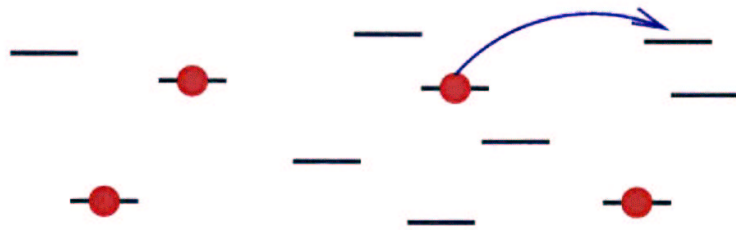

Electrons typically move very quickly in metal, but a Coulomb glass can have low electron hopping rates, leading to very long relaxation times. The electron hopping rate between two sites  $i$  and  $j$  depends on the site separation  $r_{ij}$ , the difference in site energies  $(\phi_i - \phi_j)$ , the change in Coulomb energy, and phonon hopping assistance.

## Experiment

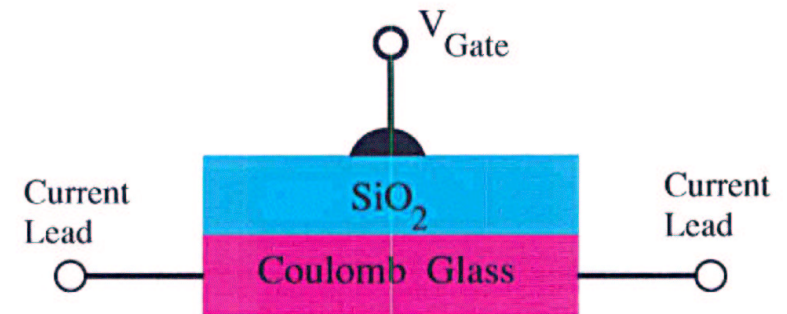

Long relaxation times have been seen in Coulomb glasses. In the experiments the Coulomb glasses were thin disordered semiconducting and metallic films. The electron density, and hence chemical potential, were regulated as a function of the gate voltage  $V_{Gate}$ . The conductance  $G$  was measured as a function of  $V_{Gate}$ . (Ovadyahu, Pollak, Vaknin, Martinez-Arizala, Goldman)

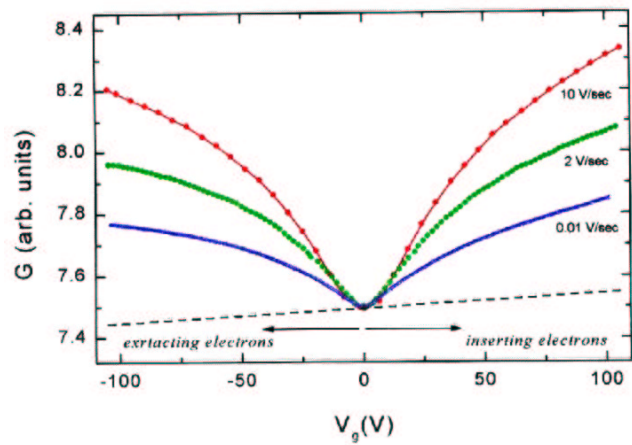
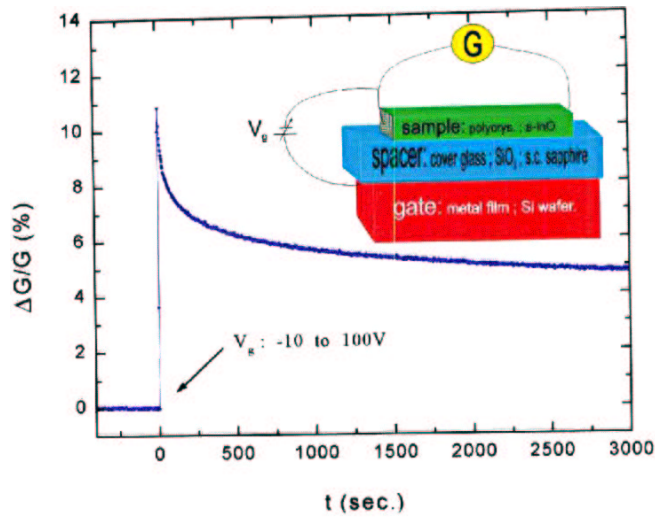

similar phenomena was observed also in:  
*granular gold*      C. J. Adkins  
*granular Lead*      A. M. Goldman

(J. Phys. C, 17, 4633, 1984)  
 (PRB 57, R670, 1998)

Vaknin et al.

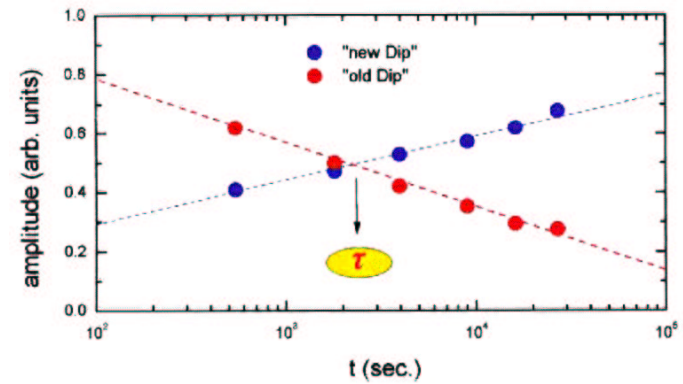
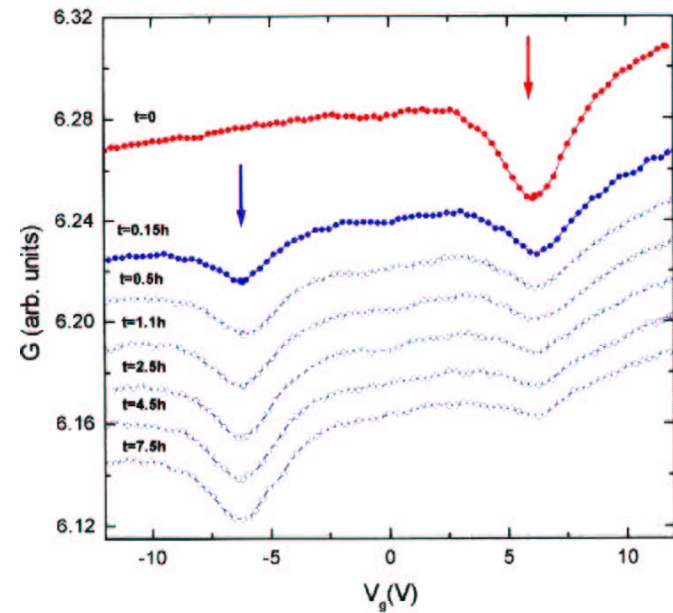

Vaknin et al.

### Scenario

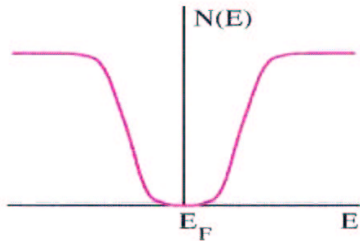

We identify the dip in the conductance with the Coulomb gap in the density of states because the value of the conductance depends on the density of states at the Fermi energy  $\mu$ . When the density of states at the Fermi energy increases, there are more states to which an electron can hop. We identify sweeping the gate voltage with varying  $\mu$  without allowing time for equilibration. When the gate voltage is changed,  $\mu$  changes, and time dependent relaxations arise because the system must dig a new hole in the density of states at the new Fermi energy and remove the old hole at the old Fermi energy.

### Time Development of Coulomb Gap

We expect that when the gate voltage  $V_g$  is changed at time  $t = 0$ , the electron density changes and hence the Fermi energy  $\mu$  changes. As a result of these changes, the system jumps out of the old hole and digs a new hole centered at the new Fermi energy.

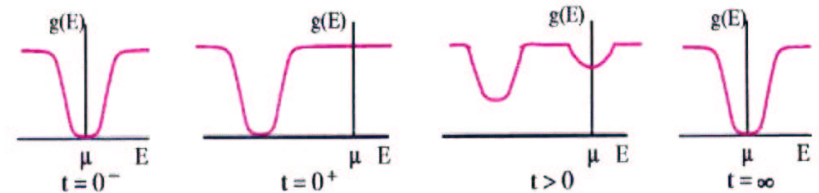

The amplitude of the hole grows roughly logarithmically in time  $g(E = \mu, t) \sim \ln t$ .

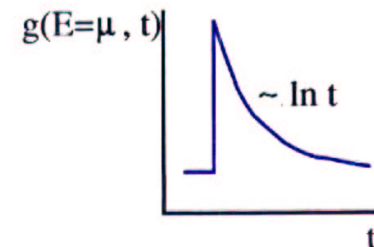

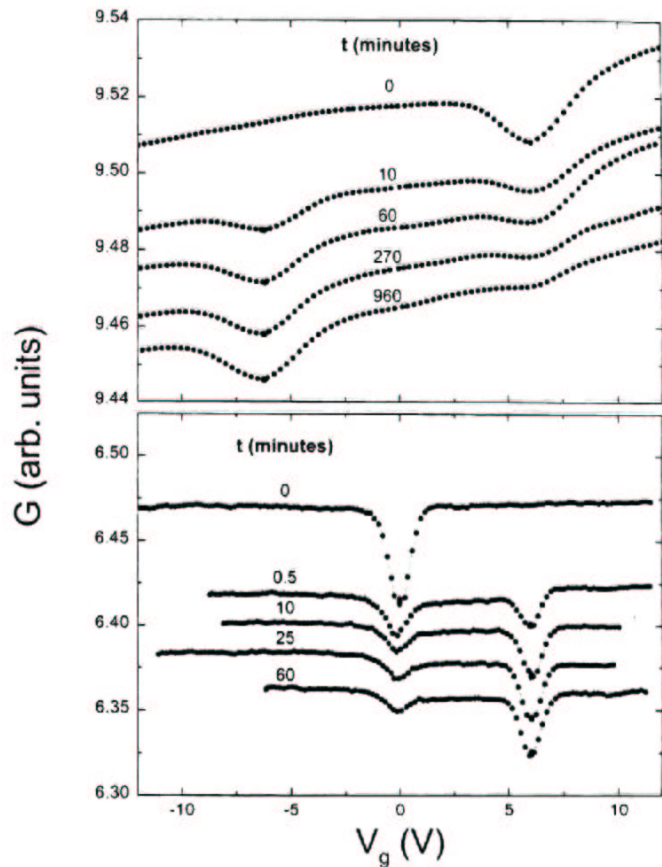

FIG. 1. Conductance versus gate voltage for a TDE of two samples with  $n$  of  $4 \times 10^{20}$  and  $1 \times 10^{20} \text{ cm}^{-3}$  (upper and lower graphs, respectively). In each graph, the first trace was taken  $\approx 12$  hours after the initial cooldown with  $V_g^0$  imposed (6 and 0 V for the upper and lower graphs, respectively). Then,  $V_g^n$  was applied and maintained between subsequent sweeps ( $-6$  and  $6$  V, respectively). The other traces (shifted for clarity) are labeled by the time elapsed since  $V_g^n$  was first applied. Typical scan rate was  $0.1\text{--}0.2$  V/s.

Vaknin et al.

## Calculation

We assume that the Coulomb interactions are turned on at time  $t = 0$ . The Hamiltonian for a Coulomb glass is

$$H = \sum_i \phi_i n_i + \sum_{i>j} \frac{e^2}{\kappa r_{ij}} n_i n_j \theta(t)$$

where  $\kappa$  is the dielectric constant,  $n_i$  is the occupation number.  $\phi_i$  is a random onsite energy.

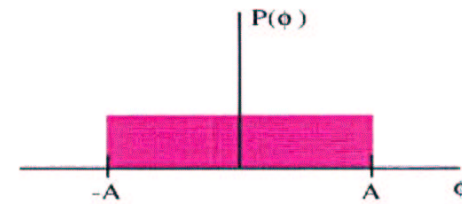

The stability of the ground state to a single electron hopping from site  $i$  to site  $j$  requires

$$\Delta_i^j = \epsilon_j - \epsilon_i - \frac{e^2}{\kappa r_{ij}} > 0$$

where the single-site energy  $\epsilon_i = \phi_i + \sum_{j>i} \frac{e^2}{\kappa r_{ij}} n_j$ . We subtract from the density of states the "bad" states which do not satisfy the stability condition:

$$\begin{aligned} g(\epsilon, t) &= g_o(1 - \text{bad states}) \\ &= g_o \prod_{j>i} \left( 1 - a_o^3 \int_0^A d\epsilon' g(\epsilon', t) \theta(-\Delta_i^j) \theta(t - \tau_{ij}) \right) \end{aligned}$$

where  $\tau_{ij}^{-1}$  is the hopping rate. This leads to a self-consistent equation for  $g(\epsilon, t)$  (Baranovskii et al.).

## Density of States Equation

The self-consistent equation for the density of states is

$$g(\varepsilon, t) = g_0 \exp \left\{ -\frac{1}{2} \int_0^A d\varepsilon' g(\varepsilon', t) \int_{a_0}^{\infty} dr 4\pi r^2 \theta\left(\frac{e^2}{\kappa r} + \varepsilon - \varepsilon'\right) \theta(t - \tau) \right\}$$

where  $\tau^{-1}$  is the hopping rate. (Baranovskii et al.).

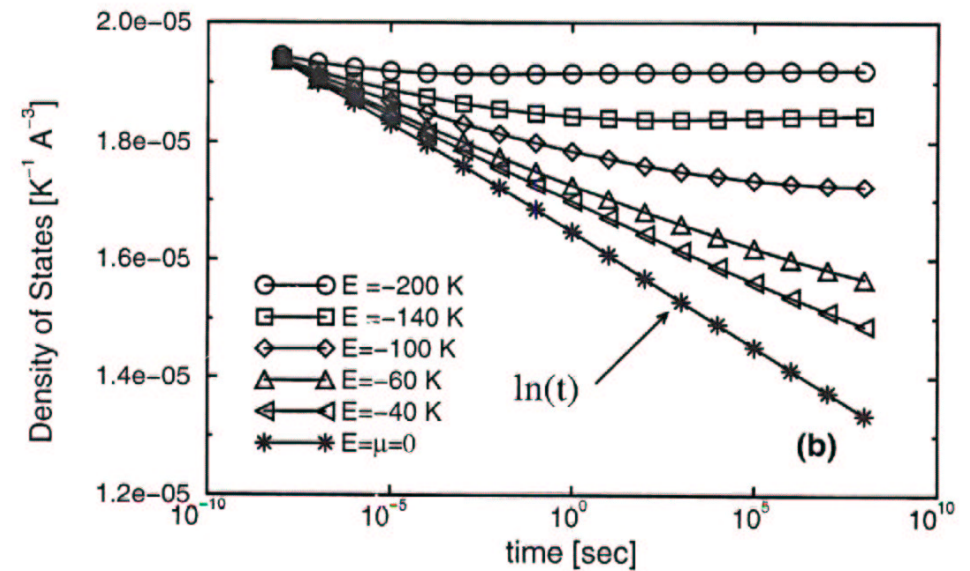
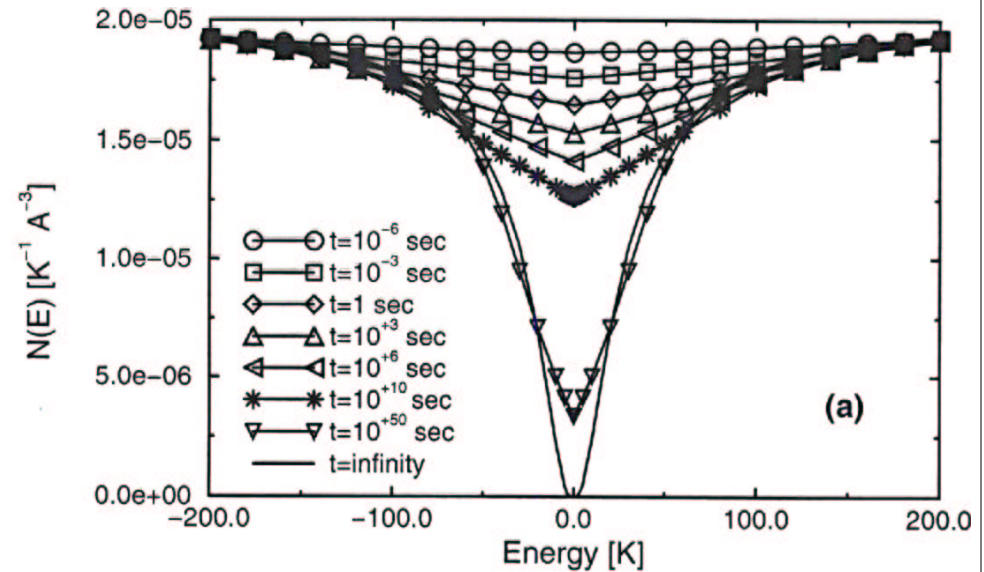

## Conductivity

The conductivity  $\sigma$  due to variable range hopping depends on how many states there are to hop into, i.e., on the density of states at the Fermi energy.

$$\sigma = \sigma_o \exp \left[ - \left( \frac{T_o}{T} \right)^{\frac{1}{4}} \right]$$

where  $T_o = \alpha / (k_B g(\mu) a^3)$ ,  $\alpha$  is a numerical constant,  $a$  is the effective Bohr radius, and  $g(\mu)$  is the density of states at the Fermi energy. Rapid sweeps over gate voltage scan the density of states. The exponent of 1/4 is appropriate for a linear density of states.

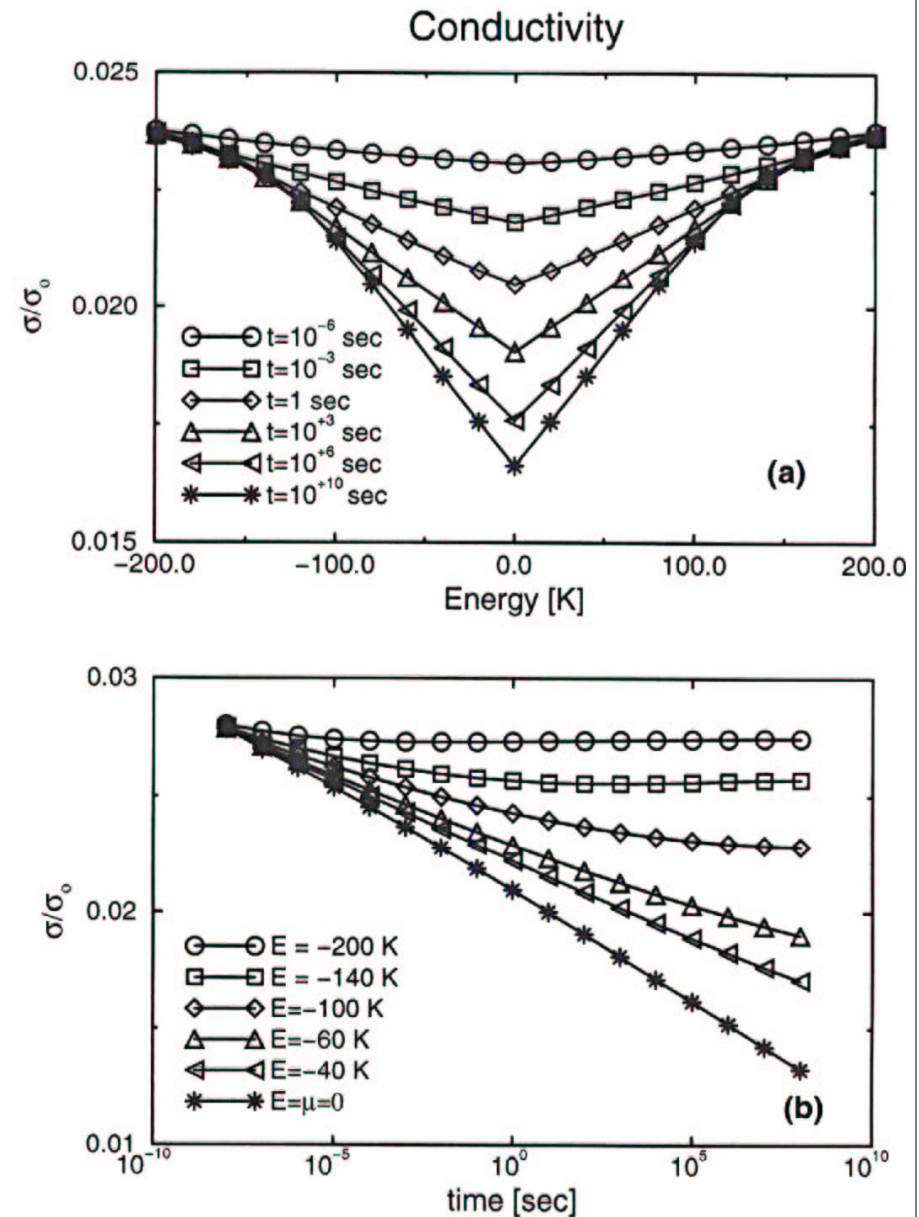
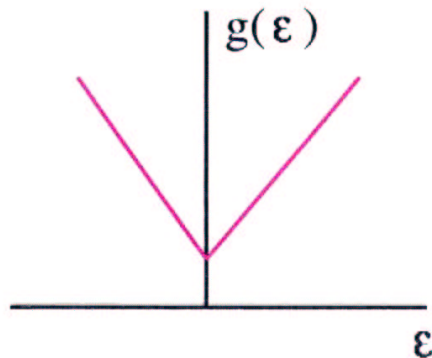



## Conclusions

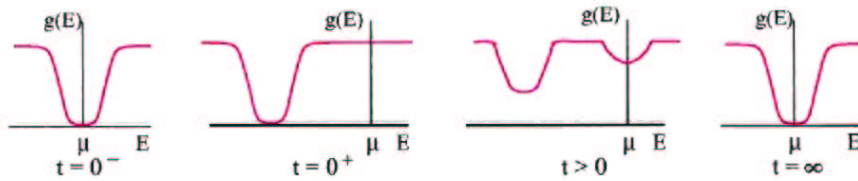

We have shown that the time development of the Coulomb gap in a Coulomb glass can involve very long relaxation times due to electron rearrangement and hopping. The relaxation rate goes as  $\ln(t)$ . These results are consistent with recent conductance experiments on thin semiconducting and metallic films.

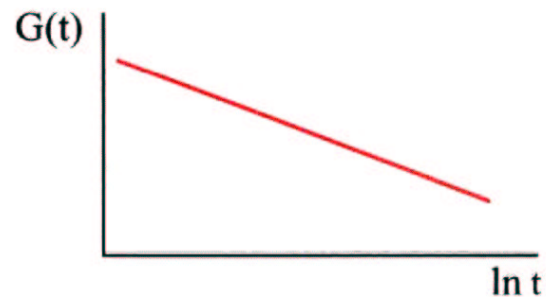

# Equilibration and Frequency Dependence of the Specific Heat of Glass Forming Liquids

Hervé M. Carruzzo and Clare C. Yu  
University of California, Irvine

## Signatures of the glass transition

- **Specific Volume  $V_{sp}$  and Entropy vs.  $T$ :** Below  $T_g$  the specific volume  $V_{sp}$  of the glass decreases more slowly than in the liquid state with decreasing temperature. The entropy has similar behavior.
- **Specific Heat vs.  $T$**  is a step-like function.
- **Viscosity** increases exponentially. Vogel–Fulcher equation:

$$\eta = \eta_0 \exp\left(\frac{A}{T - T_0}\right)$$

- **Nonexponential Relaxation** in response to perturbations which is often characterized by a stretched exponential:

$$\phi(t) = e^{-(t/\tau)^\beta} \quad \text{where } \beta \leq 1$$

For example, if an electric field is applied to orient the molecules, and then the field is turned off, the distribution of the orientation of the molecules approaches equilibrium in this fashion.

## Introduction to the Glass Transition

When a liquid is cooled, it may crystallize at temperature  $T_m$ . If it avoids crystallization and remains liquid below  $T_m$ , it is called a supercooled liquid. As the temperature is lowered, the molecules become more and more sluggish, and the viscosity  $\eta$  grows. Eventually the time it takes for molecules to rearrange substantially exceeds experimental time scales. At this point the liquid “falls out of equilibrium” and becomes a glass. We denote the glass transition temperature by  $T_g$ .

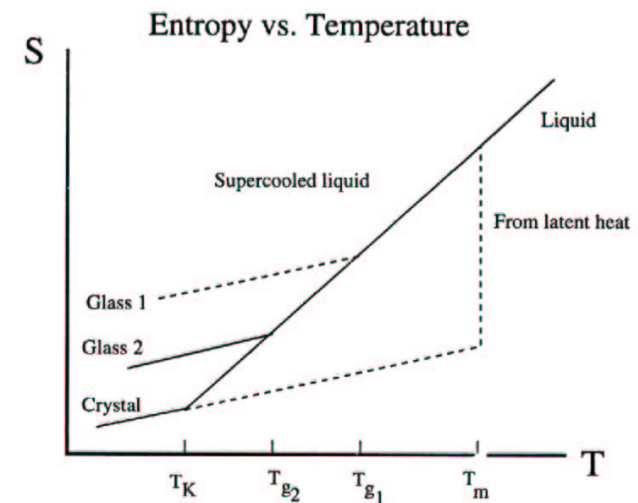
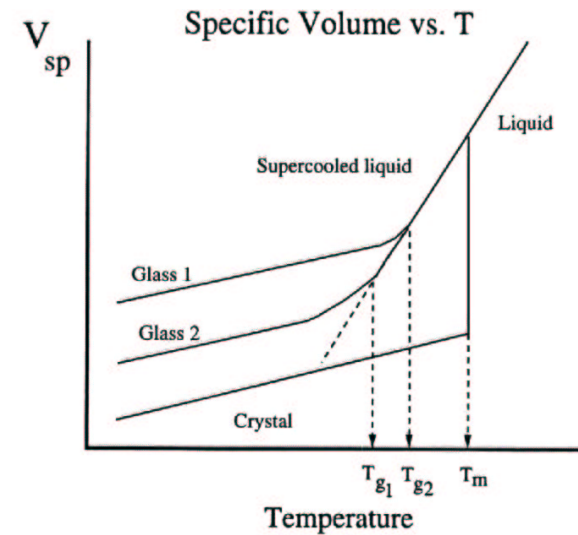

Specific Heat vs. Temperature

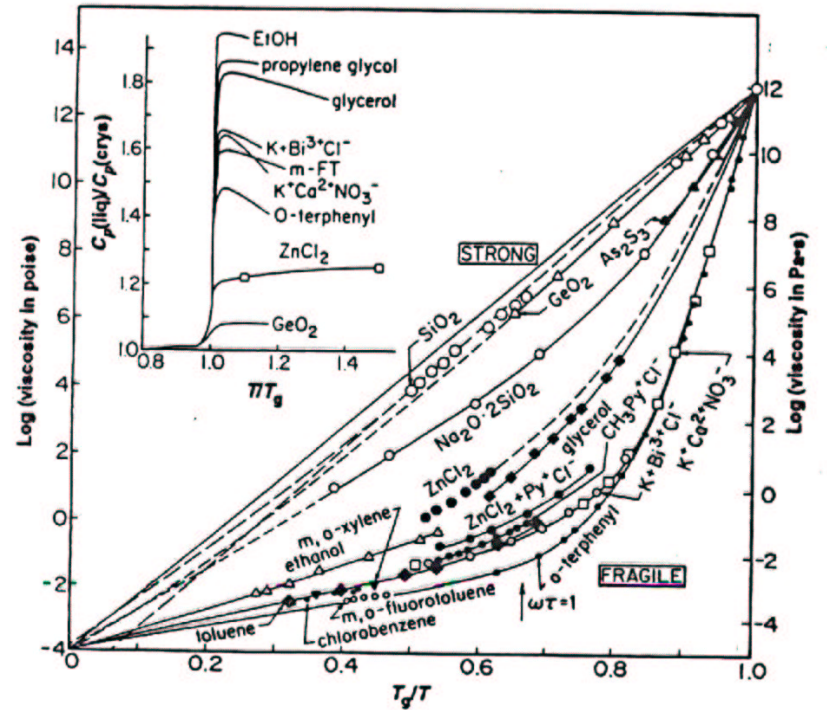
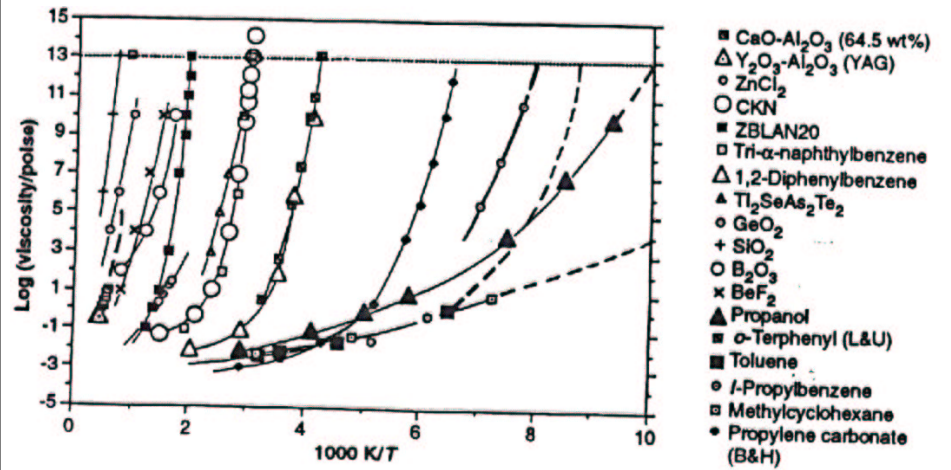
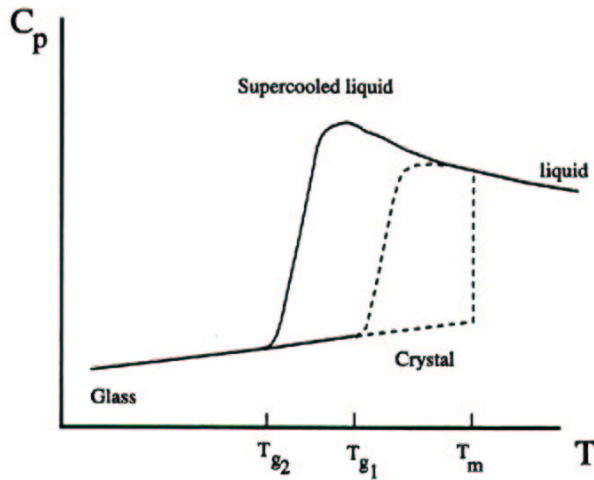

## Introduction to the Glass Transition

When a liquid is cooled, it may crystallize at temperature  $T_m$ . If it avoids crystallization and remains liquid below  $T_m$ , it is called a supercooled liquid. As the temperature is lowered, the molecules become more and more sluggish, and the viscosity  $\eta$  grows. Eventually the time it takes for molecules to rearrange substantially exceeds experimental time scales. When the time scale for reaching equilibrium exceeds the observation time, the liquid “falls out of equilibrium” and undergoes a glass transition. Like many complex systems, such as proteins and neural networks, the dynamics of such a system is strongly influenced by the potential energy landscape. The energy landscape can be used to describe the three ways in which a system can fall out of equilibrium.

## How a System Can Fall Out of Equilibrium

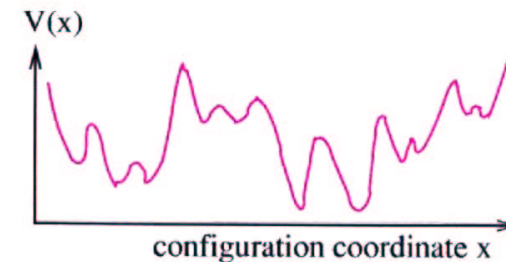

- System becomes trapped in a metastable minimum.
- Aging: System proceeds slowly toward more probable regions of phase space. Aging time =  $\alpha$  relaxation time = time to forget initial configuration
- System that is *not* aging proceeds so slowly through the energy landscape that it does not have time to accumulate enough statistically independent measurements.

### Consequences of Insufficient Averaging

- Specific Heat Peak** We find that a glass forming liquid can undergo a glass transition, as signaled by a peak in the specific heat  $C_V$  vs.  $T$ , that is due to insufficient averaging by a system that is not aging.

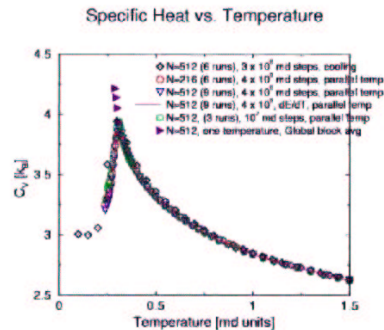

- Frequency Dependent Specific Heat** Lack of sufficient averaging produces a frequency dependent specific heat that increases as the frequency decreases.

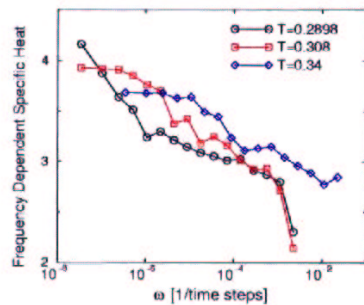

### Model of a Glass Forming Liquid

We study a 50 – 50 binary mixture of big and small soft spheres (3D). The Hamiltonian is

$$H = H_{KE} + \epsilon \sum_{i \neq j} \left( \frac{\sigma_{ij}}{r_{ij}} \right)^{12} \quad \sigma_{ij} = \frac{1}{2}(\sigma_i + \sigma_j)$$

$\sigma_i = \sigma_{A,B}$ .  $\sigma_A$  and  $\sigma_B$  set the range of interaction. The choice  $\sigma_B/\sigma_A = 1.4$  prevents crystallization.  $\epsilon$  sets the energy scale of the interaction. The system is at a temperature  $T$  and has a density  $\rho_0 = N/V = 0.6$  where  $N$  is the total number of particles and  $V = L^3$  is the volume.

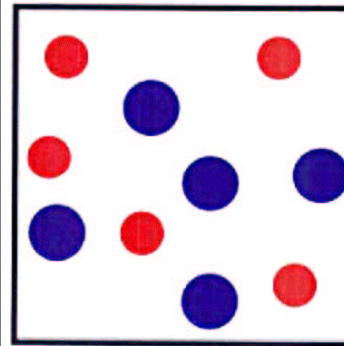

The origin is at the center of the box and the edges at  $\pm L/2$ . Periodic boundary conditions are used.

## Relaxation Time

We use the full intermediate scattering function  $F(k, t)$  to find the relaxation time  $\tau$ .  $\tau$  is defined by  $F(k, \tau) = 1/e$ .  $\tau$  is a measure of the time it takes for a configuration to lose its memory of a previous configuration.

$$F(\vec{k}, t) = \frac{1}{N} \langle \rho_{\vec{k}}(t) \rho_{-\vec{k}}(0) \rangle$$

where the Fourier transform of the density

$$\rho_{\vec{k}}(t) = \sum_{i=1}^N e^{-i\vec{k} \cdot \vec{r}_i(t)}$$

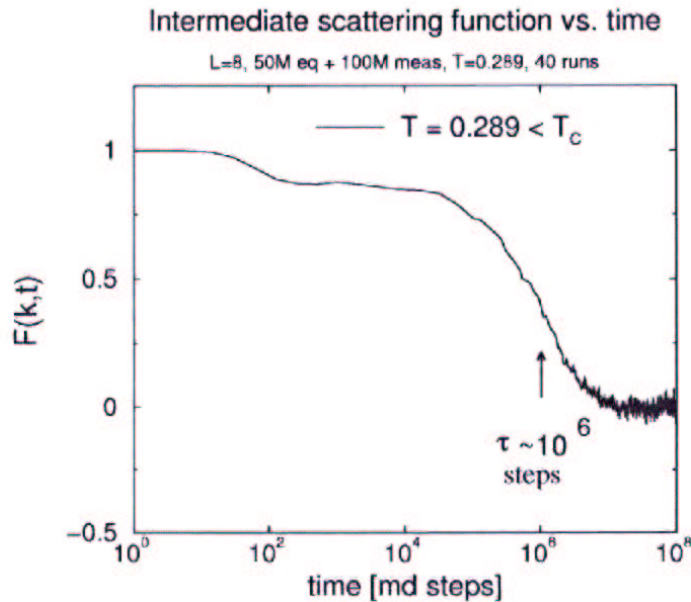

## Mode Coupling $T_C$

We use the self intermediate scattering function  $F_s(k, t)$  to find the relaxation time  $\tau$ .

$$F_s(\vec{k}, t) = \frac{1}{N} \left\langle \sum_{i=1}^N e^{i\vec{k} \cdot (\vec{r}_i(t) - \vec{r}_i(0))} \right\rangle$$

$\tau$  is defined by  $F(k, \tau) = 1/e$ .  $\tau$  is a measure of the time it takes for a configuration to lose its memory of a previous configuration. Naive mode coupling theory predicts that the relaxation time will diverge at  $T = T_C$  according to

$$\tau \sim \frac{1}{(T - T_C)^\gamma}$$

Our fit yields  $T_C = 0.303$ . (Mode coupling theory breaks down at  $T \lesssim T_C$ .)

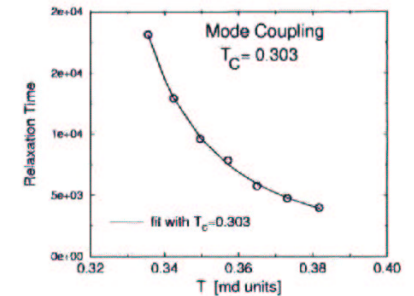
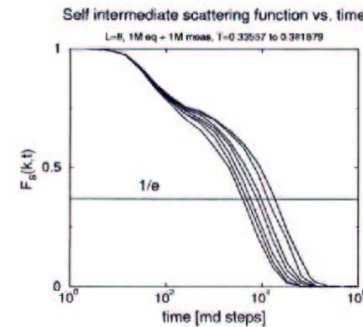

## Kinetic versus Thermodynamic Transition

**Kinetic Transition:** In a kinetic transition ergodicity is broken and the system falls into some metastable minimum in the energy landscape. However thermodynamic properties remain unchanged across the transition.

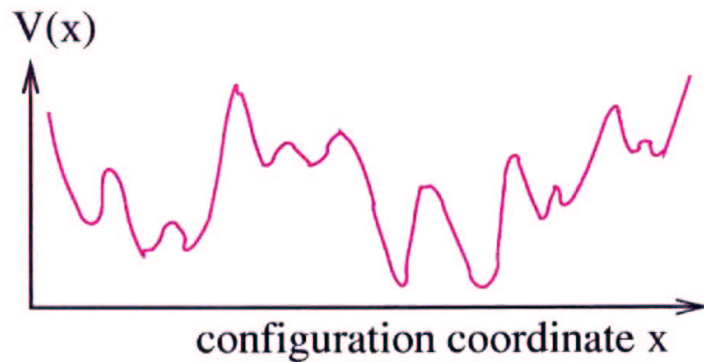

**Thermodynamic Transition:** Thermodynamic averages involve all of phase space with a proper Boltzmann weighting. If there is an underlying thermodynamic transition, then such averages should diverge or have a discontinuity of some type.

$$\langle A \rangle = \frac{1}{Z} \sum_i A_i e^{-\beta E_i}$$

## Parallel Tempering

To try to avoid becoming trapped in an energy basin, we use parallel tempering in which molecular dynamics simulations at different temperatures are run in parallel. Configurations at different temperatures are allowed to switch with a Boltzmann-like probability every few md steps.

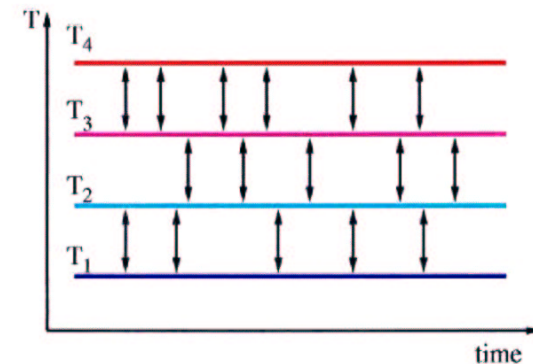

This allows averaging over different minima in the energy landscape. A particular realization of the system in a minimum at low temperatures can work its way up to high temperatures; anneal; and then go into another low temperature minimum.

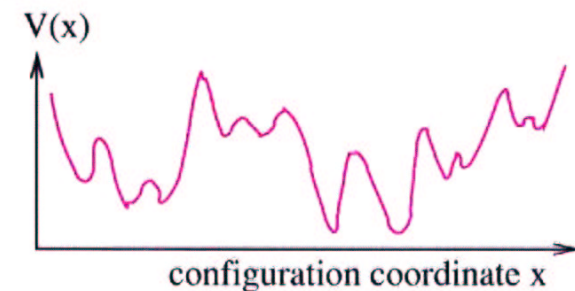



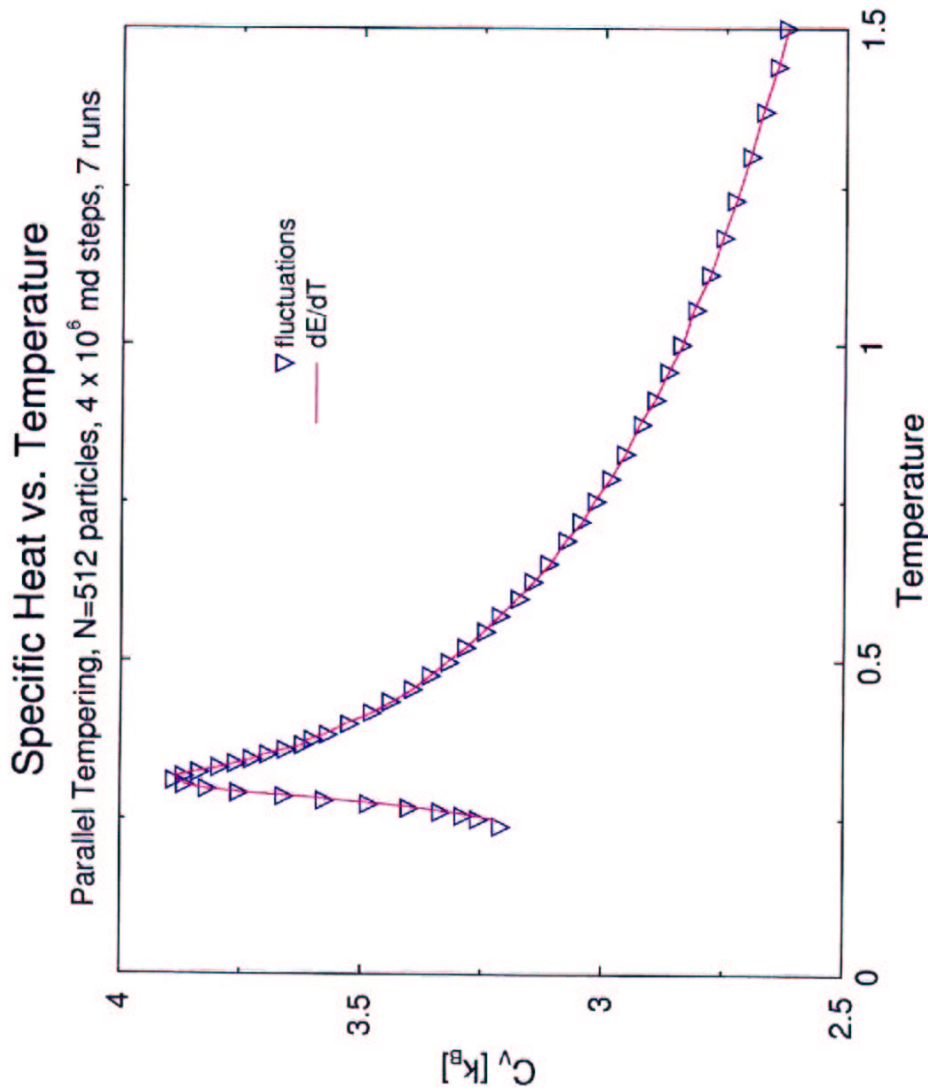

### Specific Heat Peak

Parallel tempering or cooling a glass forming liquid produces a glass transition, as signaled by a peak in the specific heat  $C_V$  vs.  $T$ .

### Specific Heat vs. Temperature

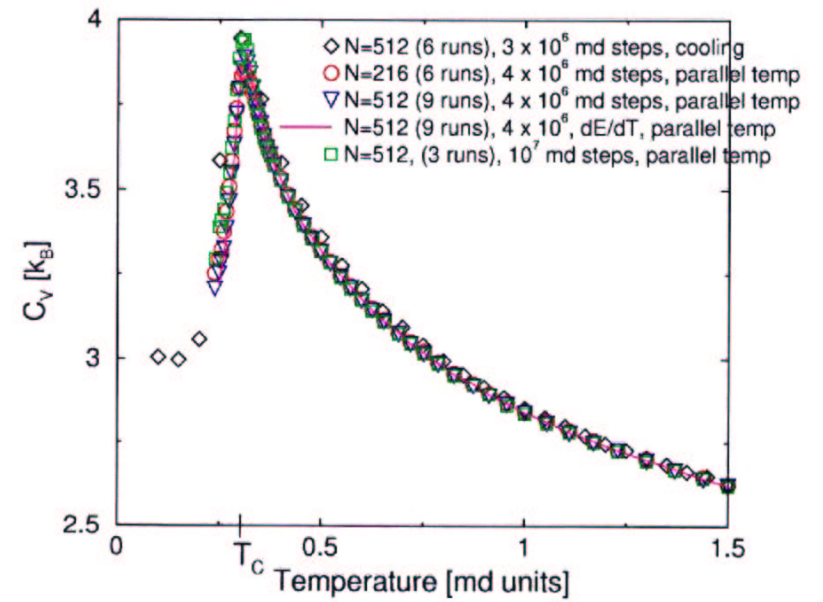

We can show that the peak is a nonequilibrium effect due to insufficient averaging.

### Inherent Structures

An inherent structure is the configuration of the particles at the bottom of a basin in the energy landscape (Stillinger and Weber).

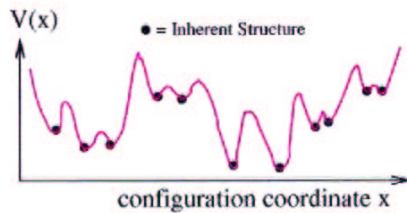

To see how well we are equilibrating, we can plot the inherent structure energy  $e_{IS}$  per particle vs. temperature. If we are stuck in an energy basin at low temperature,  $e_{IS}$  vs.  $T$  will be flat. If  $e_{IS}$  drops as  $T$  decreases, then we are visiting many basins. Thanks to parallel tempering, even at temperatures below the peak, the system is visiting many basins implying that the system is not trapped in a basin of the energy landscape.

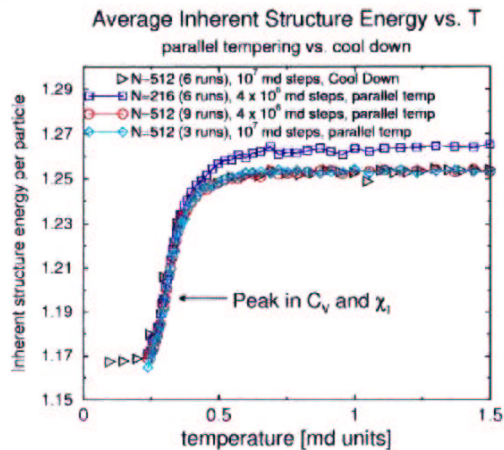

### Average Inherent Structure Energy vs. T

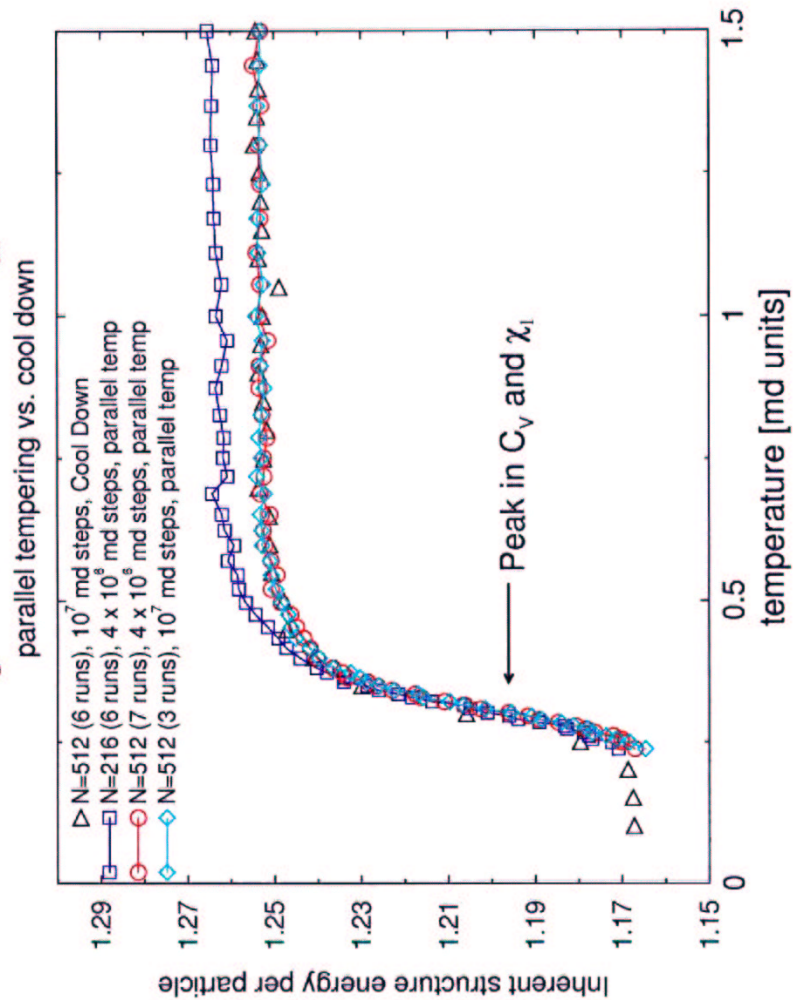

### Single Temperature Runs

To show that the peak in the specific heat is the result of insufficient averaging, we have done very long runs at a single temperature ( $T = 0.289855 < T_p$ ) just below the peak temperature. We initiated the run with a configuration of 512 particles generated by parallel tempering at  $T = 0.289855$ , equilibrated for 50 million time steps, and then ran for an additional 100 million time steps during which we recorded the energy at every time step. Then we did block averaging in which we divided our 100 million time steps into equal segments, each of length  $\Delta t_b$ , and calculated the specific heat from energy fluctuations for each segment. Then we averaged the specific heat over the segments of the same length.

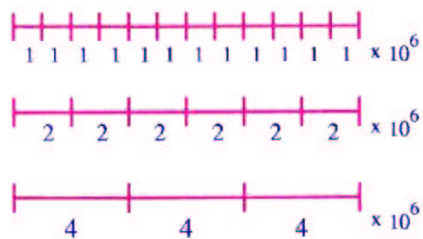

### Specific Heat for Different Time Spans

We calculate the specific heat for different time spans at a given temperature.

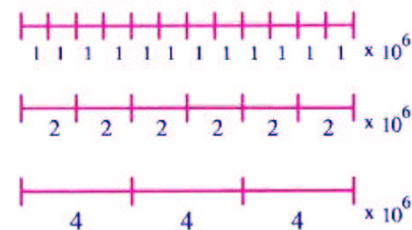

$$C_V = \frac{\langle E^2 \rangle - \langle E \rangle^2}{N k_B T^2} = \frac{\sigma^2}{k_B T^2}$$

We find that the specific heat increases with measuring time span  $\Delta t_b$  at temperatures roughly at or below the temperature of the peak in the specific heat. This increase occurs even for  $\Delta t_b \gg \tau \sim 10^6$ , the "relaxation time."

Specific Heat vs. Time Span for Different Time Spans  
 $T=0.2898551 < T_{peak}$ , 23 runs

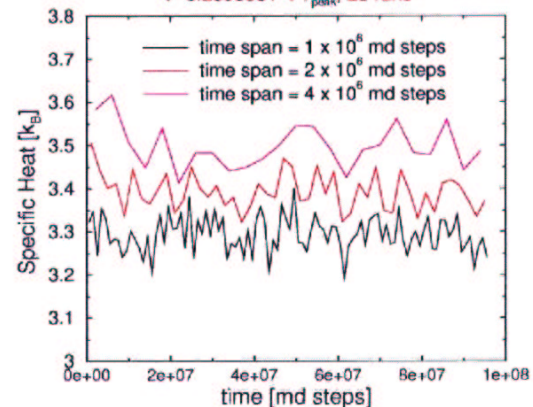

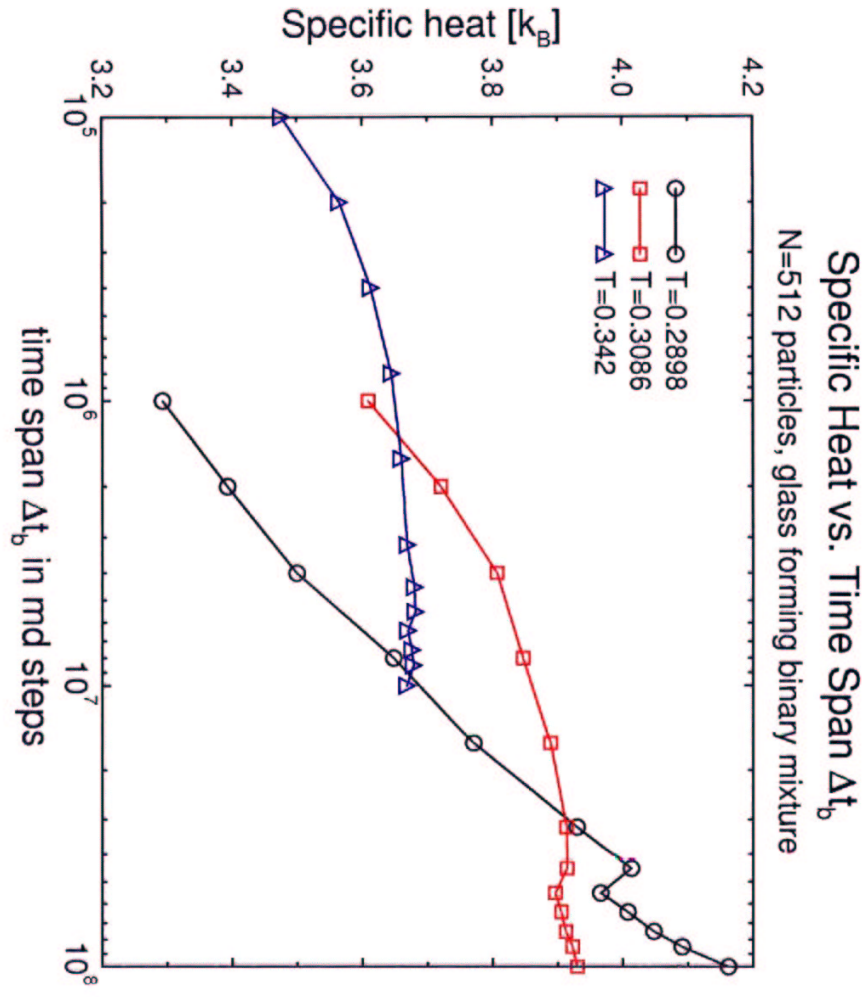
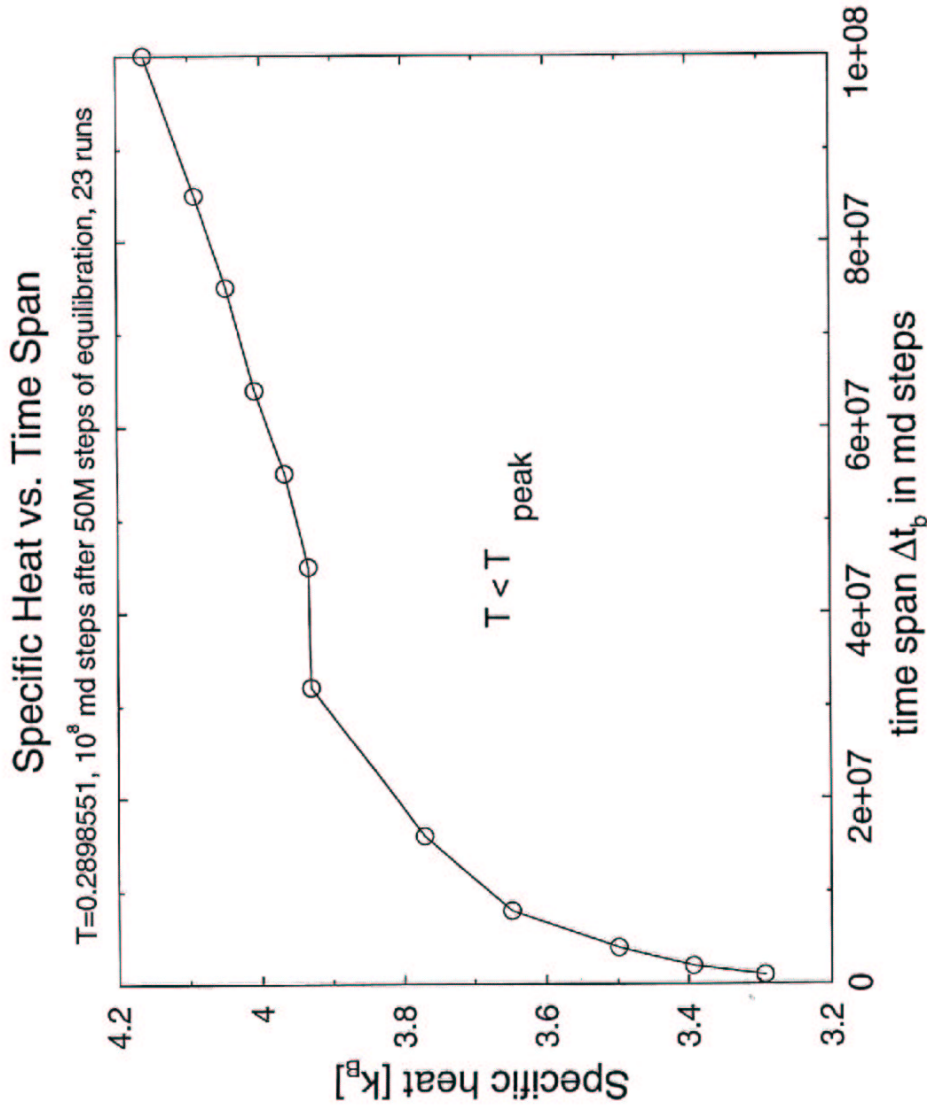

### Specific Heat vs. Time Span $\Delta t_b$

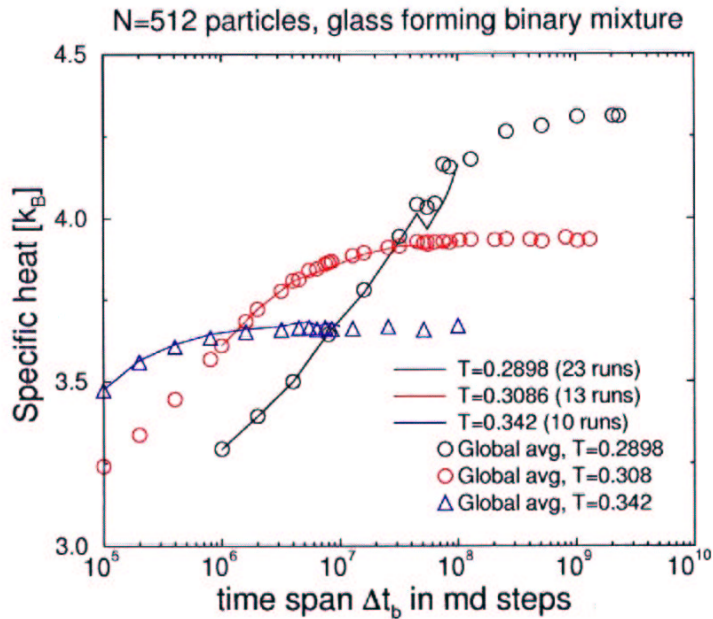

To obtain time spans that are longer than any given run, we concatenated the energies from the runs done at a given temperature to make one huge run, and then did block averaging on the huge run.



We call this **global averaging**.

### Removal of the Specific Heat Peak

We find that a glass forming liquid can undergo a glass transition, as signaled by a peak in the specific heat  $C_V$  vs.  $T$ , that is due to insufficient averaging by a system that is not aging. When enough averaging is done to obtain an accurate thermodynamic estimate of the specific heat, the specific heat peak is removed.

### Specific Heat vs. Temperature

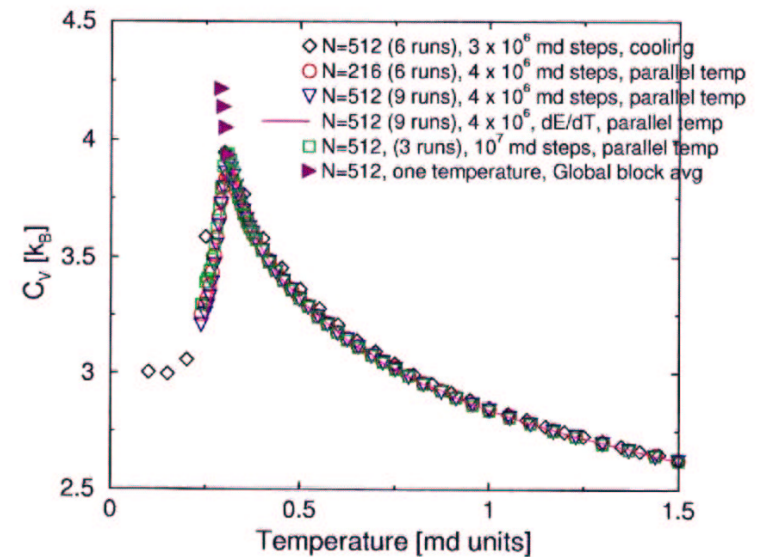

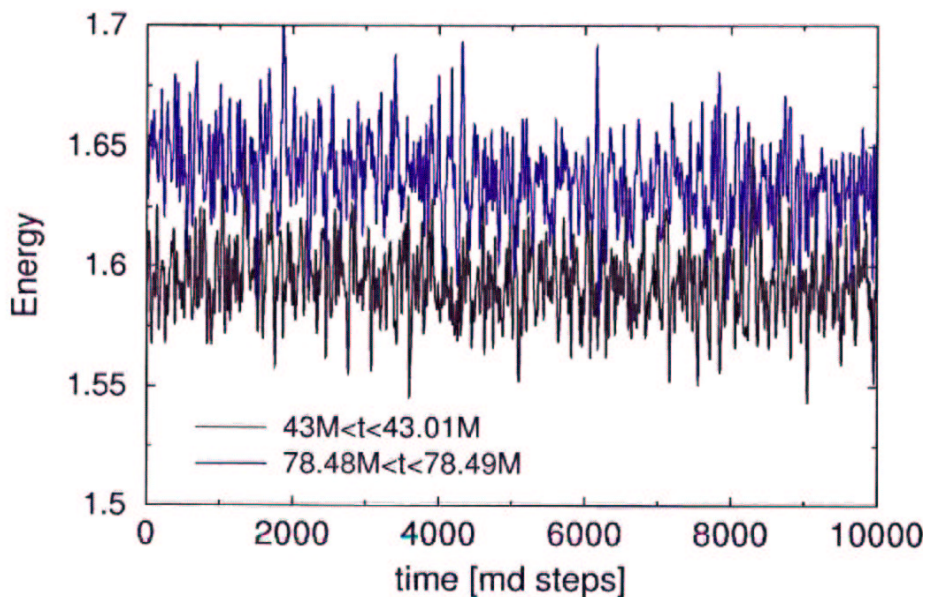
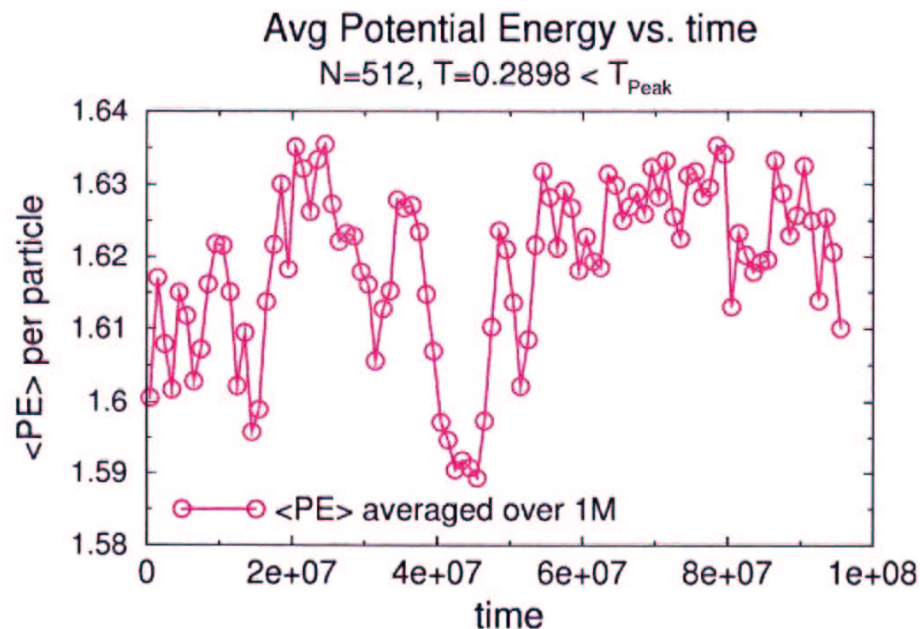

The distribution of energies that a system samples in a basin of the energy landscape is a subset of the full distribution of energies available to the system.

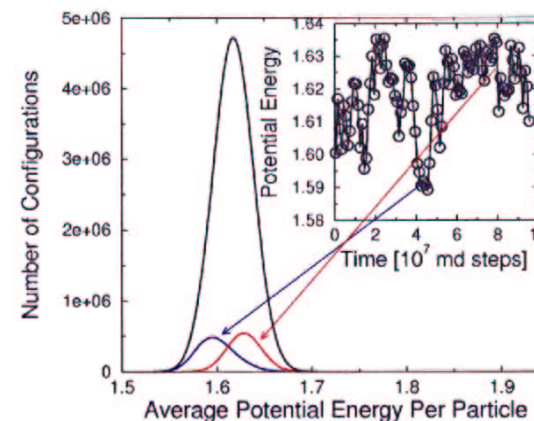

This subset has a smaller variance than the full distribution. The resulting specific heat  $C_V$  is proportional to the variance  $\sigma^2$  of the energy:

$$C_V = \frac{\langle E^2 \rangle - \langle E \rangle^2}{Nk_B T^2} = \frac{\sigma^2}{Nk_B T^2}$$

So  $C_V$  will be smaller when calculated from short time spans than from long time spans. These smaller values account for the values below the peak in  $C_V$  on the low temperature side. Going to longer time spans eliminates the peak, though at temperatures below the peak temperature  $T_p$ , these longer time spans can be orders of magnitude longer than previously recognized equilibration times such as the  $\alpha$  relaxation time, the energy correlation time, and the aging time.

Specific Heat vs. Temperature

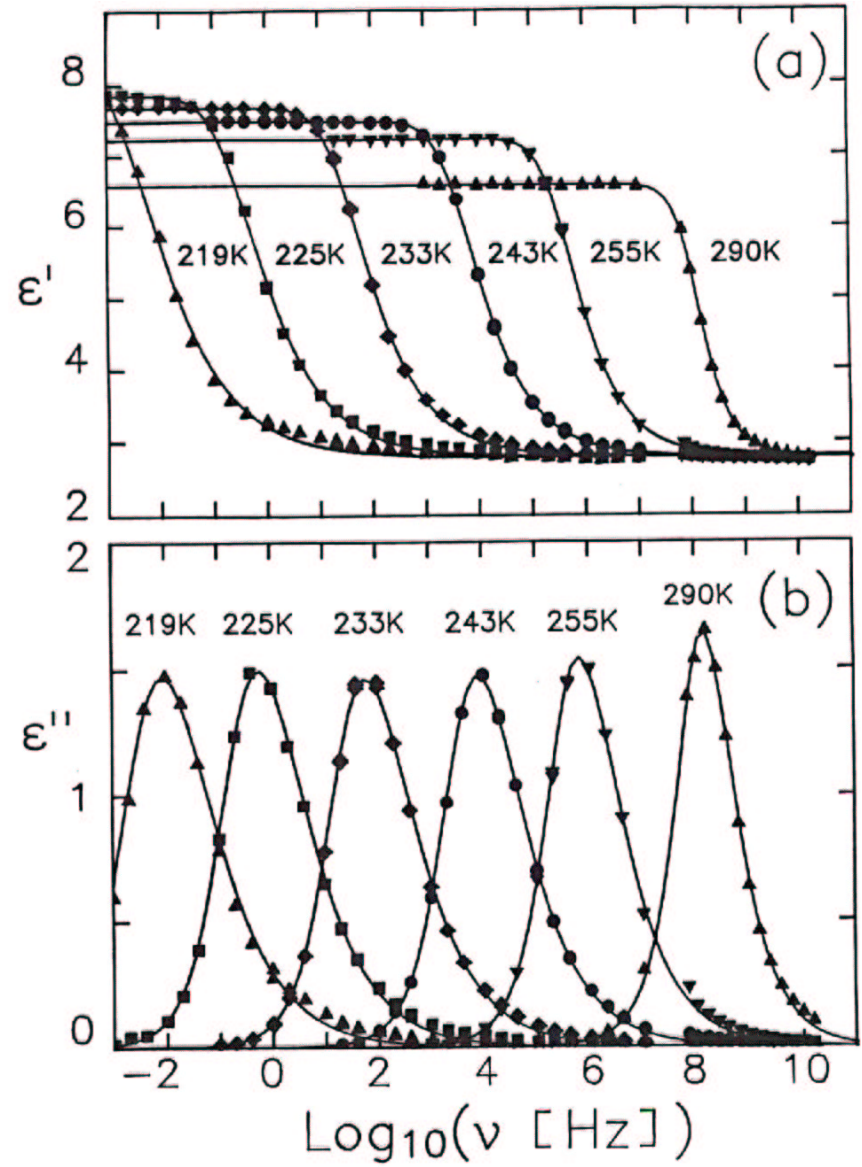
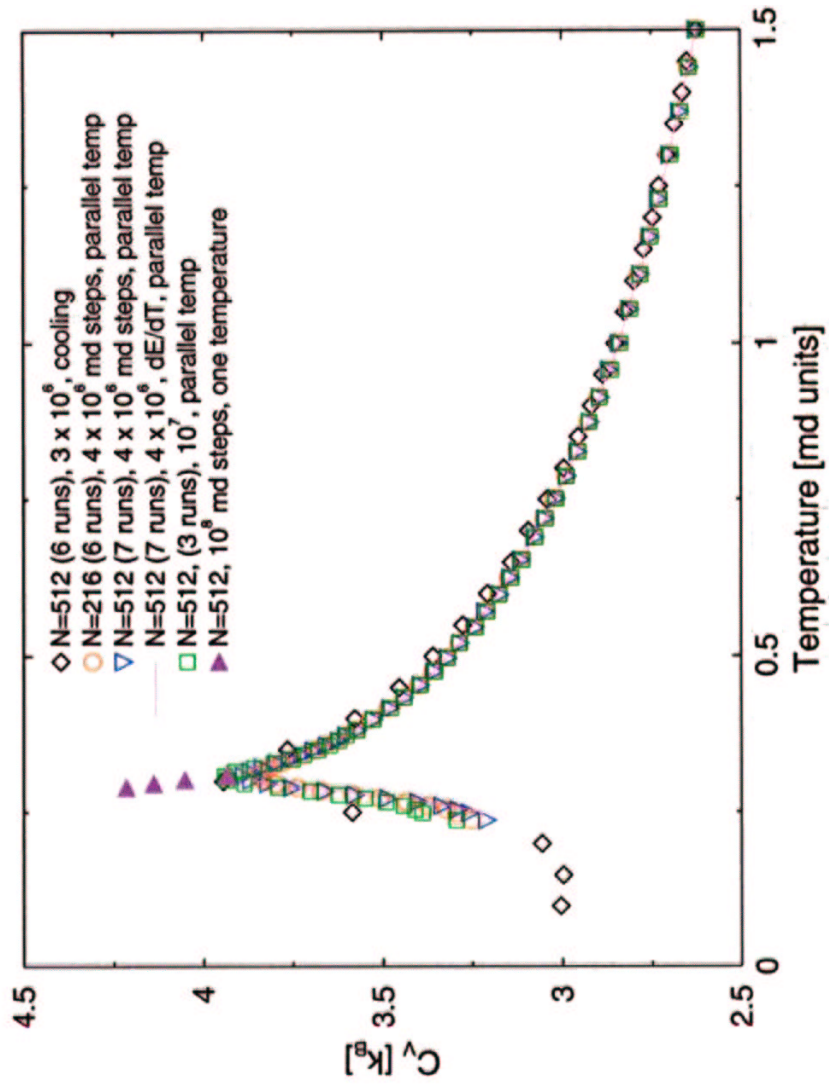

Salol

Dixon et al.

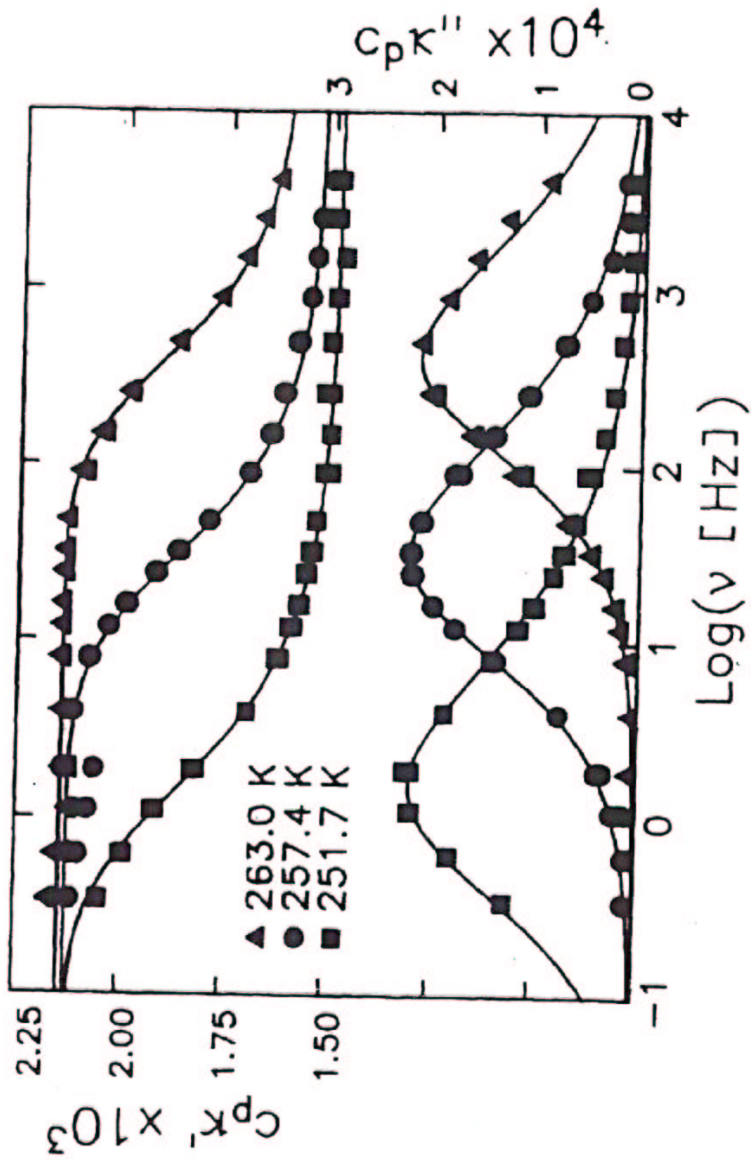

*(o-terphenyl)<sub>1-x</sub>(o-phenylphenol)<sub>x</sub>*

Dixon et al.

### Frequency Dependent Specific Heat

The increase of the specific heat with time span is mirrored in the frequency dependence of the specific heat. The frequency dependent specific heat is given by

$$C_V(\omega) = \frac{3Nk_B}{2} + \phi_V(t=0) - \omega \int_0^\infty \phi_V(t) \sin(\omega t) dt$$

where the energy autocorrelation function

$$\phi_V(t) = \frac{\langle (E(t) - \langle E \rangle)(E(0) - \langle E \rangle) \rangle_{t_0}}{Nk_B T^2}$$

$E$  is the potential energy of the system and  $\langle \dots \rangle_{t_0}$  indicates an average over initial times.

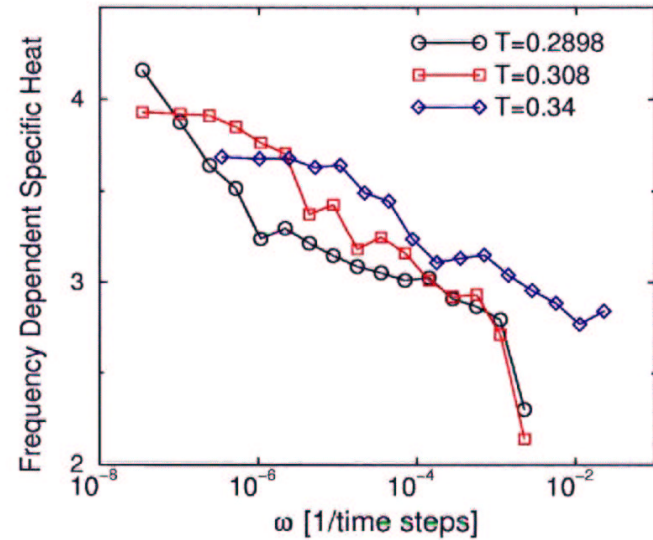



### Frequency Dependent Specific Heat

In the frequency dependent specific heat, the period is like the time span.

- Lower frequency  $\Rightarrow$  Longer period
- $\Rightarrow$  more energies sampled
- $\Rightarrow$  larger energy variance
- $\Rightarrow$  larger specific heat

This is why the increase of the specific heat with time span is mirrored in the frequency dependence of the specific heat in a system which is not aging and is in equilibrium.

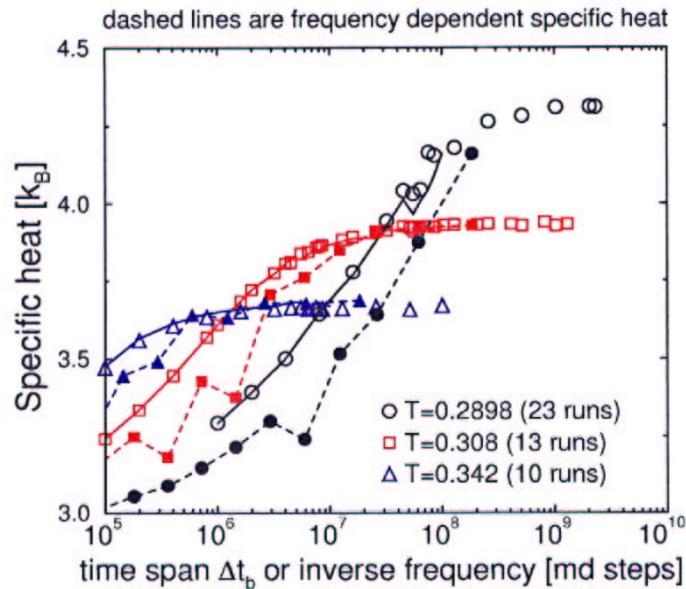

### No Aging in Specific Heat for a Given Time Span

We calculate the specific heat for different time spans at a given temperature.

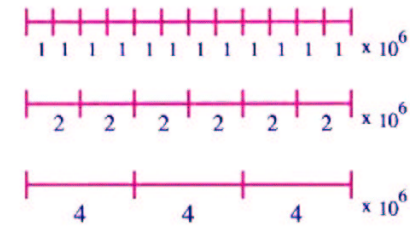

For a given time span  $\Delta t_b$ , the specific heat shows no signs of aging.

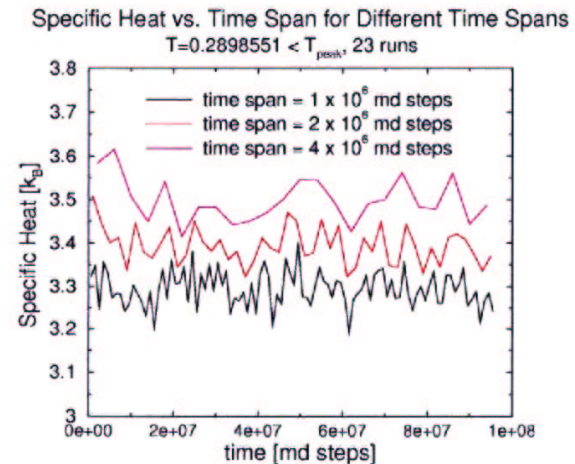

### No Aging for $t > \tau$

Recall that we use the intermediate scattering function  $F(k, t)$  to find the  $\alpha$  relaxation time  $\tau$ .  $\tau$  is defined by  $F(k, \tau) = 1/e$ .  $\tau$  is a measure of the time it takes for a configuration to lose its memory of a previous configuration. To look for aging we have varied the waiting time  $t_w$ , i.e., the time we run the simulation before we start calculating  $F(k, t)$ . We see no signs of aging for  $t > \tau$ . So  $\tau$  is the aging time. At  $T = 0.289855$ ,  $\tau \approx 10^6$  time steps.

$$F(\vec{k}, t) = \frac{1}{N} \langle \rho_{\vec{k}}(t) \rho_{-\vec{k}}(0) \rangle$$

Full Intermediate Scattering Function vs. Time

N= 512 particles, T=0.289855

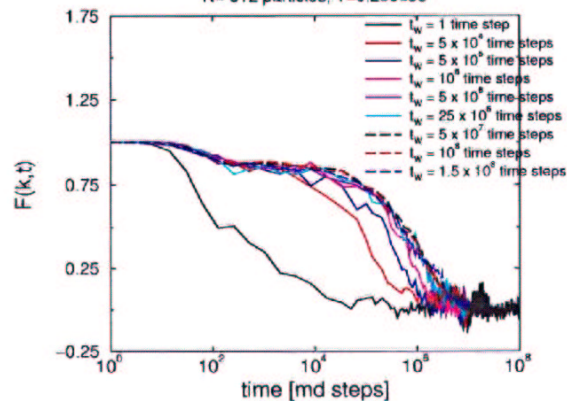

### Inherent Structure Energy vs. Time

There is no evidence of aging in the inherent structure energy versus time in our runs of 100 million time steps at  $T = 0.289855 < T_C$ , though noise in the data prevents us from seeing changes smaller than 1%.

Inherent Structure Energy vs. Time

$10^6$  md steps, T=0.2898551, 40 runs

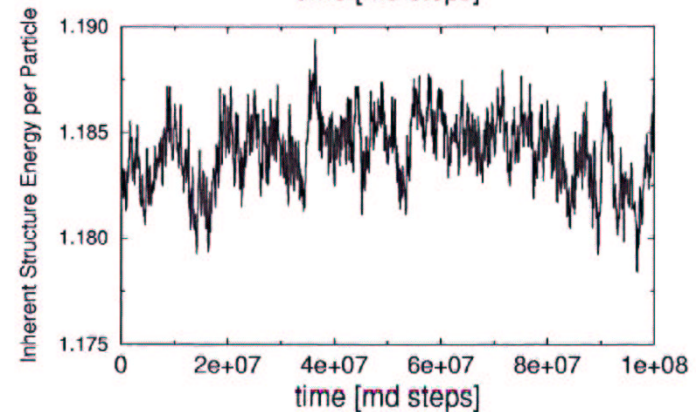
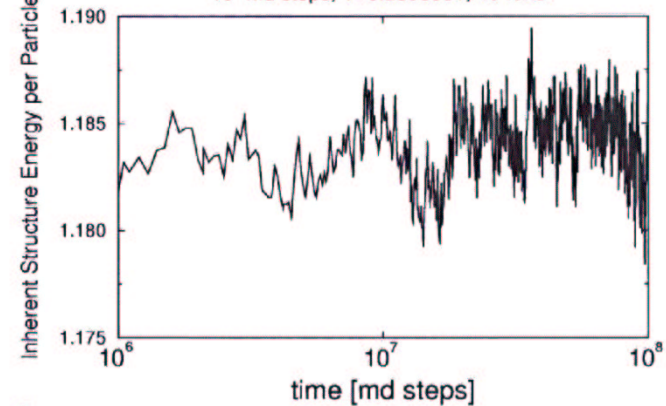

### Conclusions

We have performed a molecular dynamics simulation on a glass forming liquid consisting of a two component mixture of soft spheres in three dimensions. We have shown that a glass transition, signaled by a peak in the specific heat vs. temperature, can occur because a glassy system that shows no signs of aging progresses so slowly through the energy landscape that the sampling time needed to obtain an accurate estimate of the thermodynamic averages exceeds the observation time. Below the observed glass transition temperature this sampling time can be orders of magnitude longer than previously recognized equilibration times such as the  $\alpha$  relaxation time and the aging time. This long equilibration time results in a specific heat that has frequency dependence down to very low frequencies.

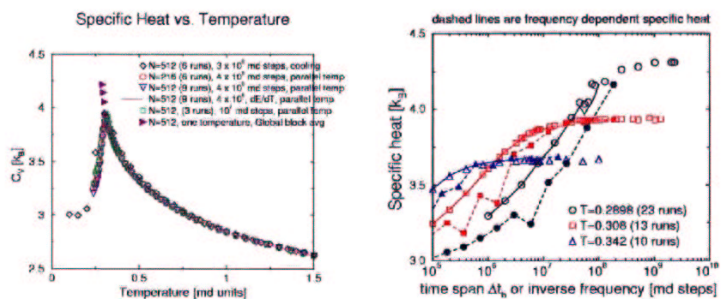

Specific Heat vs. Temperature for a Crystal  
1 run,  $10^6$  md steps, Parallel tempering, N=216

