



Strongly interacting cold atoms

No $\backslash \text{cl} \text{N} [] \text{b}^{\wedge} _ \text{p}$

Talks online at <http://sachdev.physics.harvard.edu>



Outline

Strongly interacting cold atoms

1. Quantum liquids near unitarity:
from few-body to many-body physics
 - (a) Tonks gas in one dimension
 - (b) Paired fermions across a Feshbach resonance

2. Optical lattices
 - (a) Superfluid-insulator transition
 - (b) Quantum-critical hydrodynamics via mapping to quantum theory of black holes.
 - (c) Entanglement of valence bonds

Outline

Strongly interacting cold atoms

1. Quantum liquids near unitarity:
from few-body to many-body physics
 - (a) Tonks gas in one dimension
 - (b) Paired fermions across a Feshbach resonance

2. Optical lattices
 - (a) Superfluid-insulator transition
 - (b) Quantum-critical hydrodynamics via mapping to quantum theory of black holes.
 - (c) Entanglement of valence bonds

Fermions with repulsive interactions

$$H = \sum_k (\varepsilon_k - \mu) c_{k\sigma}^\dagger c_{k\sigma}$$

+ short-range repulsive interactions of strength u

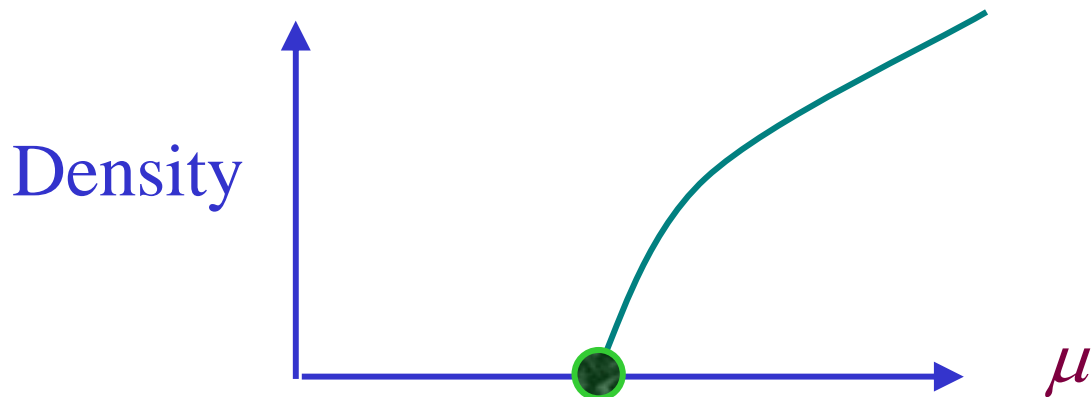
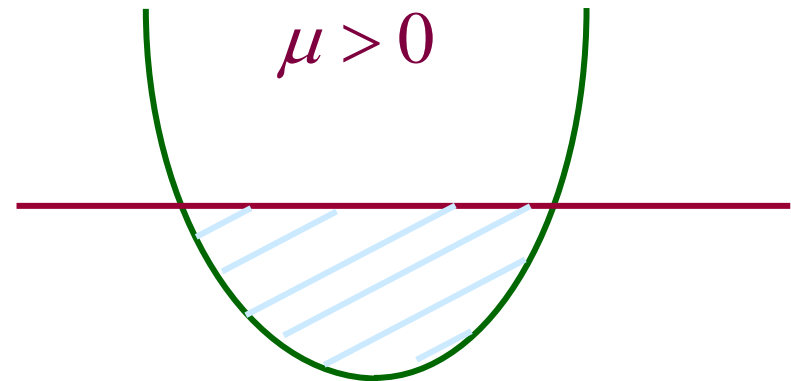
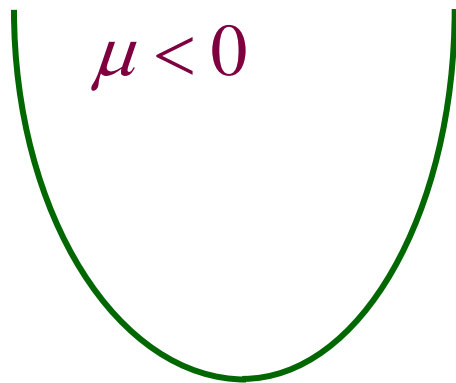

Fermions with repulsive interactions

Characteristics of this ‘trivial’ quantum critical point:

- Zero density critical point allows an elegant connection between few body and many body physics.
- No “order parameter”. “Topological” characterization in the existence of the Fermi surface in one state.
- No transition at $T > 0$.
- Characteristic crossovers at $T > 0$, between quantum criticality, and low T regimes.

Fermions with repulsive interactions

Characteristics of this 'trivial' quantum critical point:

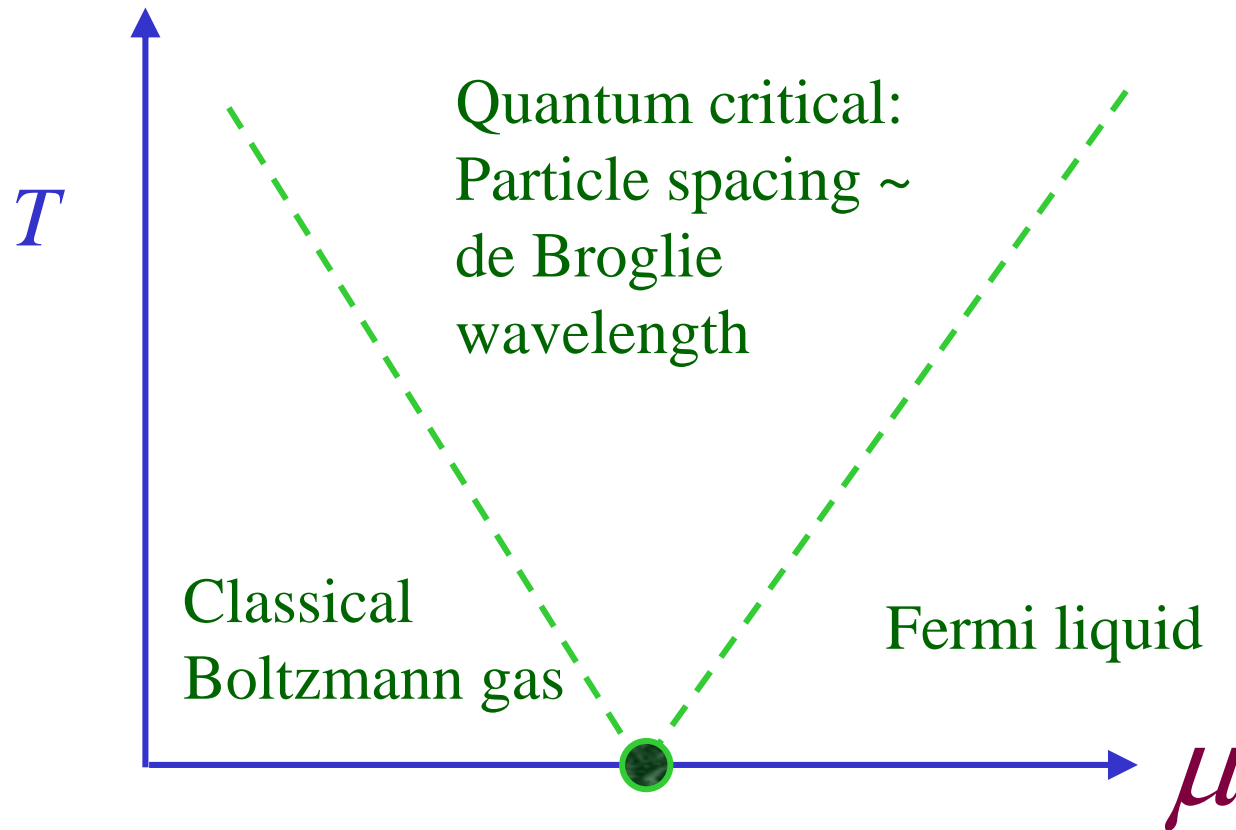

Fermions with repulsive interactions

Characteristics of this ‘trivial’ quantum critical point:

RG flow characterizing quantum critical point:

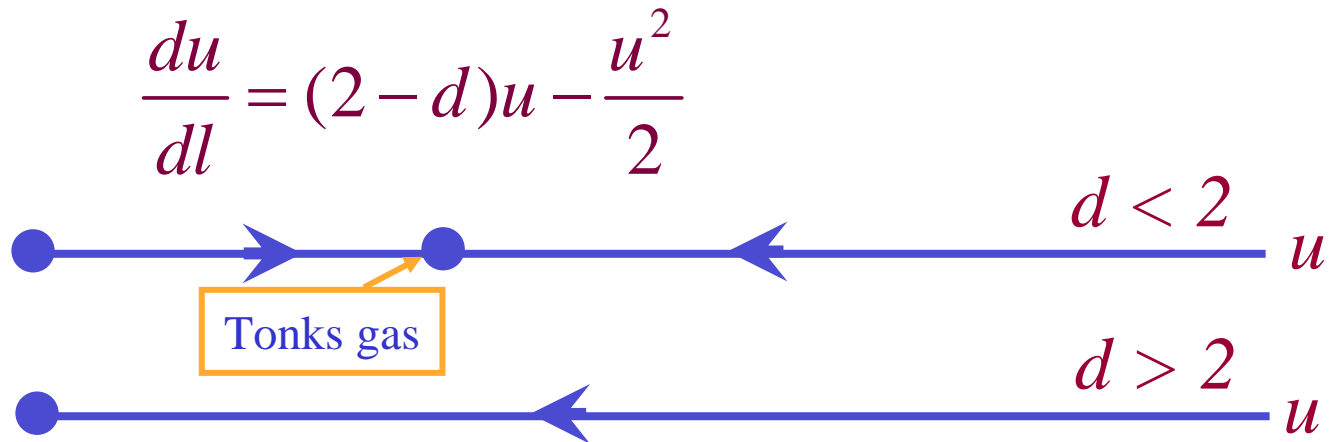

- $d > 2$ – interactions are irrelevant. Critical theory is the *spinful* free Fermi gas.
- $d < 2$ – universal fixed point interactions. In $d=1$ critical theory is the *spinless* free Fermi gas (Tonks gas).

Bosons with repulsive interactions

$$\frac{du}{dl} = (2-d)u - \frac{u^2}{2}$$

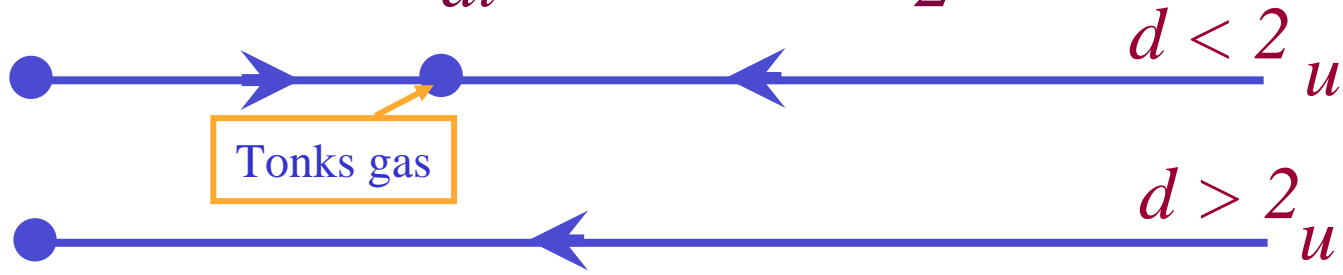

- Critical theory in $d = 1$ is also the *spinless free Fermi gas* (Tonks gas).
- The dilute Bose gas in $d > 2$ is controlled by the zero-coupling fixed point. Interactions are “dangerously irrelevant” and the density above onset depends upon bare interaction strength (Yang-Lee theory).

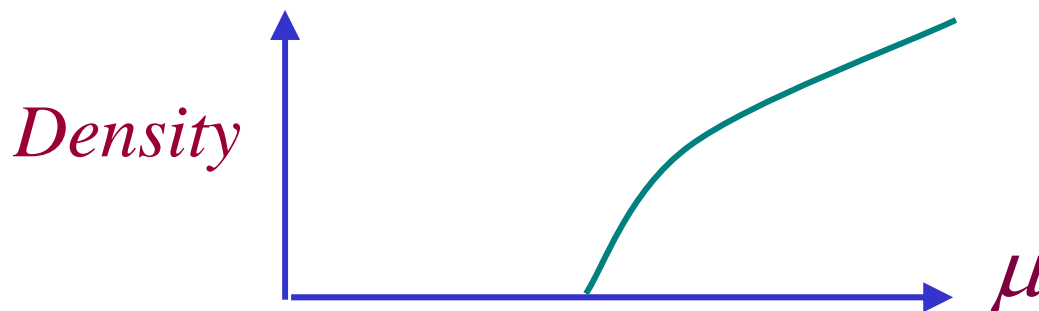

Fermions with attractive interactions

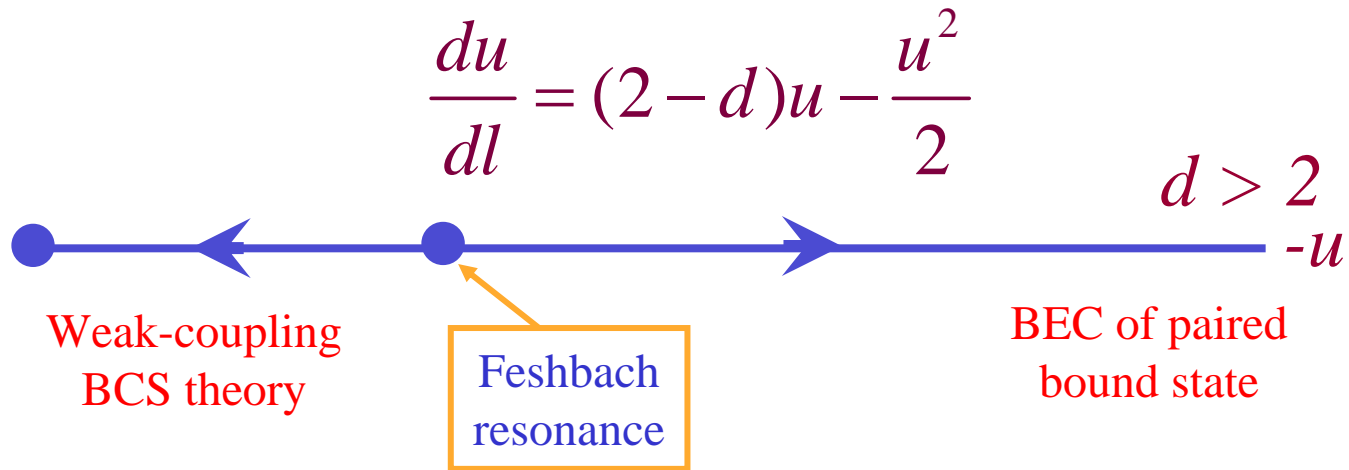

- Universal fixed-point is accessed by *fine-tuning* to a Feshbach resonance.
- Density onset transition is described by free fermions for weak-coupling, and by (nearly) free bosons for strong coupling. The quantum-critical point between these behaviors is the Feshbach resonance.

Fermions with attractive interactions

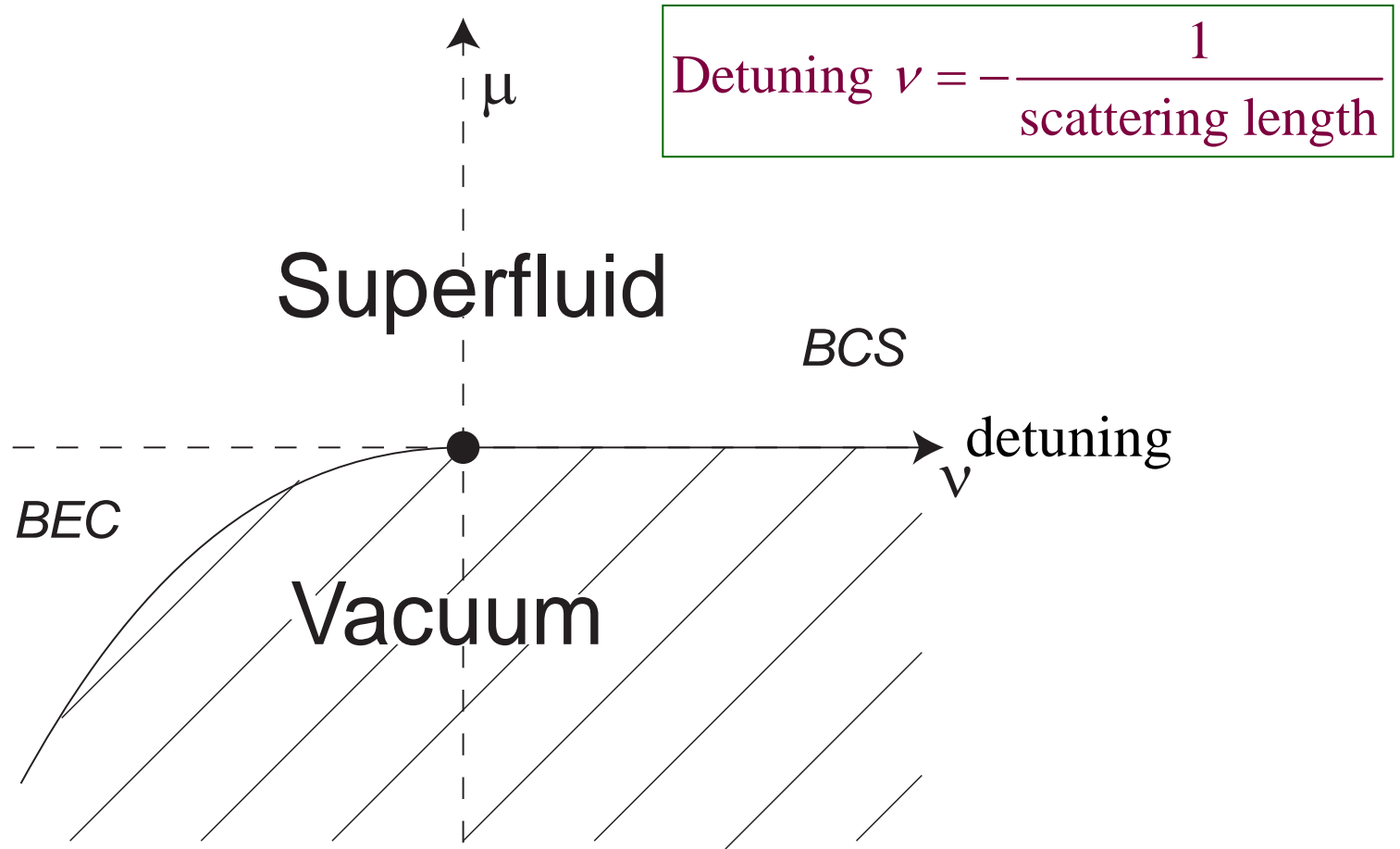

Fermions with attractive interactions

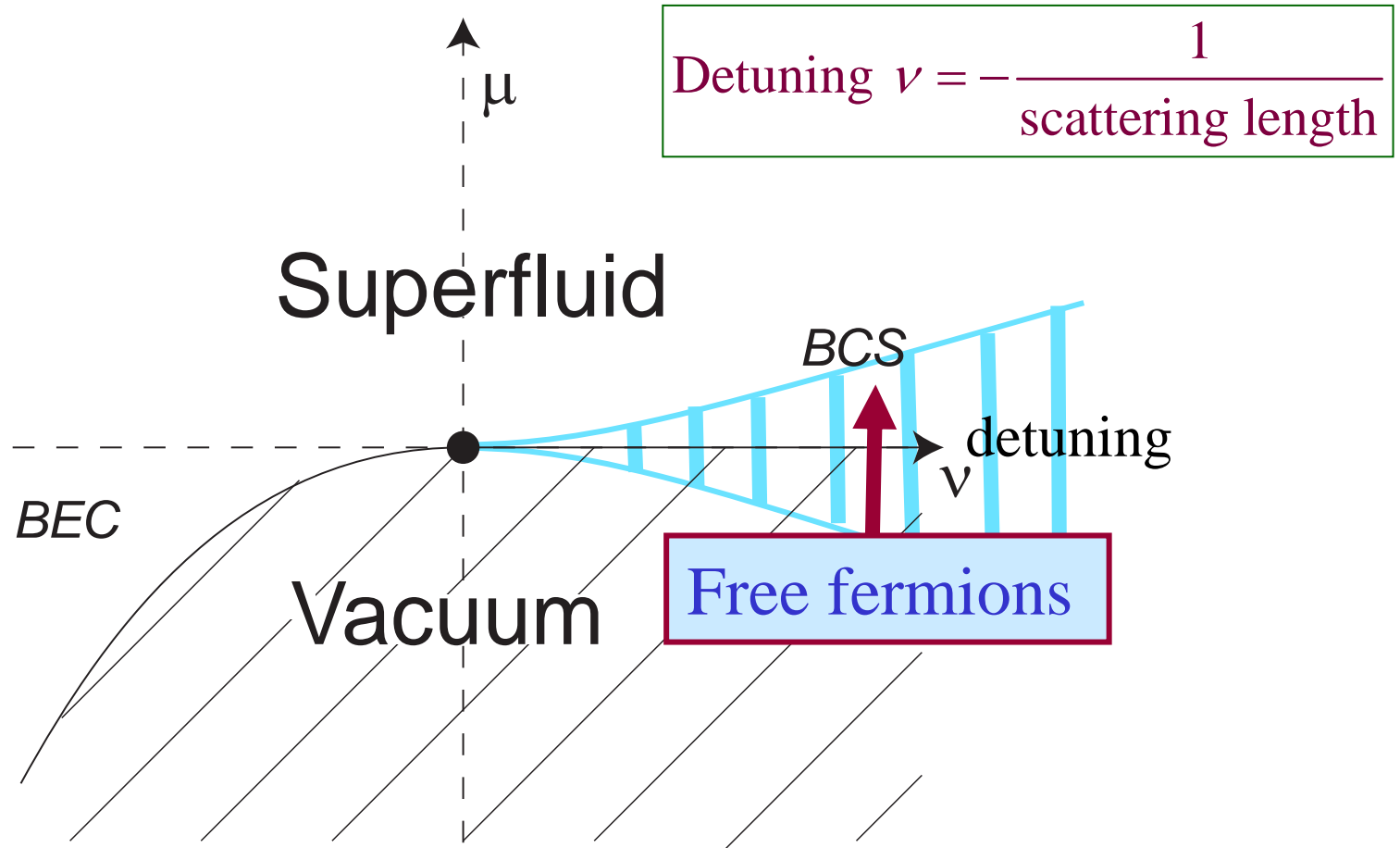

Fermions with attractive interactions

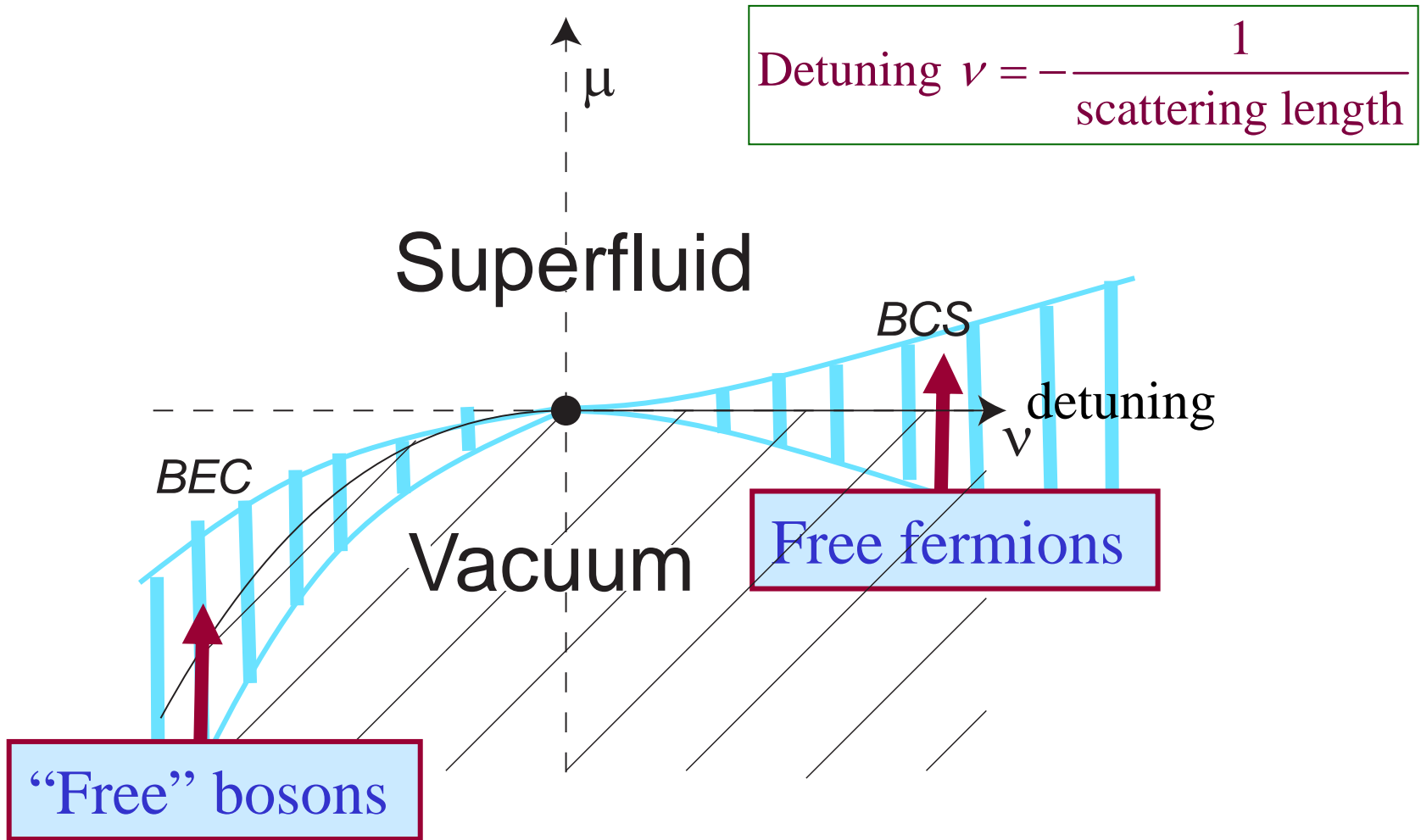

Fermions with attractive interactions

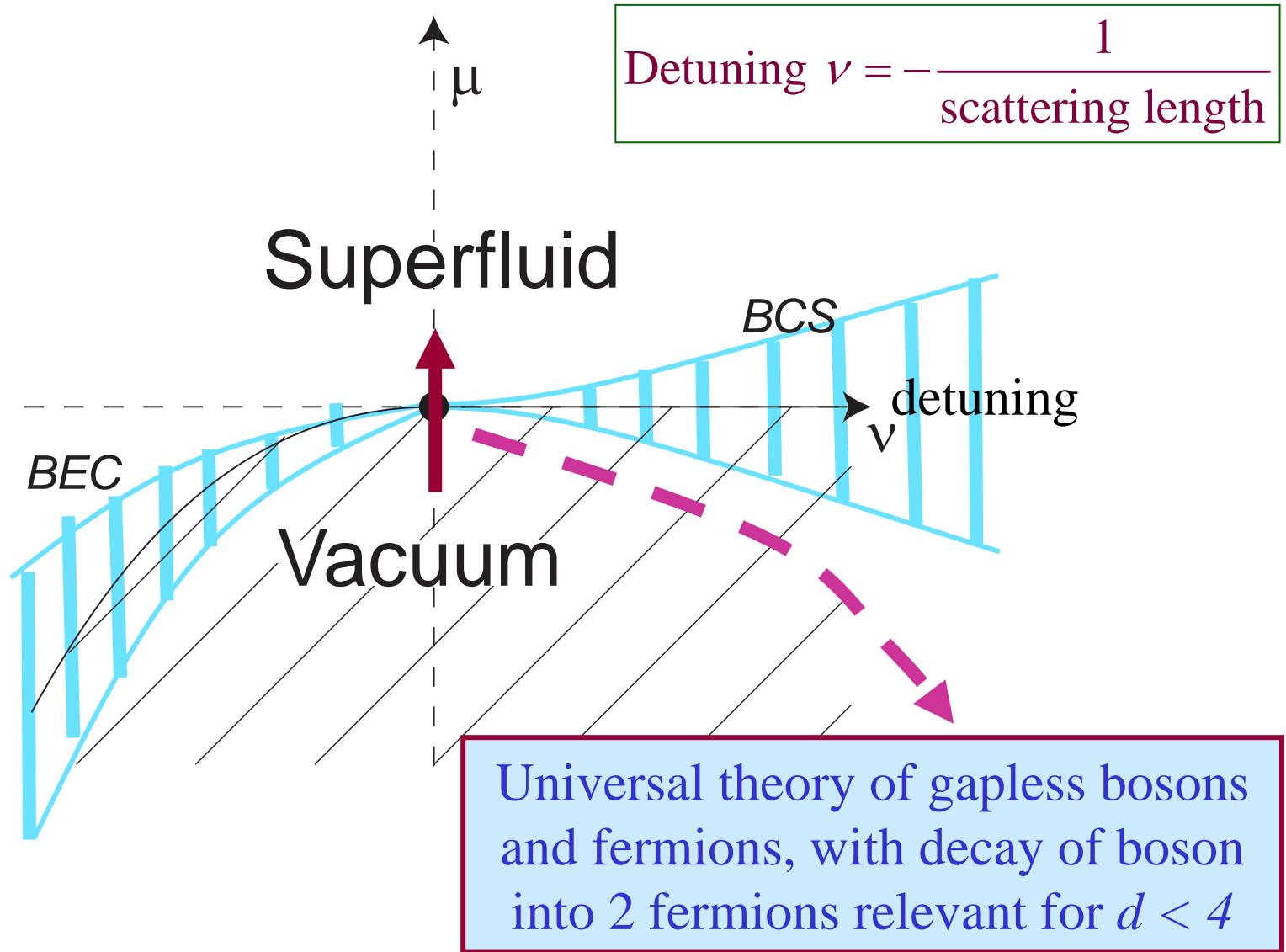

Fermions with attractive interactions

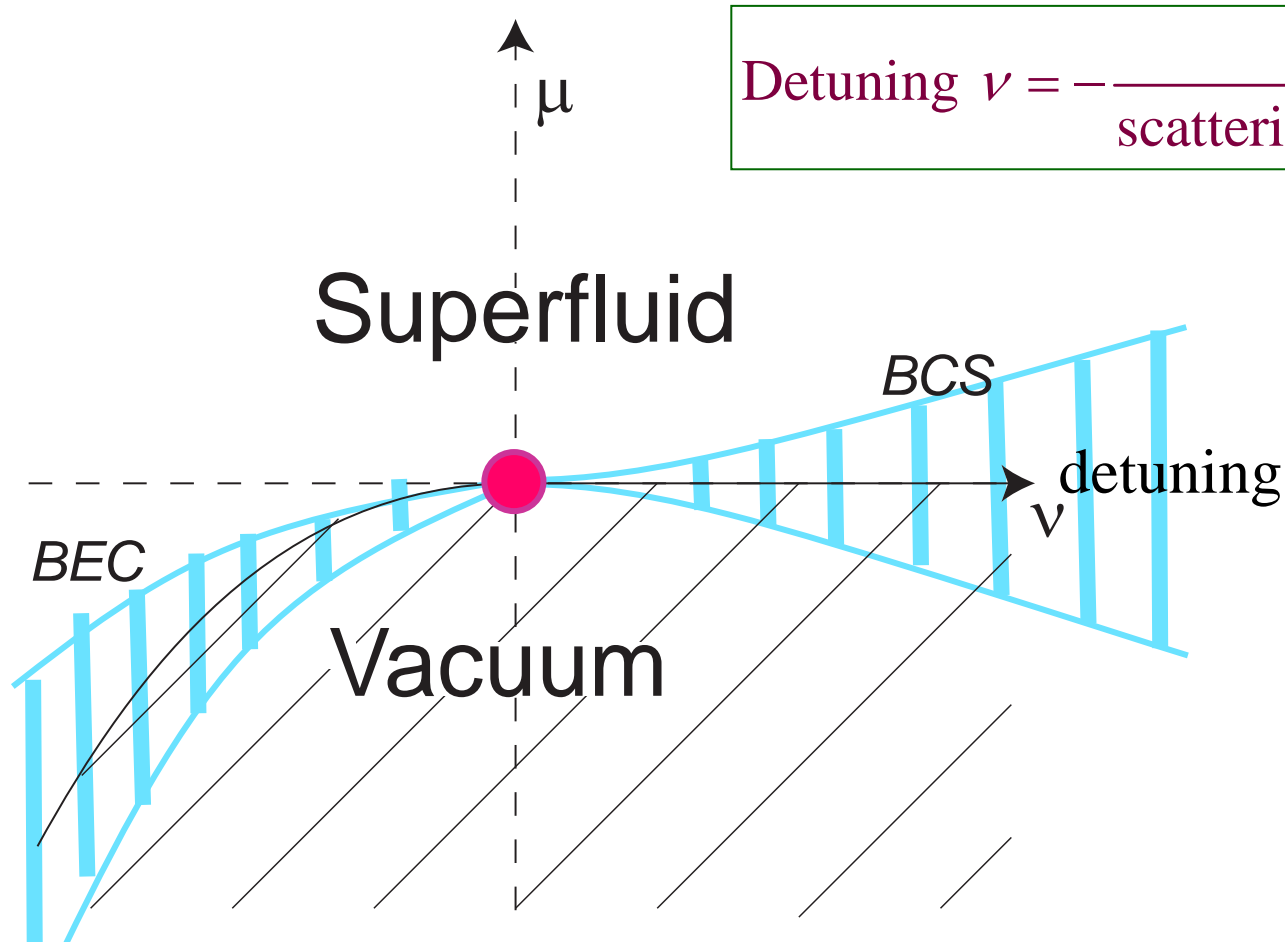

Quantum critical point at $\mu=0, \nu=0$, forms the basis of the theory of the BEC-BCS crossover, including the transitions to FFLO and normal states with unbalanced densities

Fermions with attractive interactions

Universal phase diagram

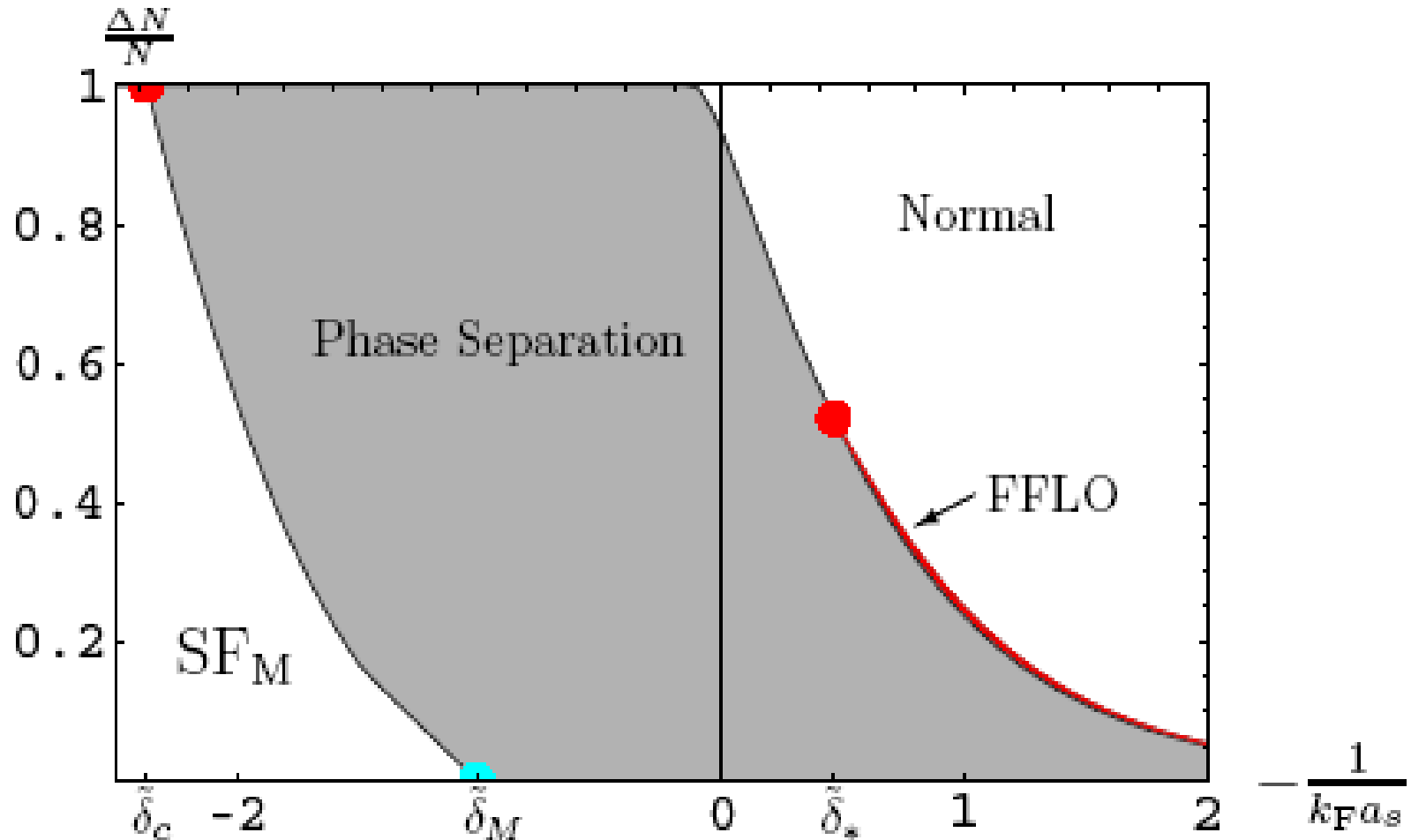

D. E. Sheehy and L. Radzihovsky, *Phys. Rev. Lett.* **95**, 130401 (2005)

Fermions with attractive interactions

Universal phase diagram

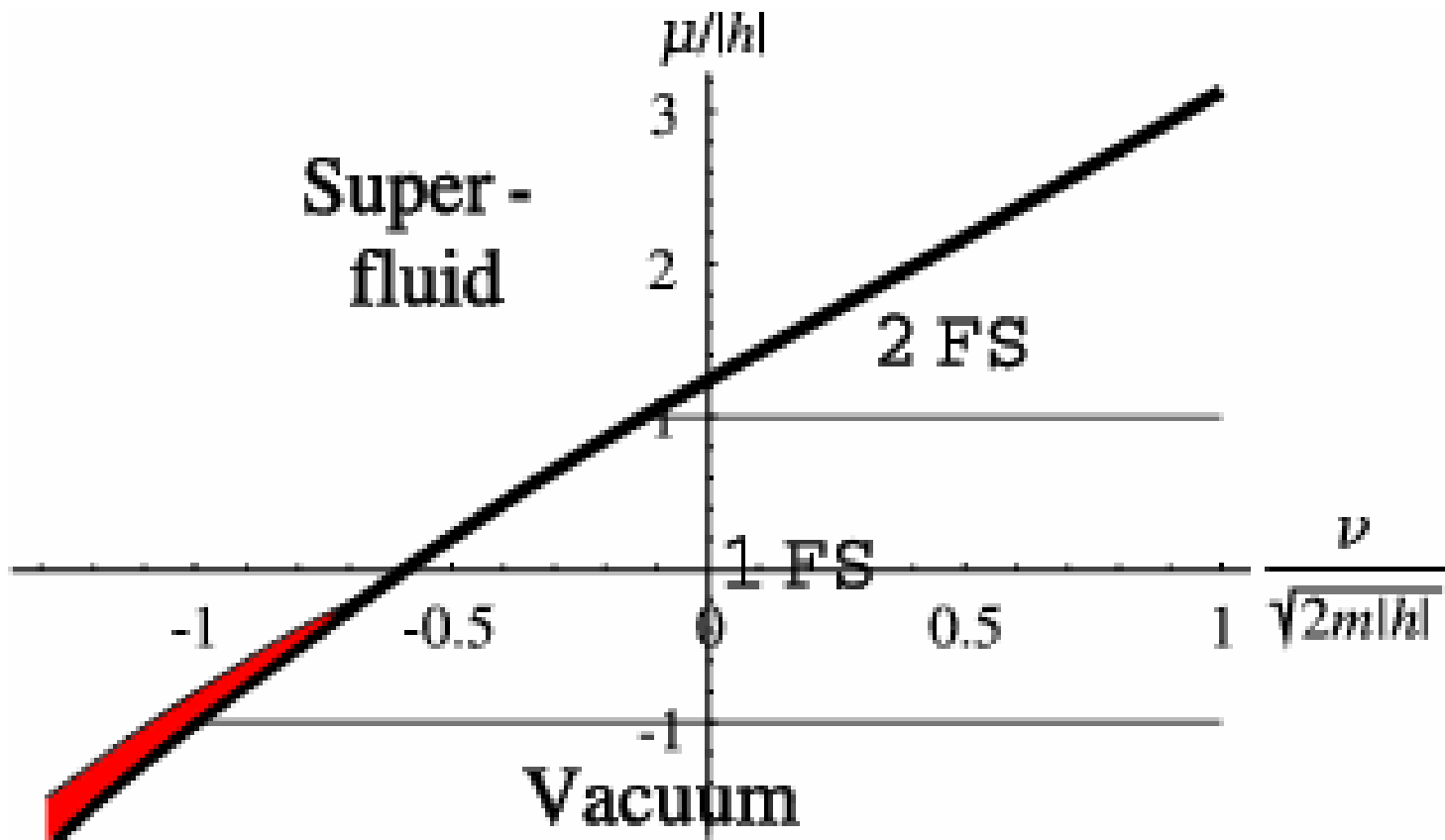

h – Zeeman field

Fermions with attractive interactions

Universal phase diagram

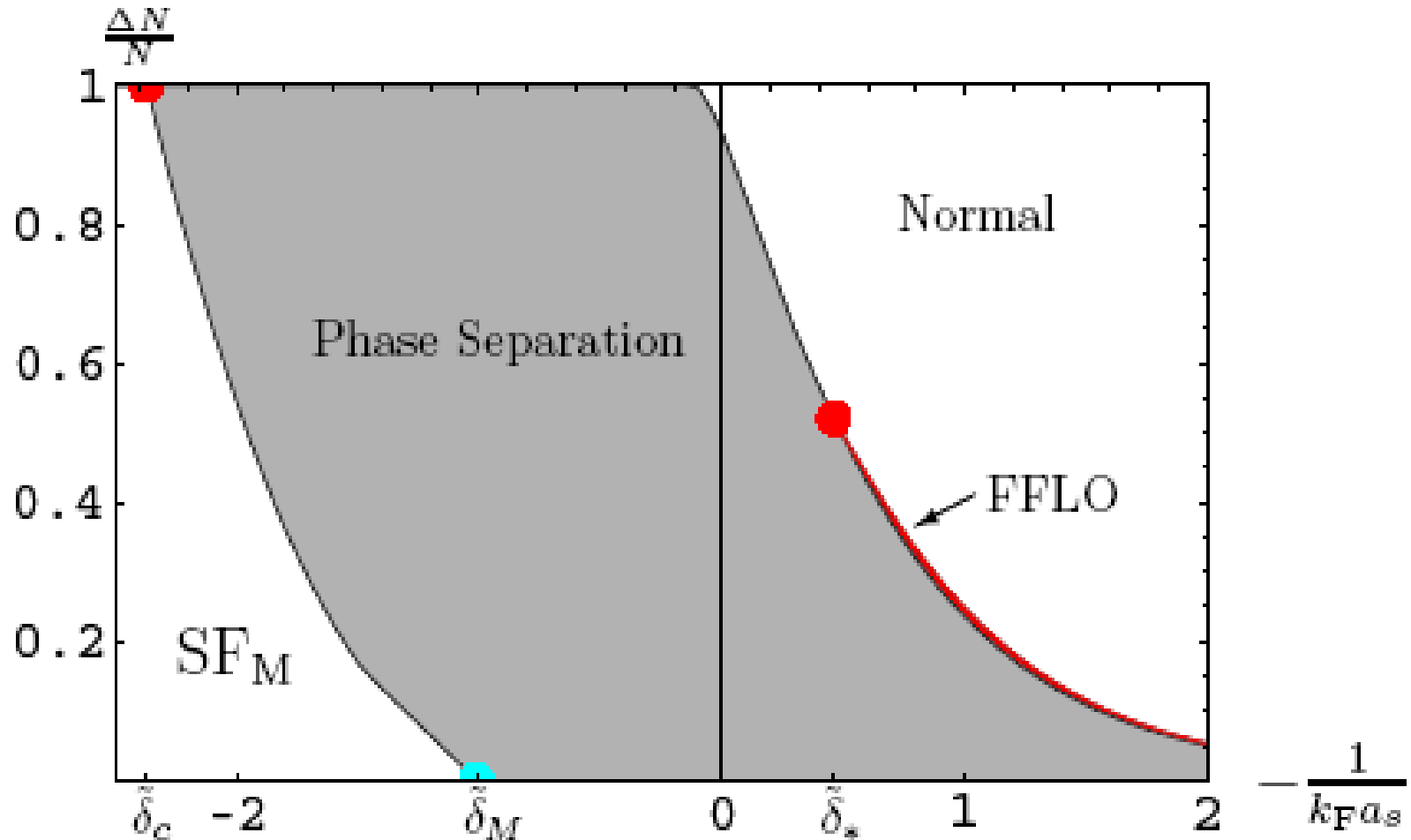

D. E. Sheehy and L. Radzihovsky, *Phys. Rev. Lett.* **95**, 130401 (2005)

Fermions with attractive interactions

Universal phase diagram

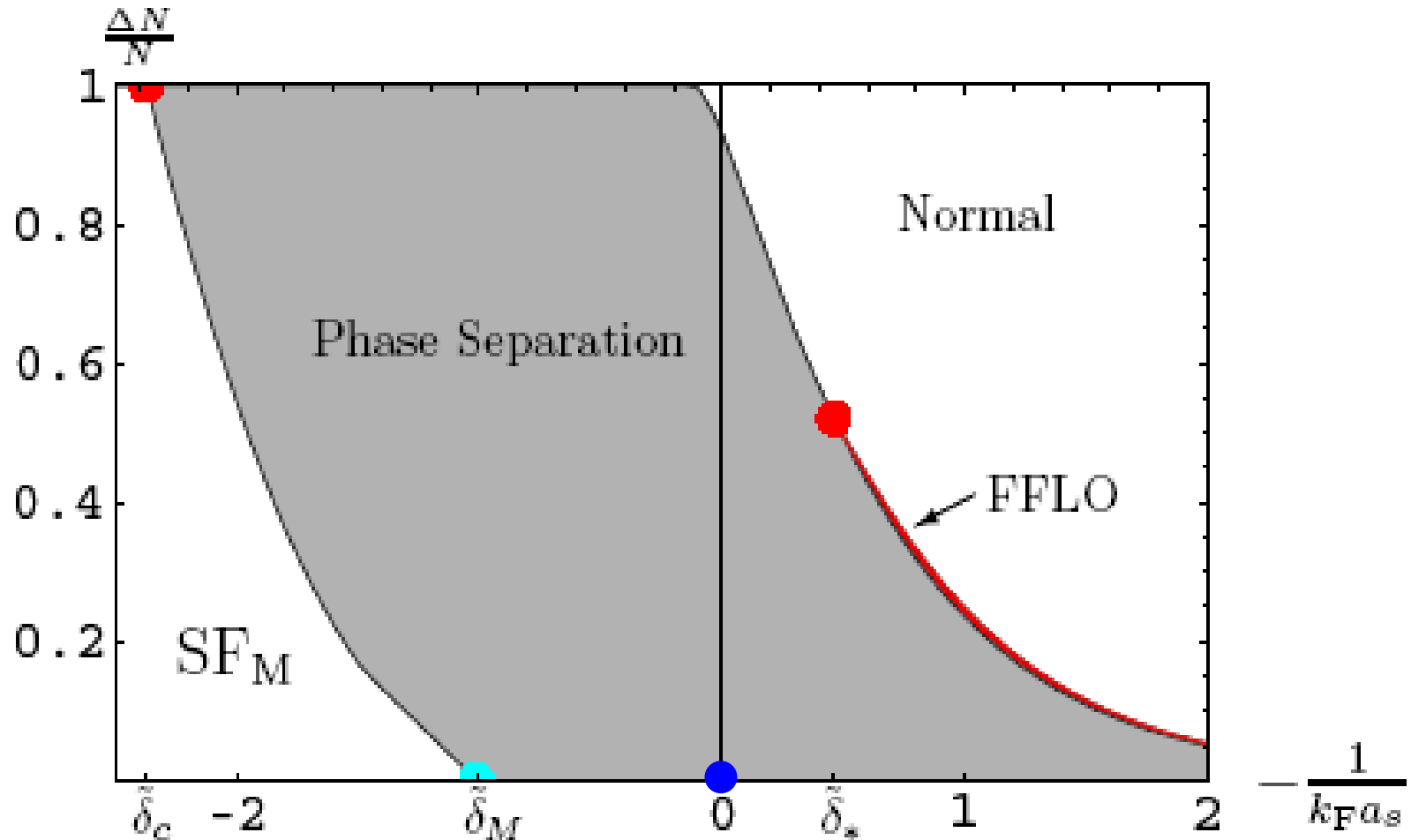

D. E. Sheehy and L. Radzihovsky, *Phys. Rev. Lett.* **95**, 130401 (2005)

Fermions with attractive interactions

Ground state properties at unitarity and balanced density

$$\frac{\Delta}{\varepsilon_F} = \sqrt{\varepsilon} + \frac{\varepsilon^{3/2}}{8} \ln(\varepsilon) - 0.3947 \varepsilon^{3/2}$$

Expansion in $\varepsilon=4$ -d

Y. Nishida and D.T. Son,

Phys. Rev. Lett. **97**, 050403 (2006)

$$\frac{\mu}{\varepsilon_F} = \frac{\varepsilon^{3/2}}{2} + \frac{\varepsilon^{5/2}}{16} \ln(\varepsilon) - 0.0246 \varepsilon^{5/2}$$

$$\frac{\Delta}{\varepsilon_F} = 0.6864 - \frac{0.163}{N}$$

Expansion in $1/N$ with $\text{Sp}(2N)$ symmetry

M. Y. Veillette, D. E. Sheehy, and L. Radzihovsky

Phys. Rev. A **75**, 043614 (2007)

$$\frac{\mu}{\varepsilon_F} = 0.5906 - \frac{0.312}{N}$$

$$\frac{\Delta}{\varepsilon_F} = 0.54$$

Quantum Monte Carlo

J. Carlon, S.-Y. Chang, V.R. Pandharipande, and

K.E. Schmidt, *Phys. Rev. Lett.* **91**, 050401 (2003).

$$\frac{\mu}{\varepsilon_F} = 0.44$$

Fermions with attractive interactions

Ground state properties near unitarity and balanced density

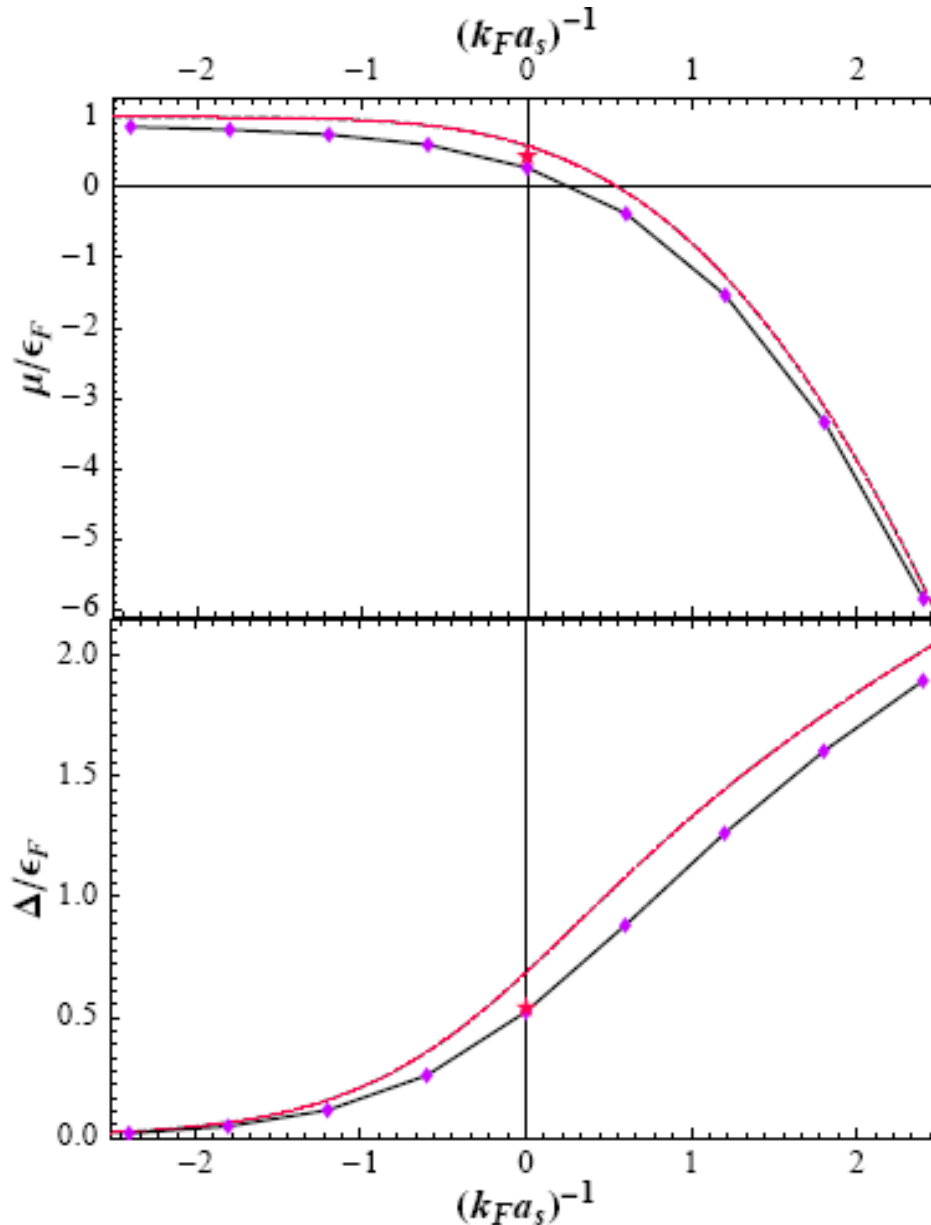

Expansion in $1/N$
with $Sp(2N)$
symmetry
M. Y. Veillette,
D. E. Sheehy, and
L. Radzihovsky
Phys. Rev. A **75**, 043614
(2007)

Quantum Monte
Carlo
J. Carlon, S.-Y. Chang,
V.R. Pandharipande, and
K.E. Schmidt, *Phys. Rev.
Lett.* **91**, 050401 (2003).

Fermions with attractive interactions

Finite temperature properties at unitarity and balanced density

$$\frac{\varepsilon_F}{T_c} = 2.104 + \frac{5.317}{N}$$

$$\frac{\mu}{T_c} = 1.504 + \frac{2.785}{N}$$

$$\frac{P/N}{(2m)^{3/2} T_c^{5/2}} = 0.132 + \frac{0.405}{N}$$

Expansion in $1/N$ with $\text{Sp}(2N)$ symmetry

M. Y. Veillette, D. E. Sheehy, and L. Radzihovsky

Phys. Rev. A **75**, 043614 (2007)

P. Nikolic and S. Sachdev,

Phys. Rev. A **75**, 033608 (2007).

$$\frac{\varepsilon_F}{T_c} = 6.579$$

$$\frac{\mu}{T_c} = 3.247$$

$$\frac{P/N}{(2m)^{3/2} T_c^{5/2}} = 0.776$$

E. Burovski, N. Prokof'ev, B. Svistunov, and
M. Troyer, *New J. Phys.* **8**, 153 (2006)

Fermions with attractive interactions in p-wave channel

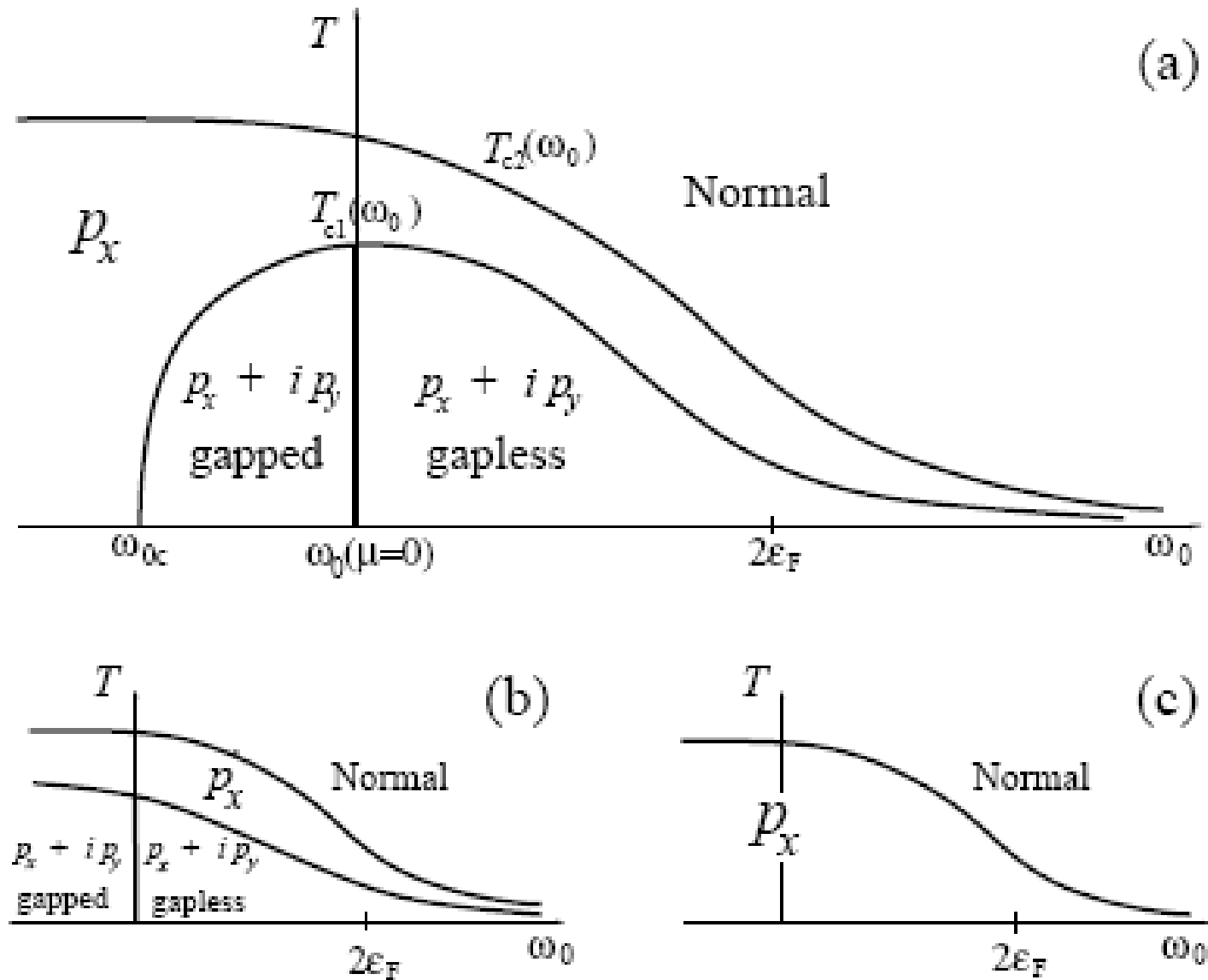

V. Gurarie, L. Radzihovsky, and A.V. Andreev, *Phys. Rev. Lett.* **94**, 230403 (2005)

C.-H. Cheng and S.-K. Yip, *Phys. Rev. Lett.* **95**, 070404 (2005)

Outline

Strongly interacting cold atoms

1. Quantum liquids near unitarity:
from few-body to many-body physics
 - (a) Tonks gas in one dimension
 - (b) Paired fermions across a Feshbach resonance

2. Optical lattices
 - (a) Superfluid-insulator transition
 - (b) Quantum-critical hydrodynamics via mapping to quantum theory of black holes.
 - (c) Entanglement of valence bonds

Outline

Strongly interacting cold atoms

1. Quantum liquids near unitarity:
from few-body to many-body physics
 - (a) Tonks gas in one dimension
 - (b) Paired fermions across a Feshbach resonance

2. Optical lattices
 - (a) Superfluid-insulator transition
 - (b) Quantum-critical hydrodynamics via mapping to quantum theory of black holes.
 - (c) Entanglement of valence bonds

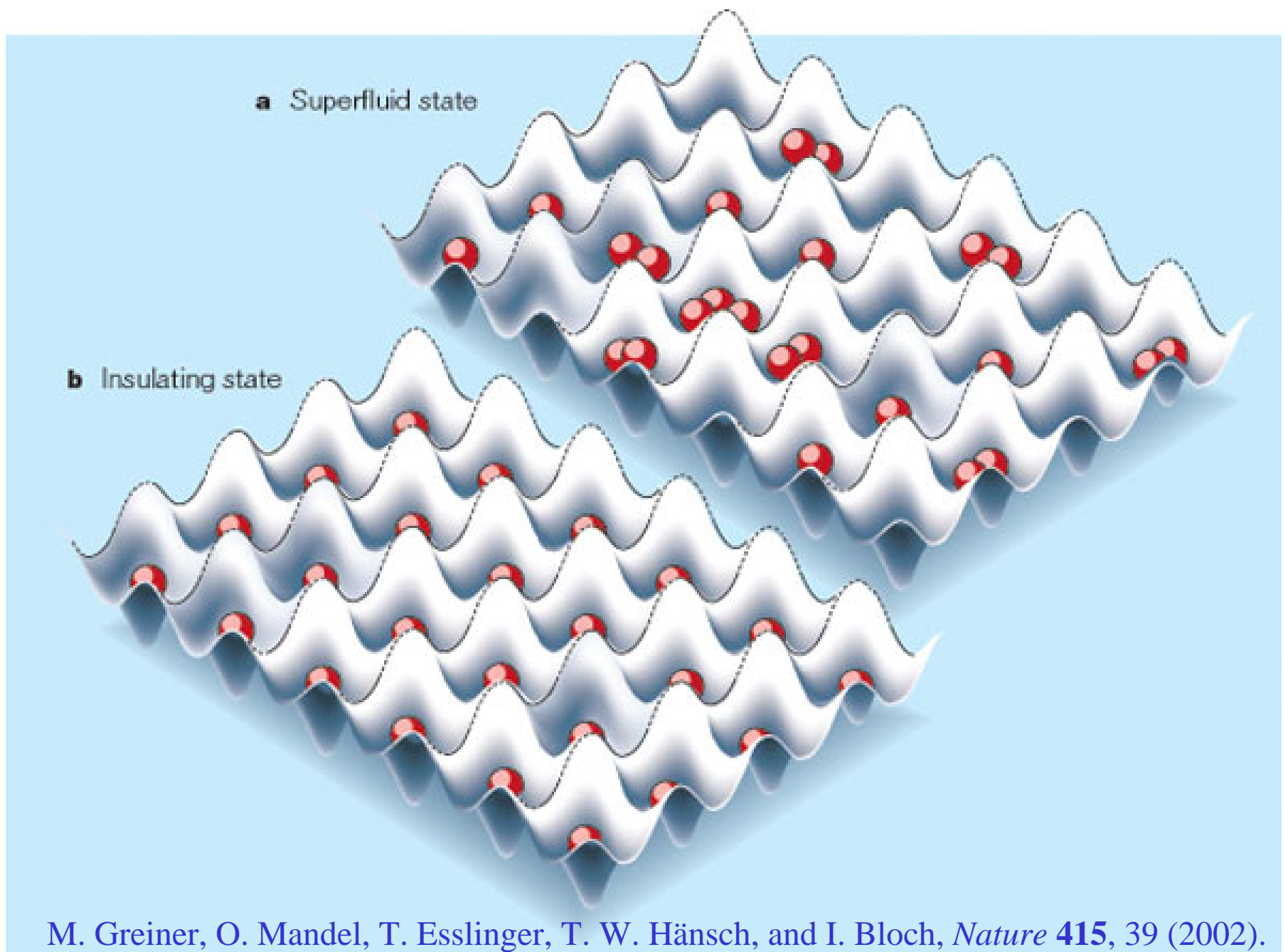

Velocity distribution of ^{87}Rb atoms

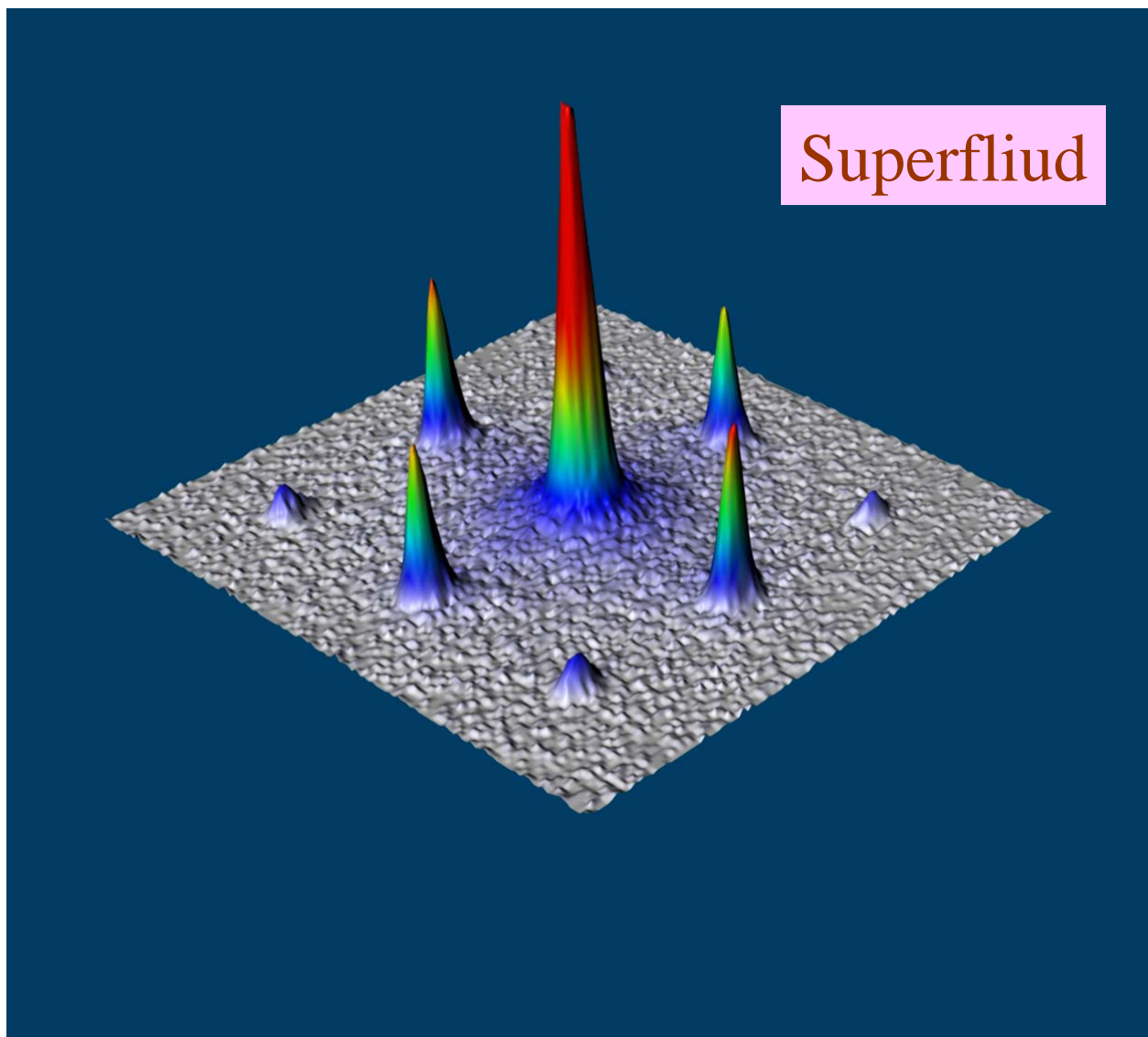

Velocity distribution of ^{87}Rb atoms

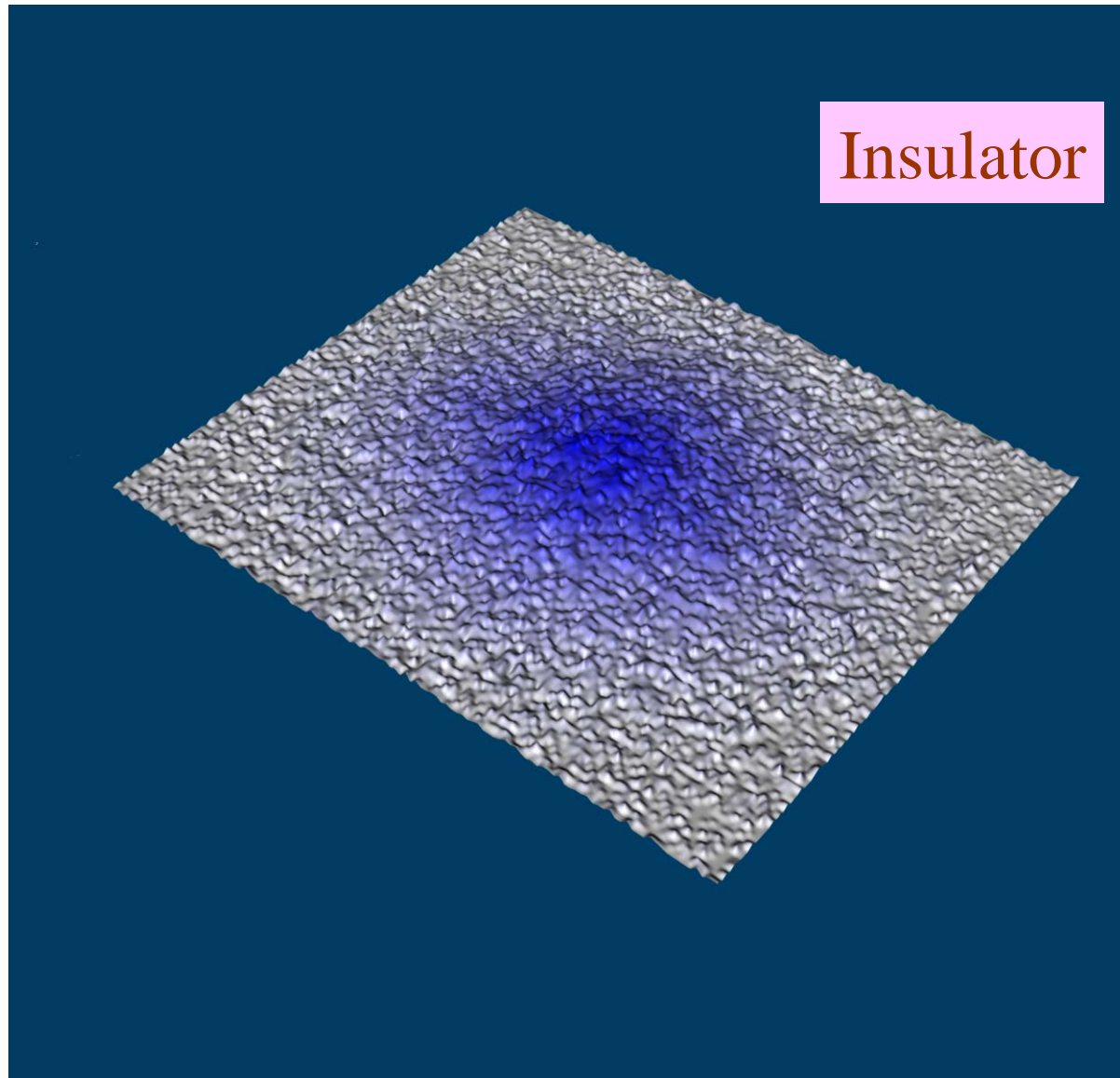

Noise correlation (time of flight) in Mott-insulators

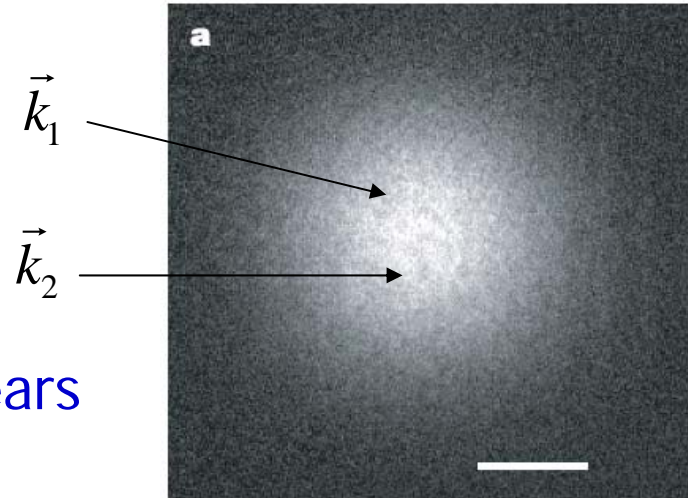
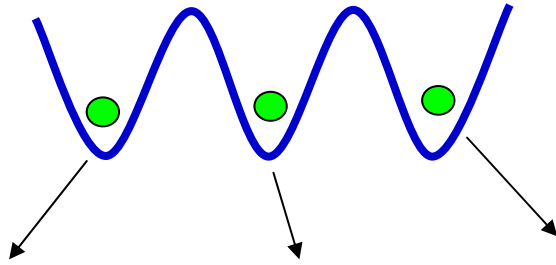

- 1st order coherence $\langle n(\vec{k}) \rangle$ disappears in the Mott-insulating state.

- Noise correlation function oscillates at reciprocal lattice vectors; bunching effect of bosons.

$$\langle n(\vec{k}_1)n(\vec{k}_2) \rangle - \langle n(\vec{k}_1) \rangle \langle n(\vec{k}_2) \rangle \propto \sum_{\vec{G}} \delta(\vec{k}_1 - \vec{k}_2 - \vec{G})$$

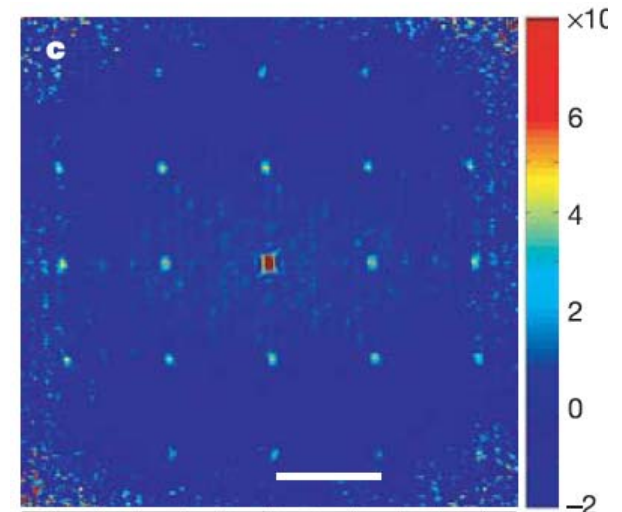

Folling et al., Nature 434, 481 (2005); Altman et al., PRA 70, 13603 (2004).

Two dimensional superfluid-Mott insulator transition

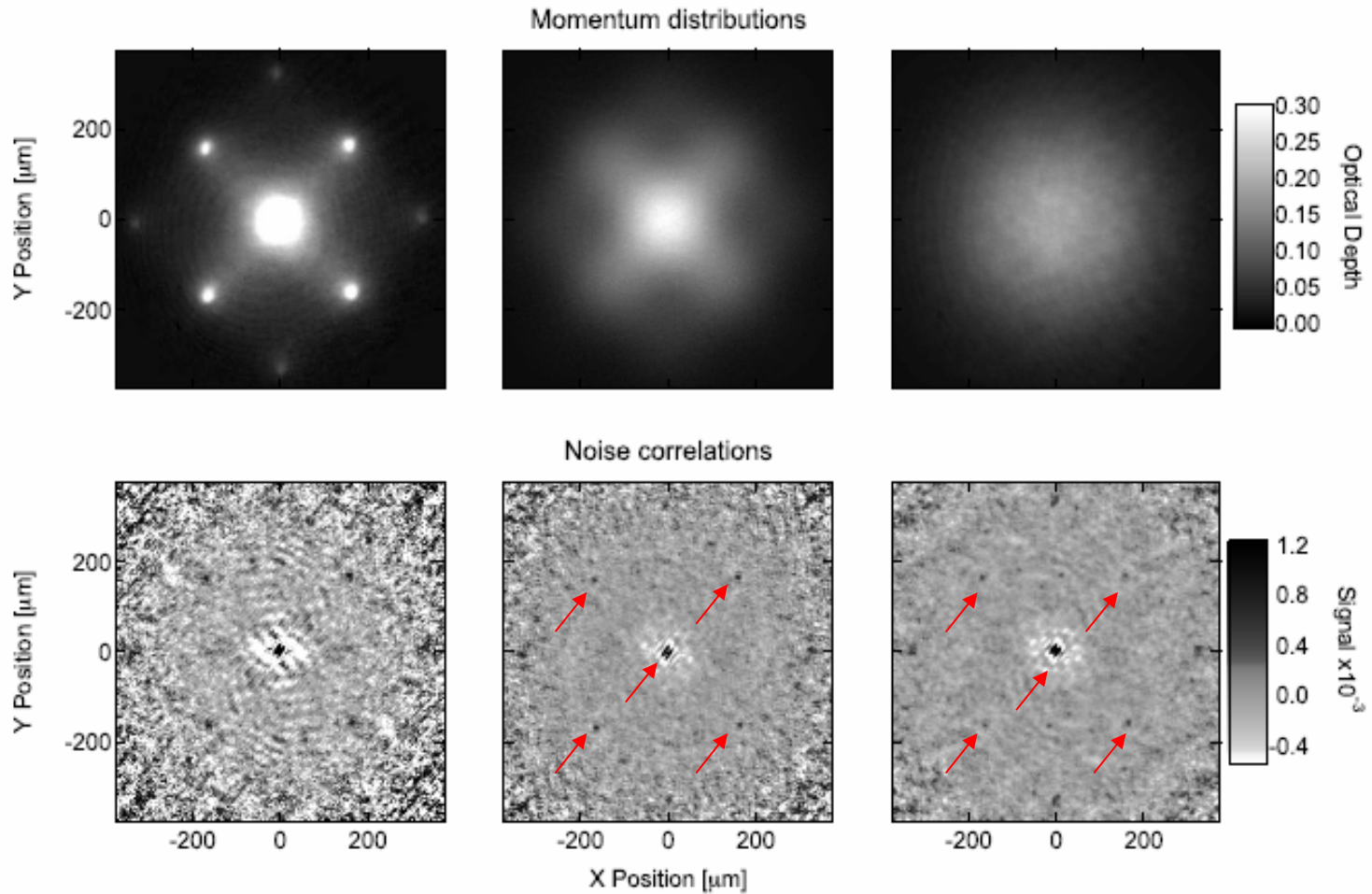

$$V / E_R = 12$$

$$V / E_R = 20$$

$$V / E_R = 21$$

Fermionic atoms in optical lattices

- Observation of Fermi surface. $^{40}\text{K} : |Fm\rangle = \left| \frac{99}{22} \right\rangle, \left| \frac{97}{22} \right\rangle$

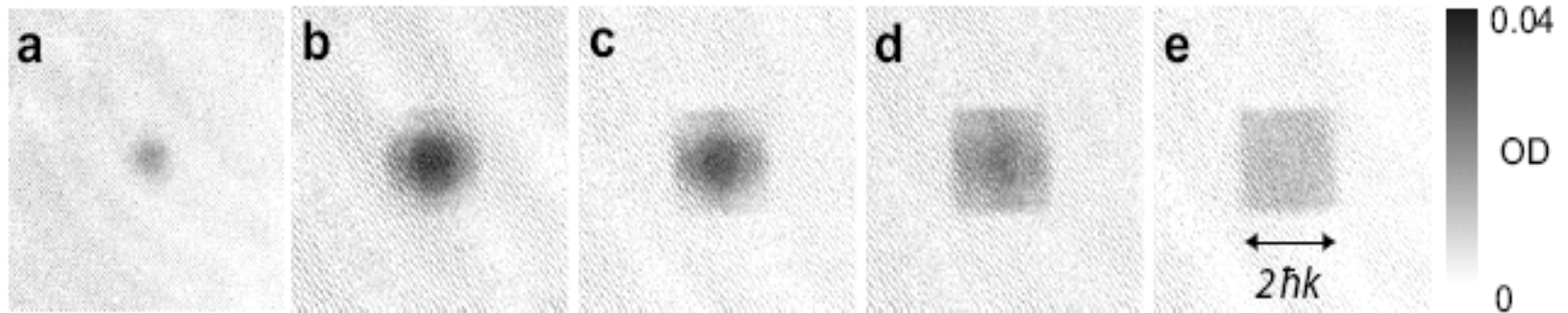

Low density: metal

high density: band insulator

Esslinger et al.,
PRL 94:80403
(2005)

Fermions with near-unitary interactions in the
presence of a periodic potential

Fermions with near-unitary interactions in the presence of a periodic potential

In the presence of a potential

$$V(\mathbf{r}) = V \left[\cos\left(\frac{2\pi x}{a_L}\right) + \cos\left(\frac{2\pi y}{a_L}\right) + \cos\left(\frac{2\pi z}{a_L}\right) \right]$$

there is a universal phase diagram determined by the ratio of 3 energy scales: V , the chemical potential μ , and the

recoil energy $E_r = \frac{\hbar^2}{4ma_L^2}$

Universal phase diagram of fermions with near-unitary interactions in the presence of a periodic potential

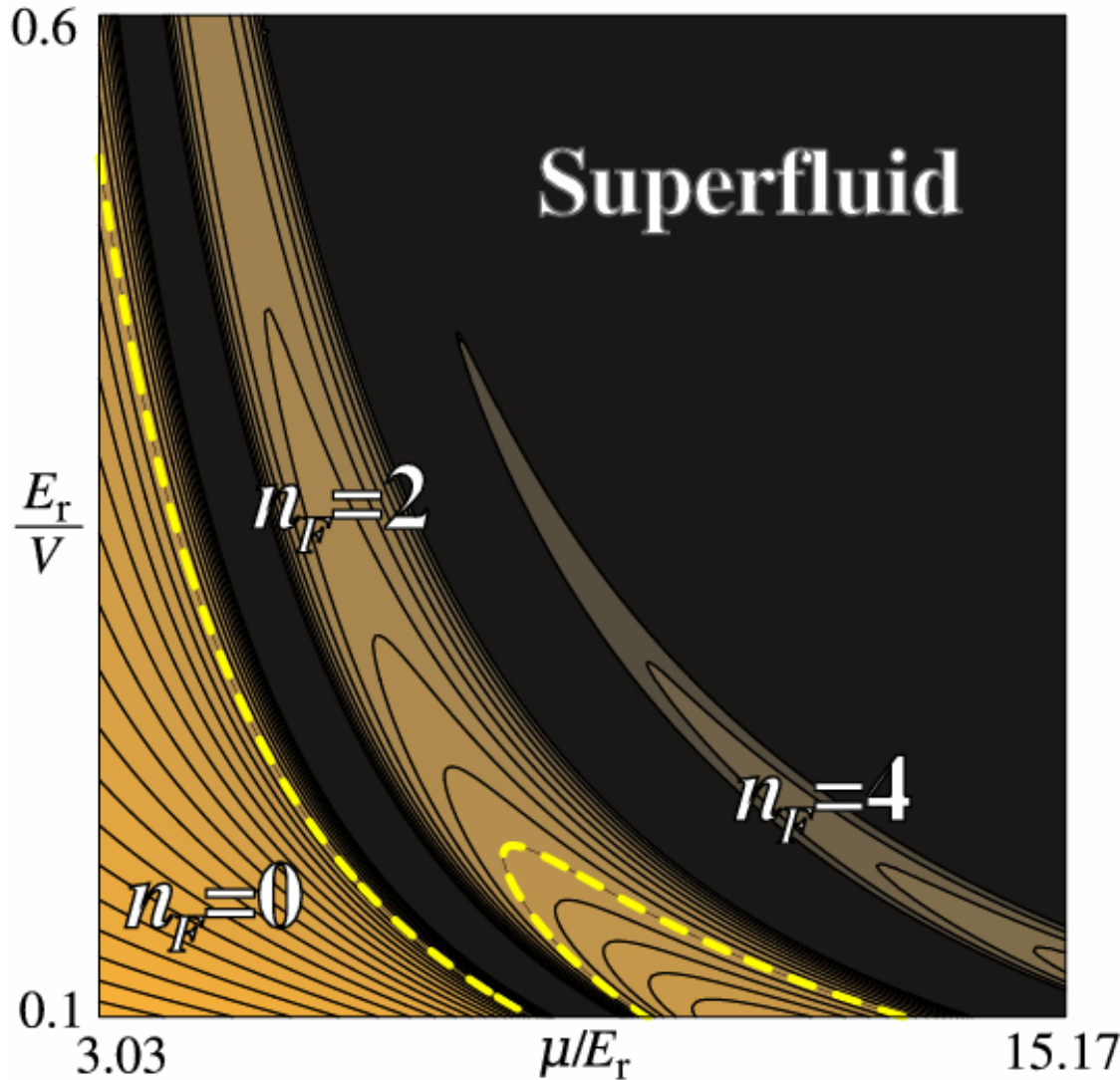

Expansion in $1/N$
with $Sp(2N)$
symmetry

Universal phase diagram of fermions with near-unitary interactions in the presence of a periodic potential

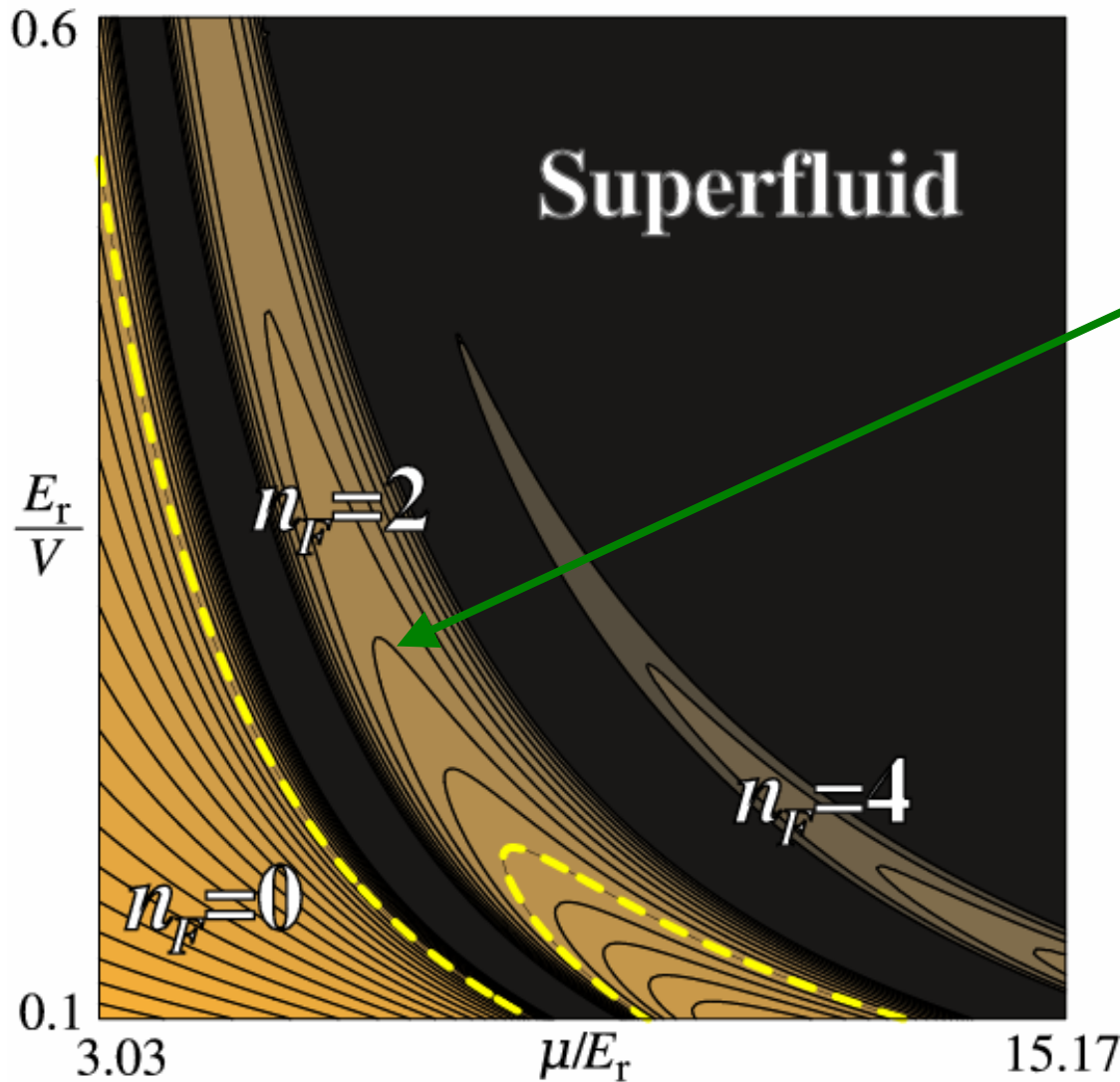

Boundaries to insulating phases for different values of va_L where v is the detuning from the resonance

Universal phase diagram of fermions with near-unitary interactions in the presence of a periodic potential

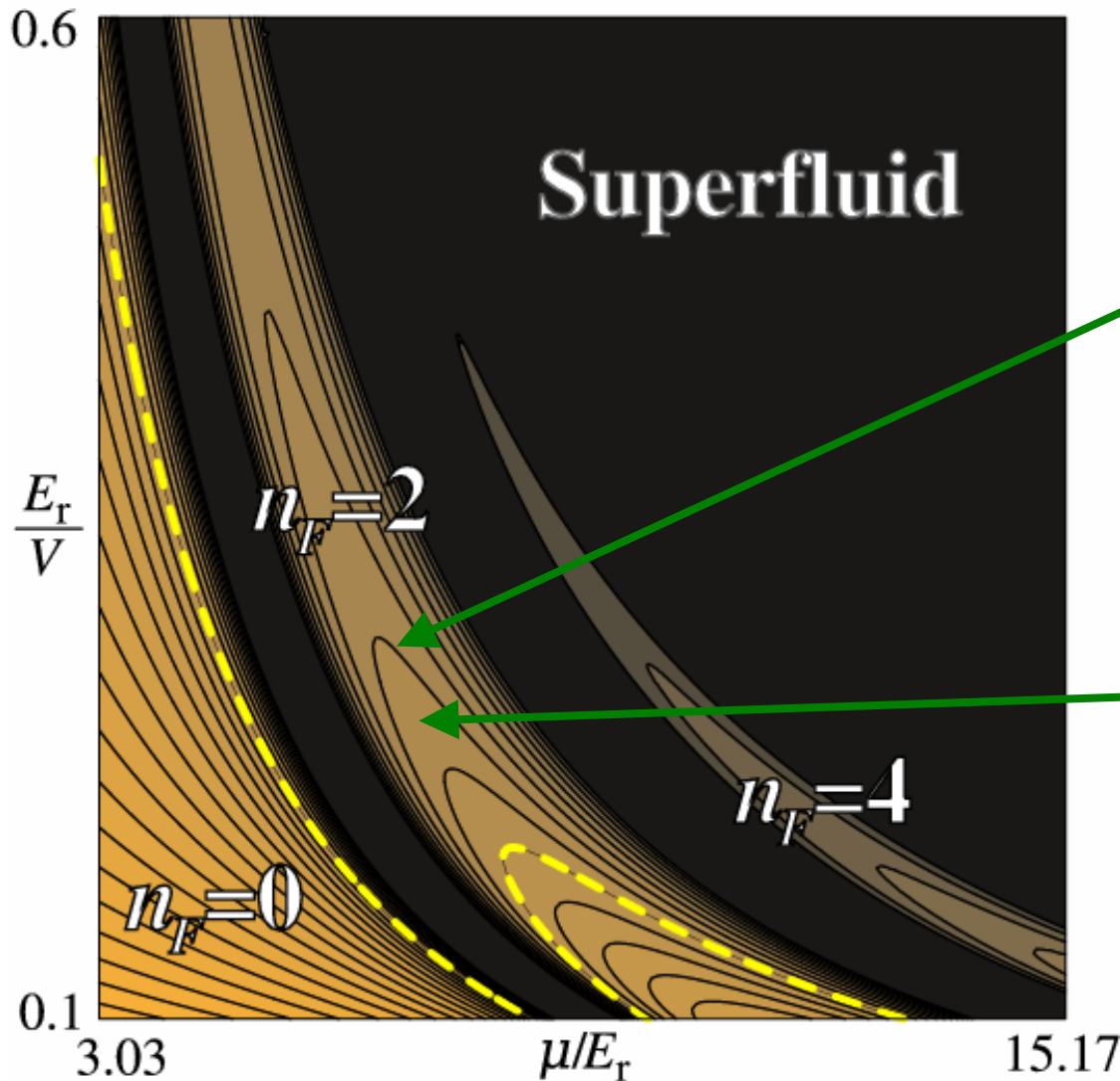

Boundaries to insulating phases for different values of νa_L where ν is the detuning from the resonance

Insulators have multiple band-occupancy, and are intermediate between band insulators of fermions and Mott insulators of bosonic fermion pairs

Artificial graphene in optical lattices

- Band Hamiltonian (σ -bonding) for spin-polarized fermions.

$$H_t = t_{//} \left\{ \sum_{\vec{r} \in A} [p_1^+(\vec{r}) p_1(\vec{r} + \hat{e}_1) + h.c.] \right. \\ \left. + [p_2^+(\vec{r}) p_1(\vec{r} + \hat{e}_2) + h.c.] \right. \\ \left. + [p_3^+(\vec{r}) p_3(\vec{r} + \hat{e}_3) + h.c.] \right\}$$

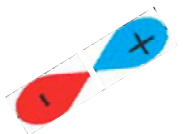
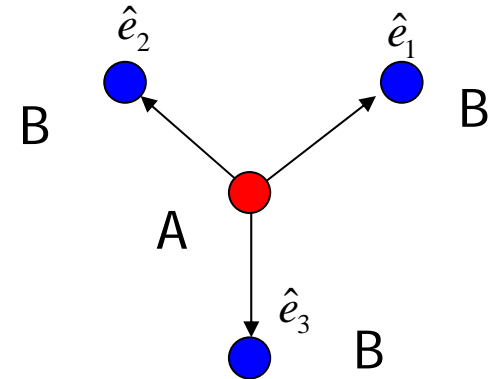

$$p_1 = \frac{\sqrt{3}}{2} p_x + \frac{1}{2} p_y$$

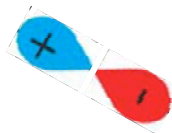

$$p_2 = \frac{\sqrt{3}}{2} p_x - \frac{1}{2} p_y$$



$$p_3 = -p_y$$

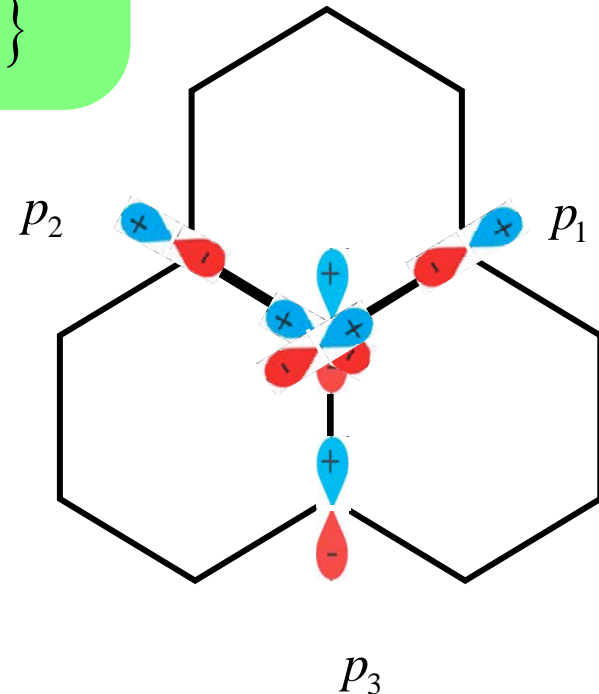

Flat bands in the entire Brillouin zone

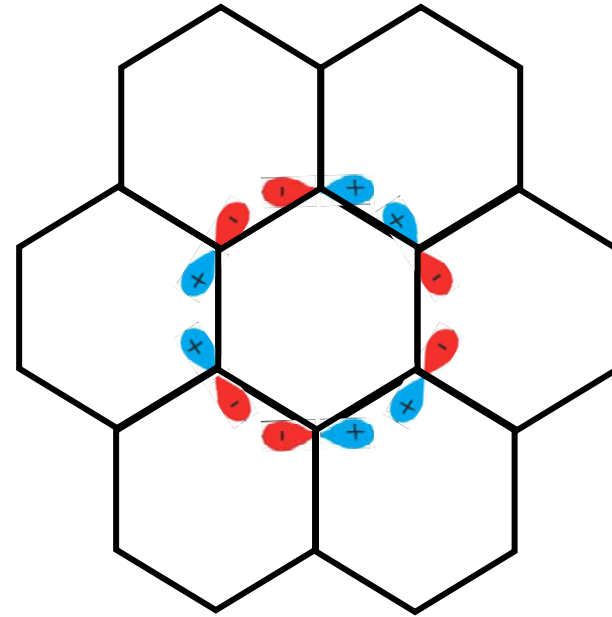
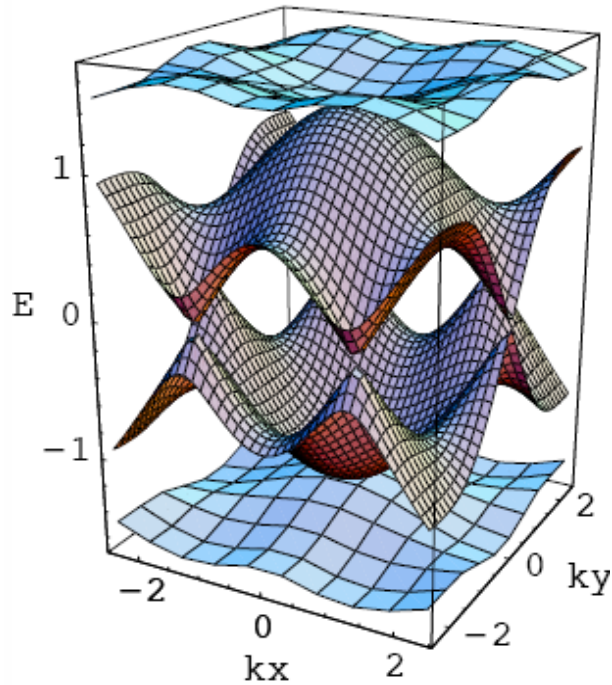

- Flat band + Dirac cone.

- localized eigenstates.

Many correlated phases possible

Outline

Strongly interacting cold atoms

1. Quantum liquids near unitarity:
from few-body to many-body physics
 - (a) Tonks gas in one dimension
 - (b) Paired fermions across a Feshbach resonance

2. Optical lattices
 - (a) Superfluid-insulator transition
 - (b) Quantum-critical hydrodynamics via mapping to quantum theory of black holes.
 - (c) Entanglement of valence bonds

Outline

Strongly interacting cold atoms

1. Quantum liquids near unitarity:
from few-body to many-body physics
 - (a) Tonks gas in one dimension
 - (b) Paired fermions across a Feshbach resonance

2. Optical lattices
 - (a) Superfluid-insulator transition
 - (b) Quantum-critical hydrodynamics via mapping to quantum theory of black holes.
 - (c) Entanglement of valence bonds

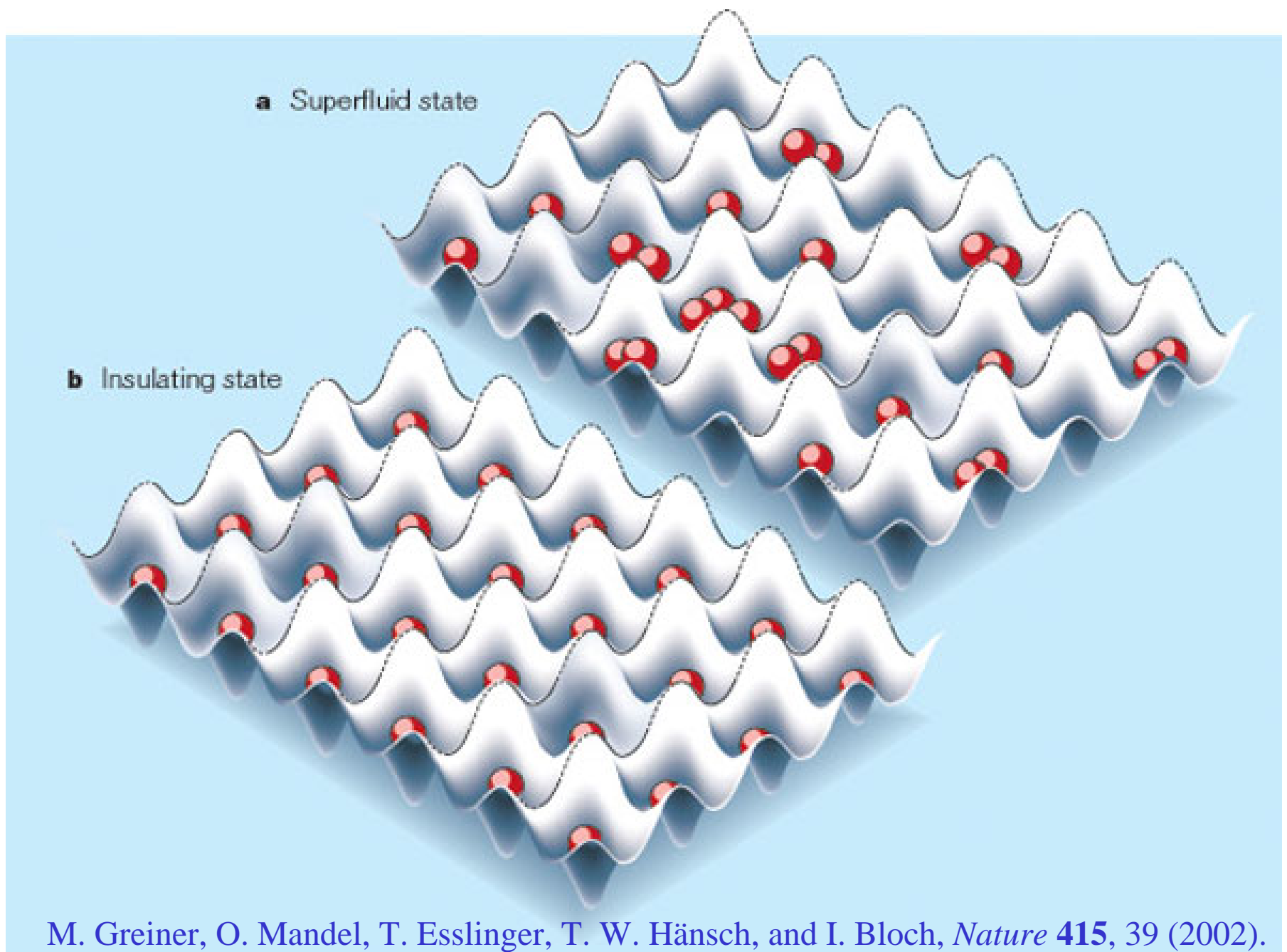

Non-zero temperature phase diagram

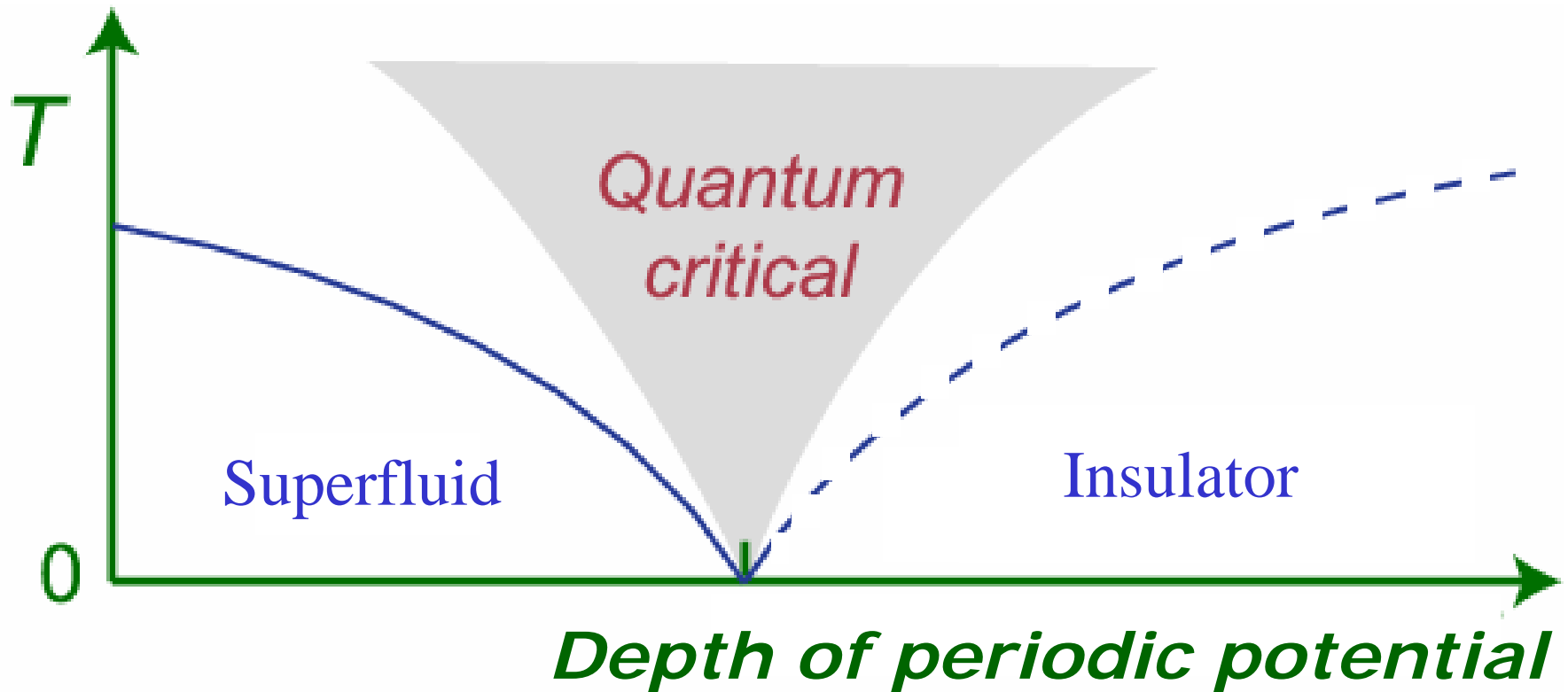

Non-zero temperature phase diagram

Dynamics of the classical
Gross-Pitaevski equation

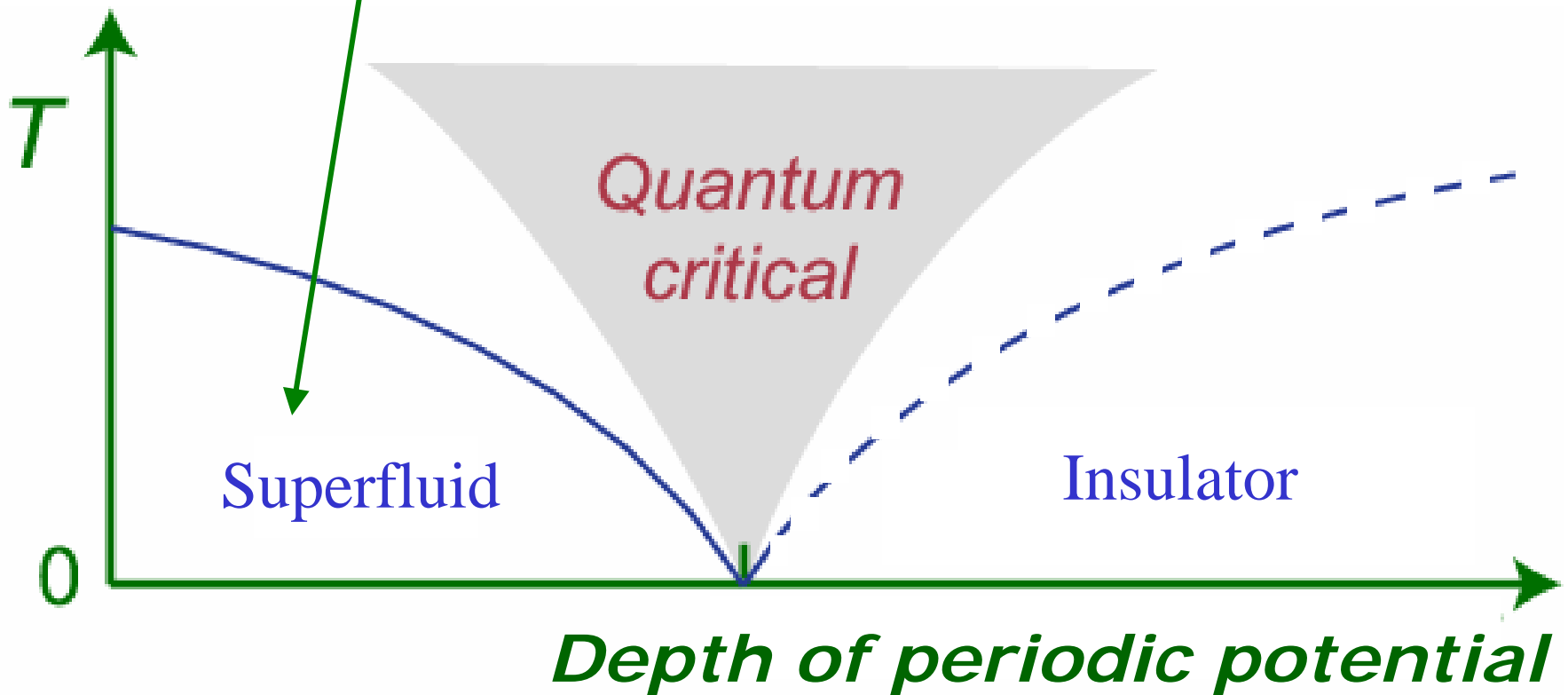

Non-zero temperature phase diagram

Dilute Boltzmann gas of
particle and holes

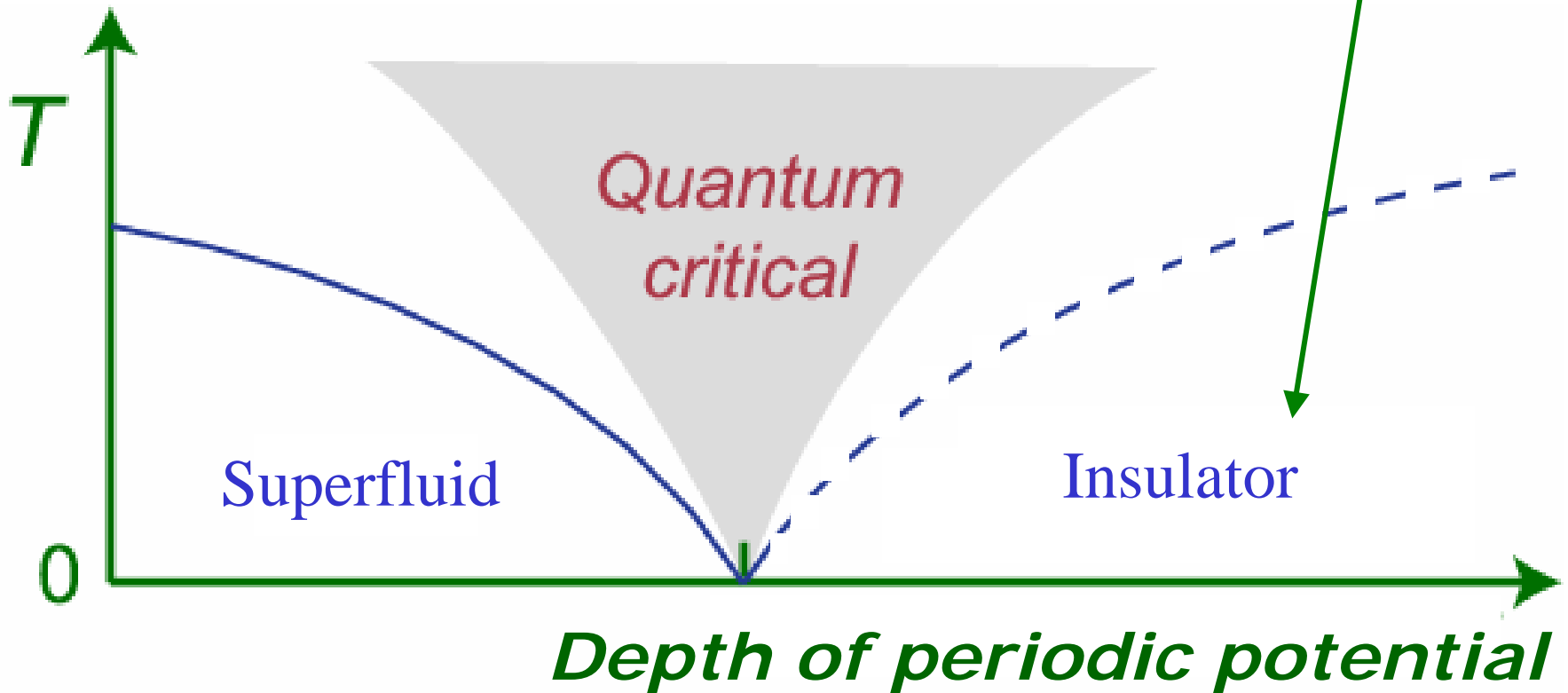

Non-zero temperature phase diagram

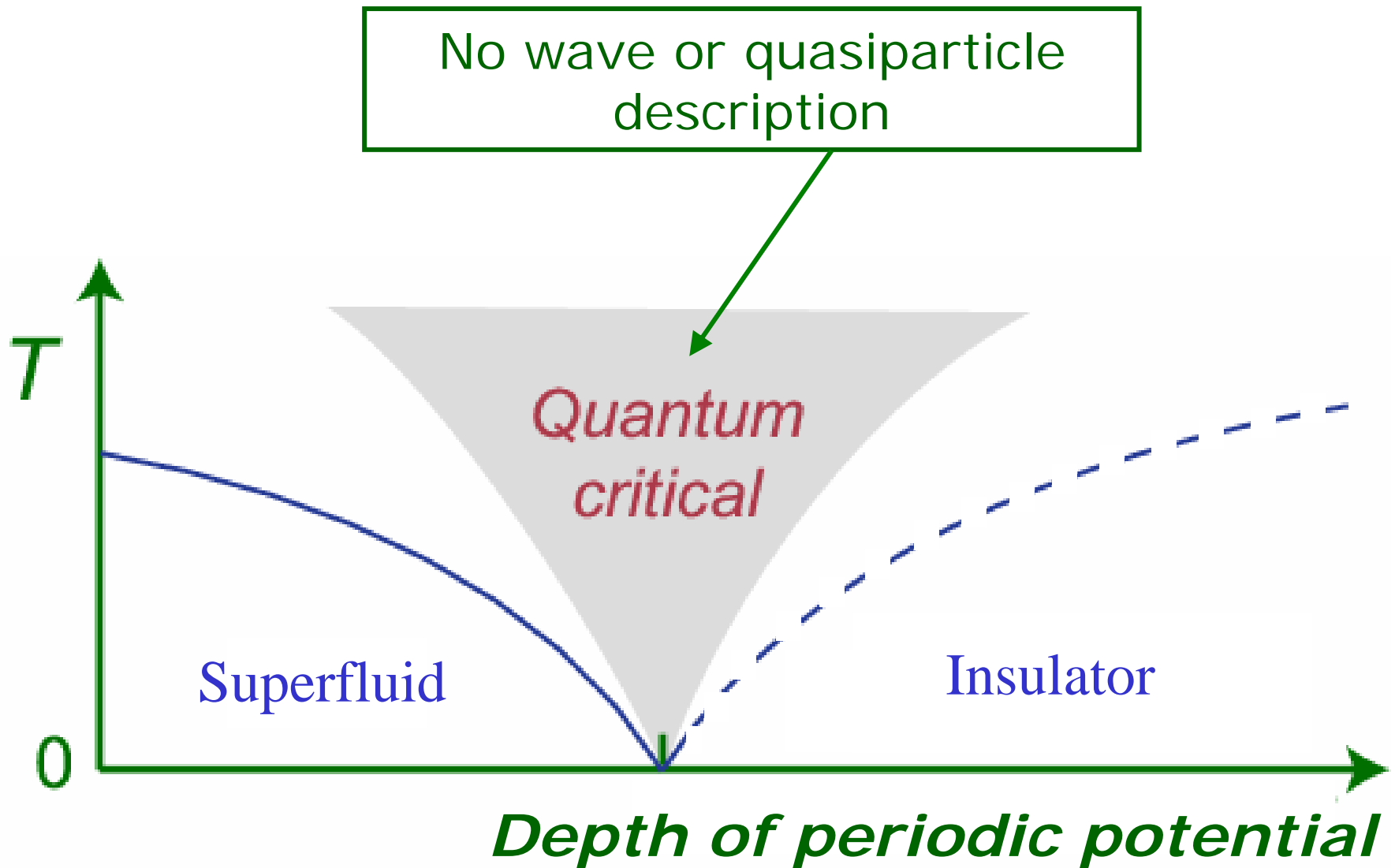

Resistivity of Bi films

Conductivity σ

$$\sigma_{\text{Superconductor}} (T \rightarrow 0) = \infty$$

$$\sigma_{\text{Insulator}} (T \rightarrow 0) = 0$$

$$\sigma_{\text{Quantum critical point}} (T \rightarrow 0) \approx \frac{4e^2}{h}$$

D. B. Haviland, Y. Liu, and A. M. Goldman,
Phys. Rev. Lett. **62**, 2180 (1989)

M. P. A. Fisher, *Phys. Rev. Lett.* **65**, 923 (1990)

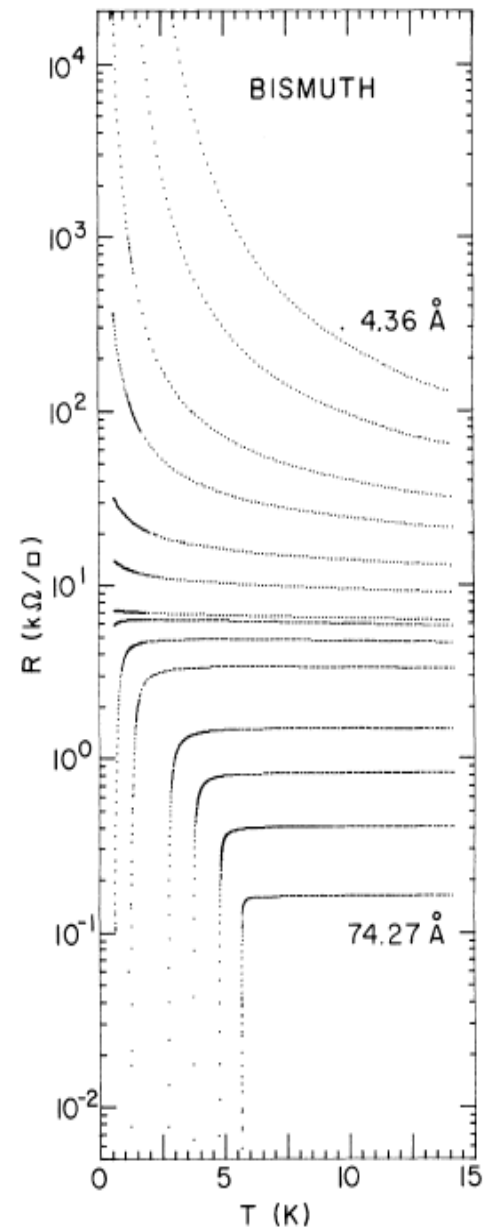
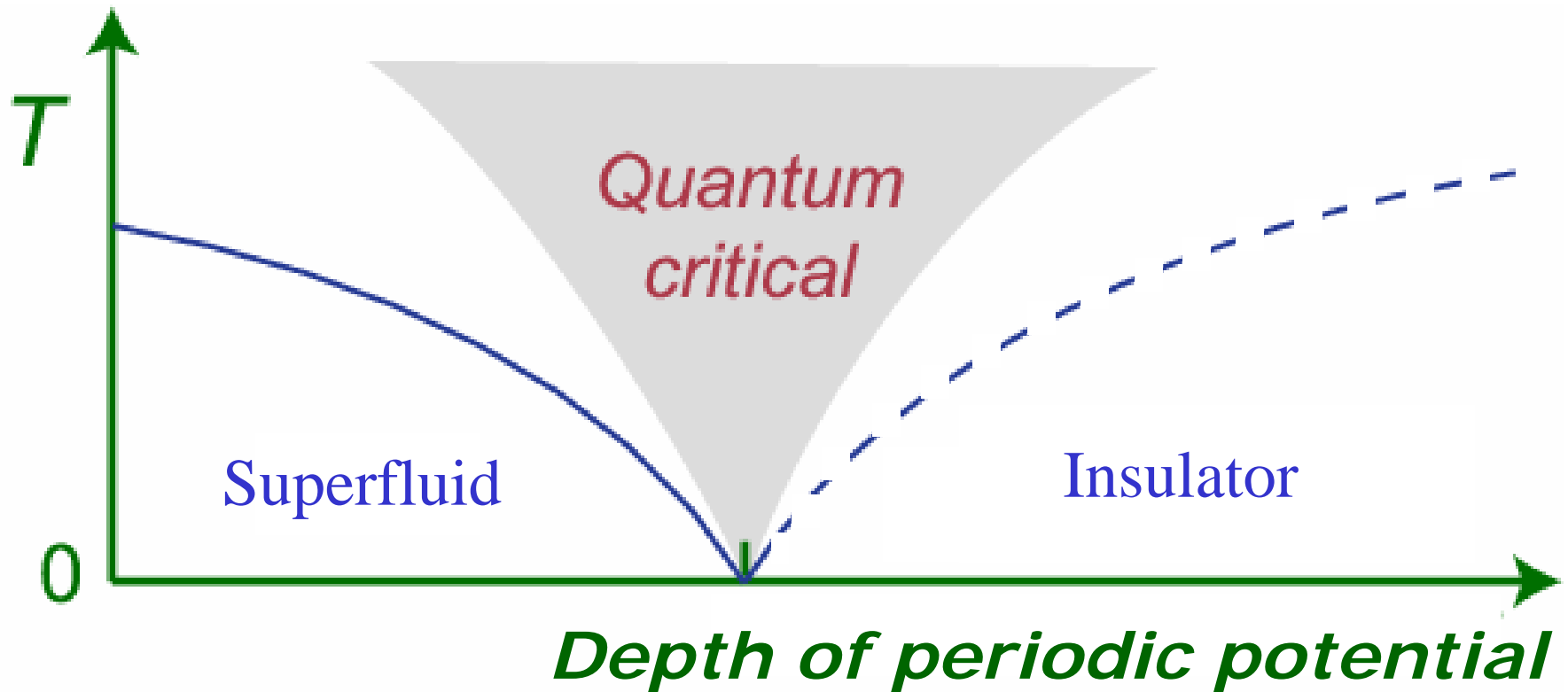
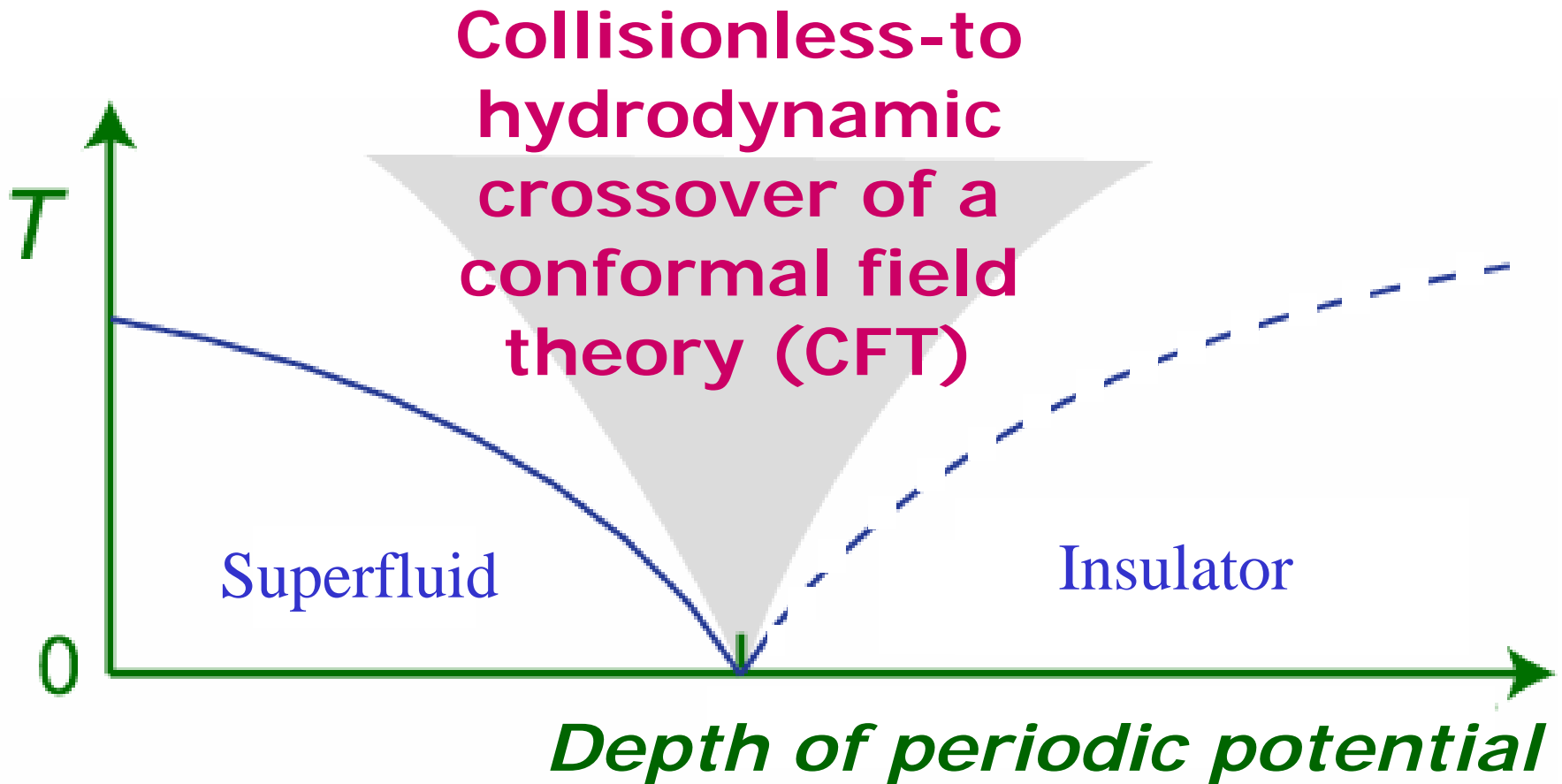

FIG. 1. Evolution of the temperature dependence of the sheet resistance $R(T)$ with thickness for a Bi film deposited onto Ge. Fewer than half of the traces actually acquired are shown. Film thicknesses shown range from 4.36 to 74.27 Å.

Non-zero temperature phase diagram



Non-zero temperature phase diagram



Non-zero temperature phase diagram

Needed: Cold atom experiments in this regime

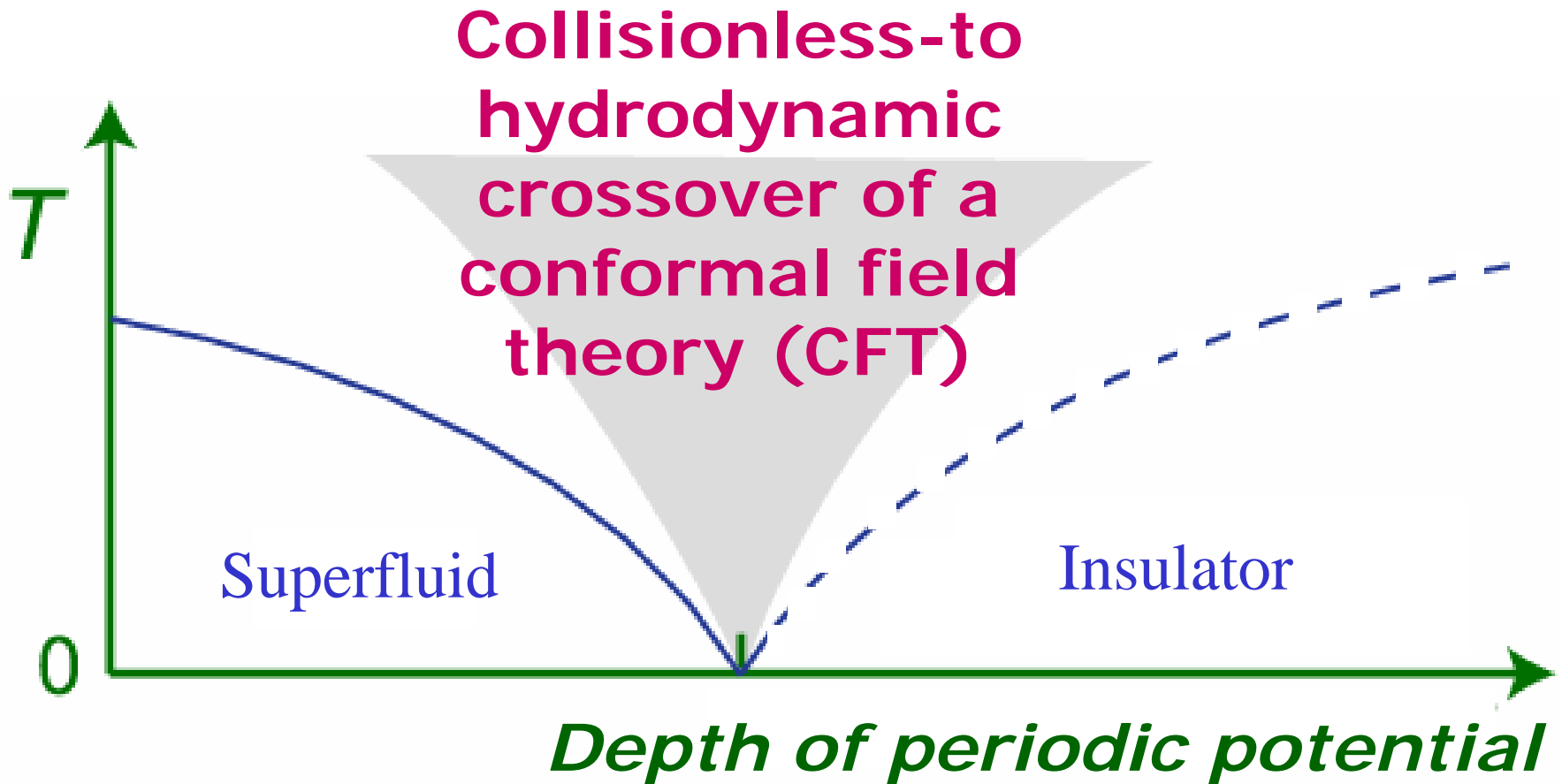

Hydrodynamics of a conformal field theory (CFT)

Maldacena's AdS/CFT correspondence relates the hydrodynamics of CFTs to the quantum gravity theory of the horizon of a black hole in Anti-de Sitter space.

Hydrodynamics of a conformal field theory (CFT)

Maldacena's AdS/CFT correspondence relates the hydrodynamics of CFTs to the quantum gravity theory of the horizon of a black hole in Anti-de Sitter space.

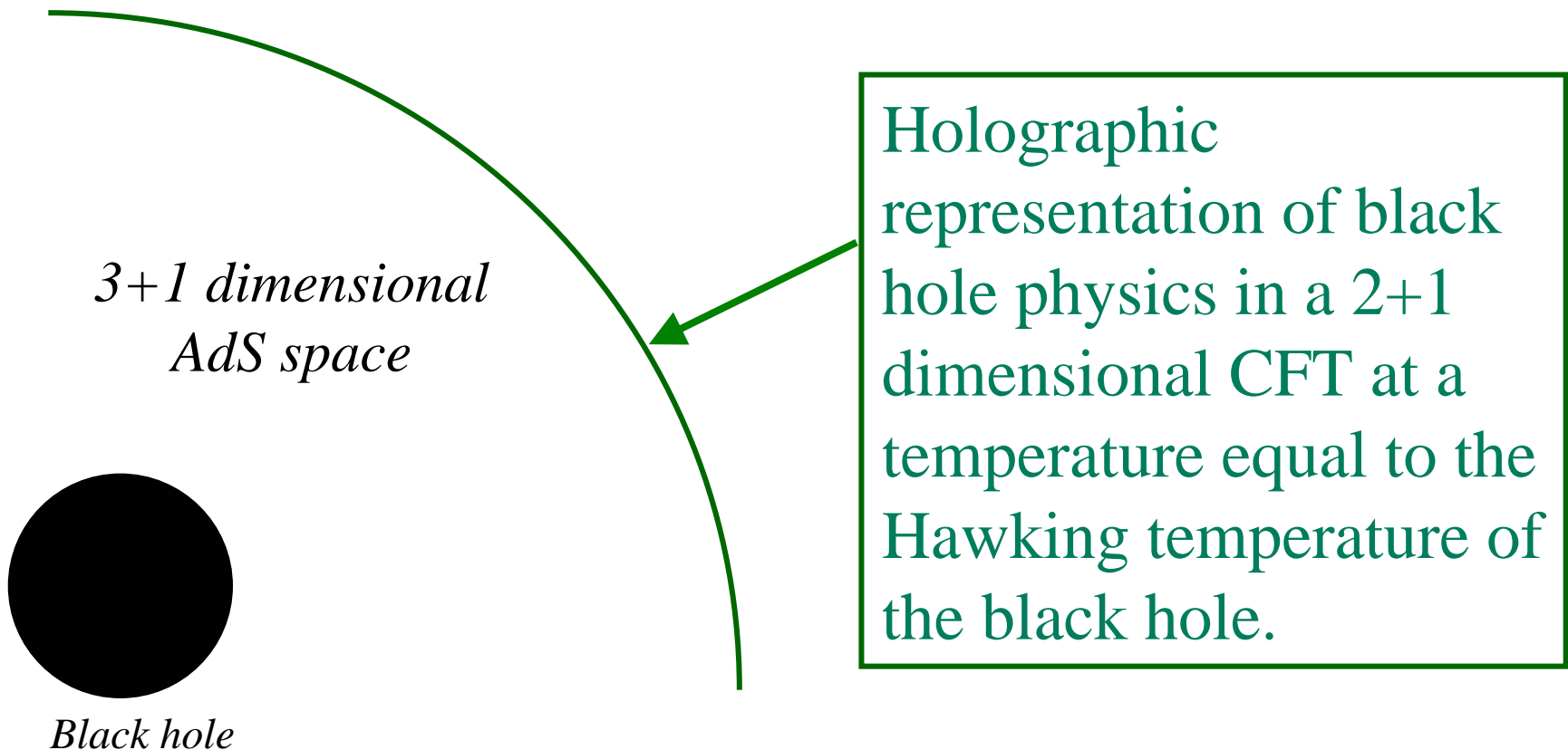

Hydrodynamics of a conformal field theory (CFT)

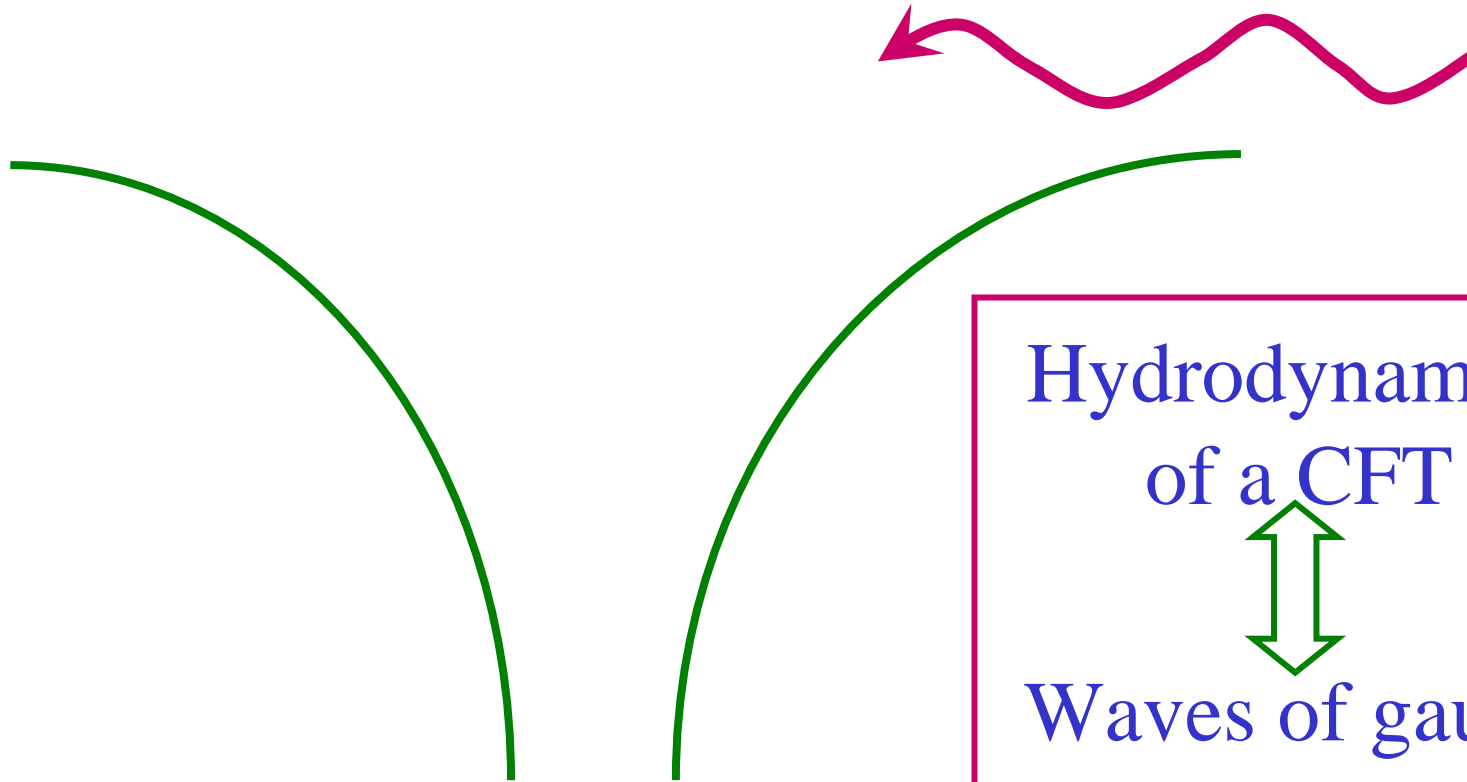

Hydrodynamics
of a CFT



Waves of gauge
fields in a curved
background

Hydrodynamics of a conformal field theory (CFT)

The scattering cross-section of the thermal excitations is universal and so transport coefficients are universally determined by $k_B T$

Charge diffusion constant

$$D_c = \Theta \frac{c^2}{k_B T}$$

Conductivity

$$\sigma = \Theta \frac{4e^2}{h}$$

Hydrodynamics of a conformal field theory (CFT)

For the (unique) CFT with a $SU(N)$ gauge field and 16 supercharges, we know the exact diffusion constant associated with a global $SO(8)$ symmetry:

Spin diffusion constant

$$D_s = \frac{3}{4\pi} \frac{c^2}{k_B T}$$

Spin conductivity

$$\sigma = \frac{N^{3/2}}{3\sqrt{2}\pi}$$

Outline

Strongly interacting cold atoms

1. Quantum liquids near unitarity:
from few-body to many-body physics
 - (a) Tonks gas in one dimension
 - (b) Paired fermions across a Feshbach resonance

2. Optical lattices
 - (a) Superfluid-insulator transition
 - (b) Quantum-critical hydrodynamics via mapping to quantum theory of black holes.
 - (c) Entanglement of valence bonds

Outline

Strongly interacting cold atoms

1. Quantum liquids near unitarity:
from few-body to many-body physics
 - (a) Tonks gas in one dimension
 - (b) Paired fermions across a Feshbach resonance

2. Optical lattices
 - (a) Superfluid-insulator transition
 - (b) Quantum-critical hydrodynamics via mapping to quantum theory of black holes.
 - (c) Entanglement of valence bonds

Ring-exchange interactions in an optical lattice using a Raman transition

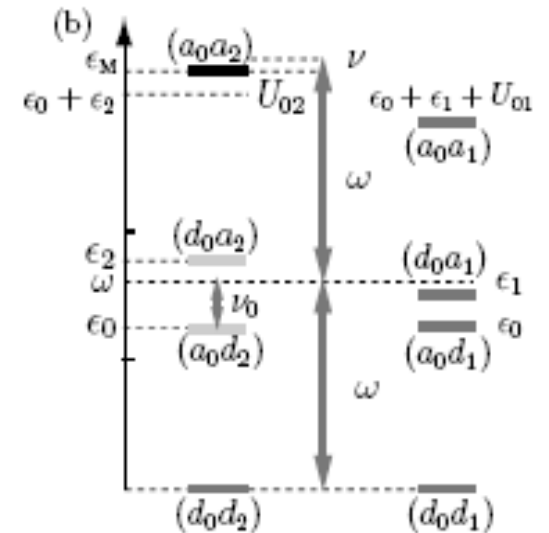
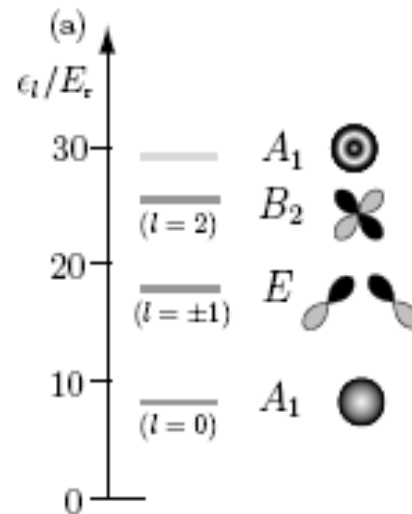
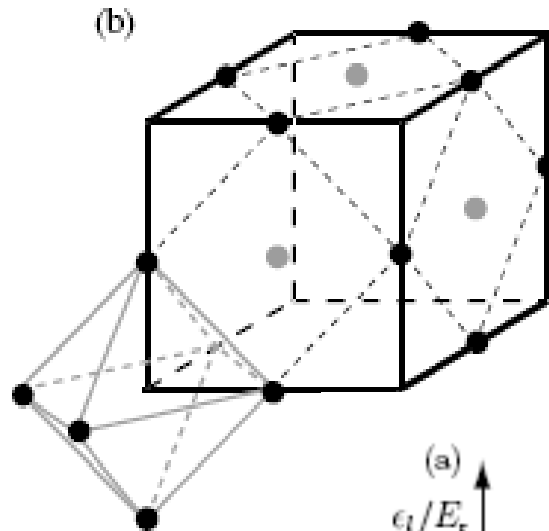
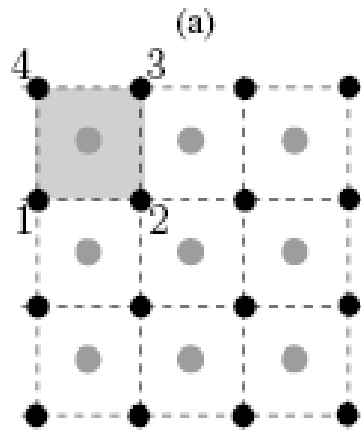

At each site, identify the states $|\uparrow\rangle$, $|\downarrow\rangle$, with the occupation number of a hard-core boson:

$$\begin{aligned}|\downarrow\rangle &= |0\rangle \\ |\uparrow\rangle &= b^\dagger|0\rangle\end{aligned}$$

Then the spin operators map as follows

$$\begin{aligned}S_z &= b^\dagger b - 1/2 \\ S_+ &= b^\dagger \\ S_- &= b\end{aligned}$$

Antiferromagnetic (Neel) order in the insulator

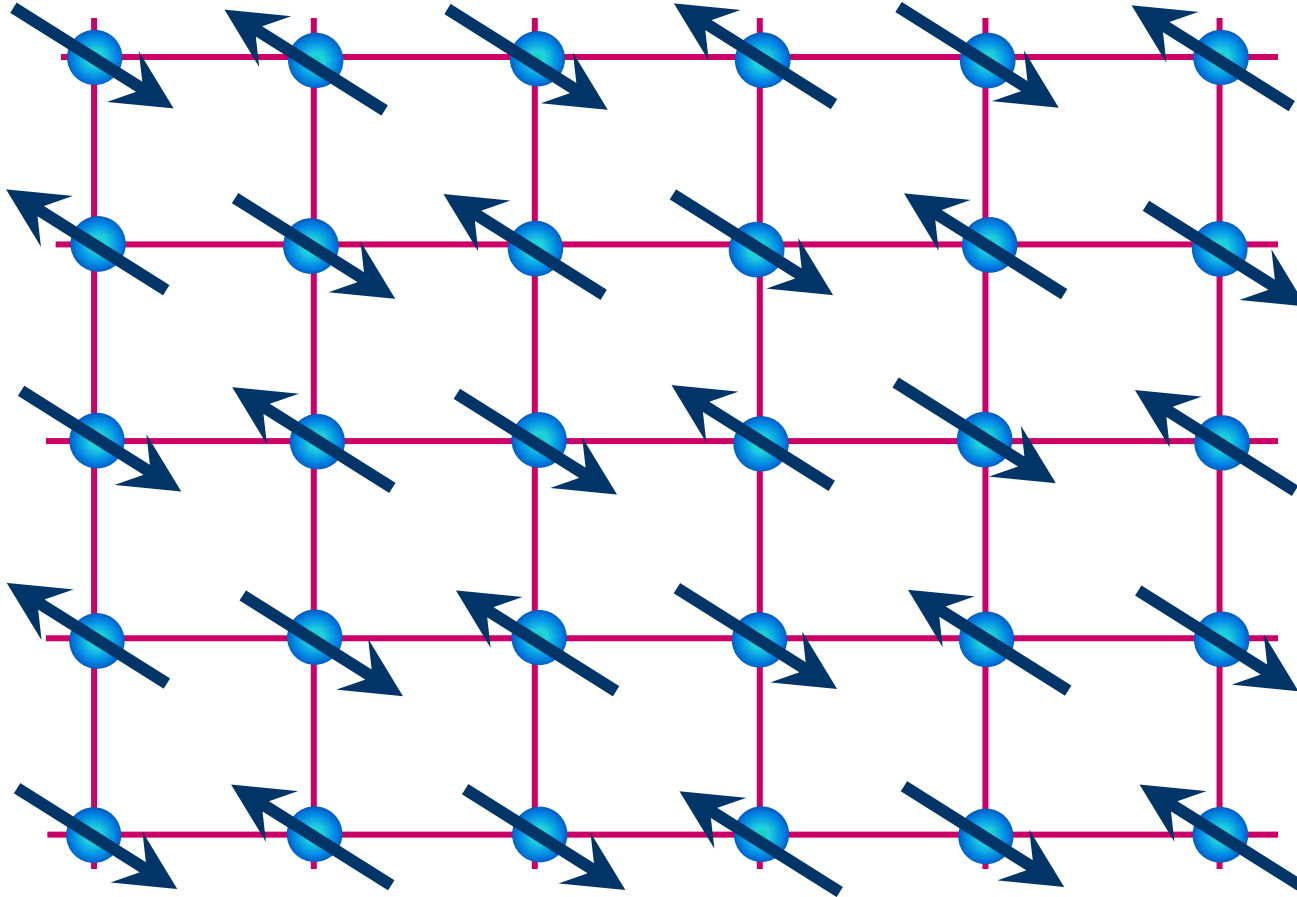

$$H = J \sum_{\langle ij \rangle} \vec{S}_i \cdot \vec{S}_j \quad ; \quad \vec{S}_i \Rightarrow \text{spin operator with } S=1/2$$

Induce formation of valence bonds by
e.g. ring-exchange interactions

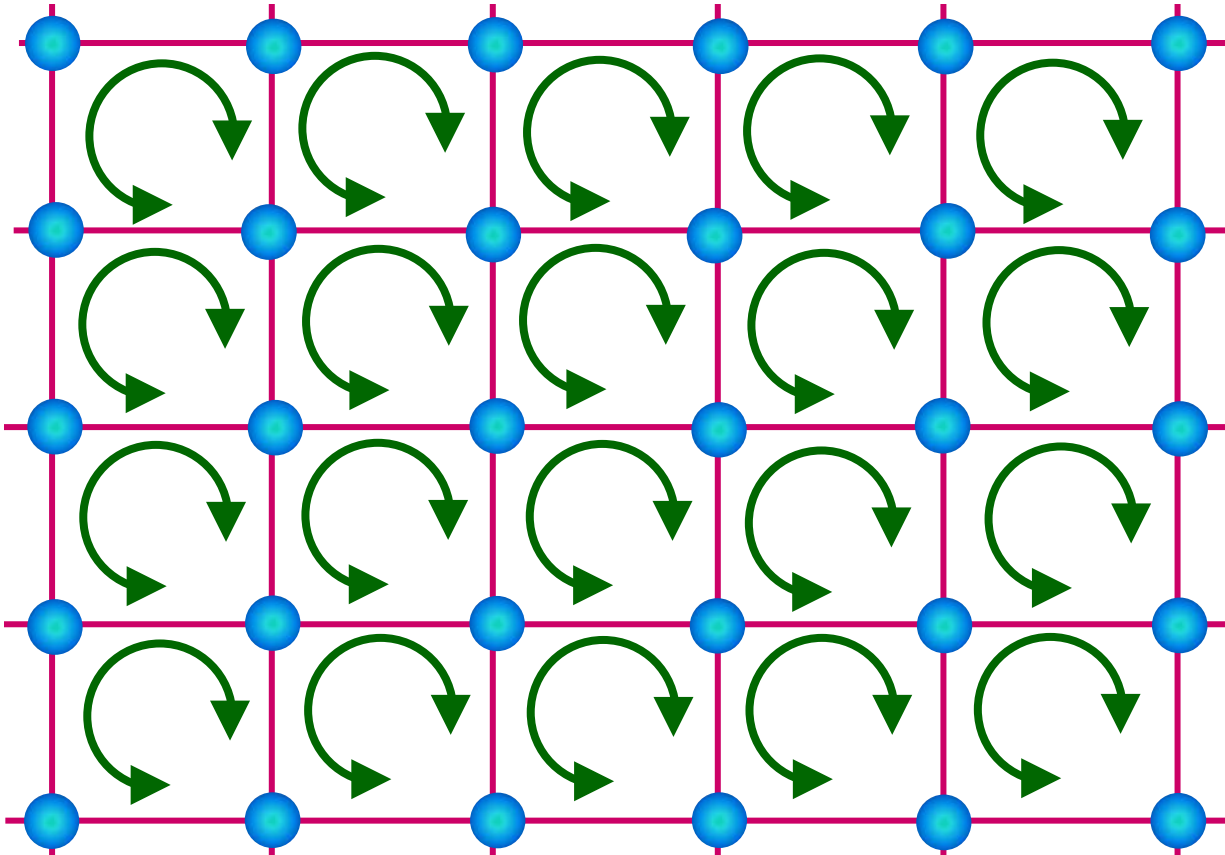

$$H = J \sum_{\langle ij \rangle} \vec{S}_i \cdot \vec{S}_j + K \sum_{\square} 4\text{-spin exchange}$$

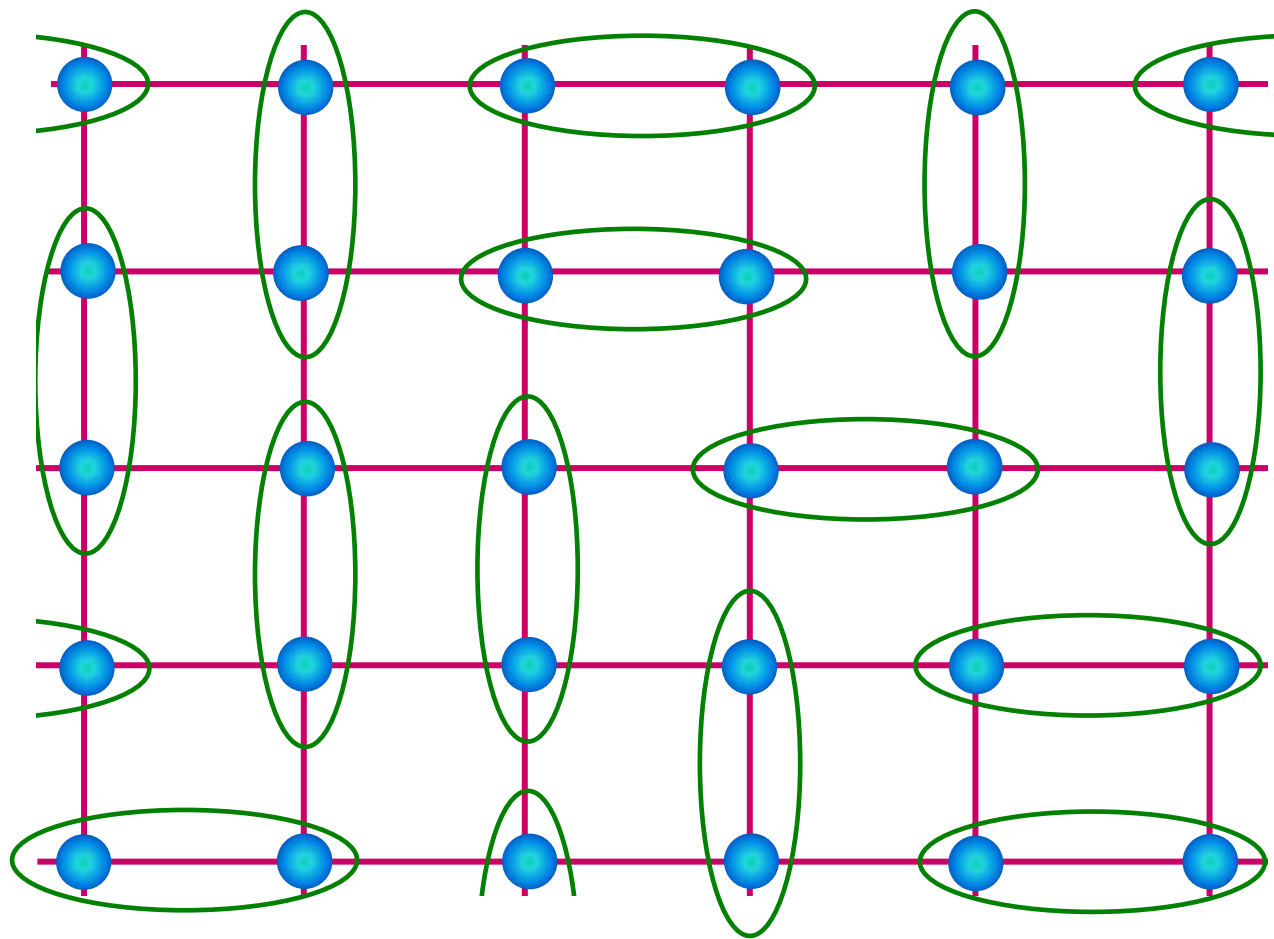

$$\text{Oval} = \frac{1}{\sqrt{2}} (|\uparrow\downarrow\rangle - |\downarrow\uparrow\rangle)$$

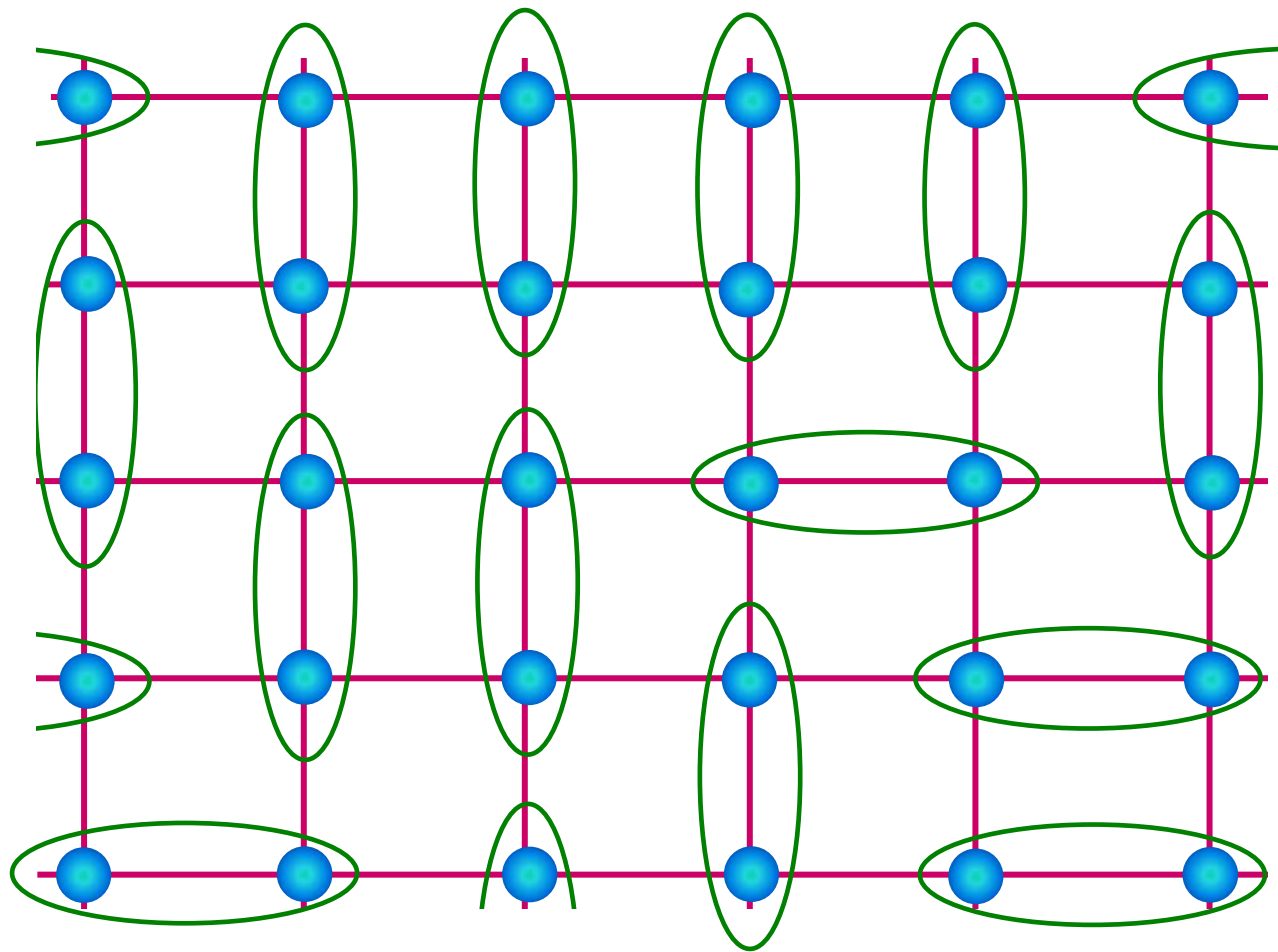

$$\text{Oval} = \frac{1}{\sqrt{2}} (|\uparrow\downarrow\rangle - |\downarrow\uparrow\rangle)$$

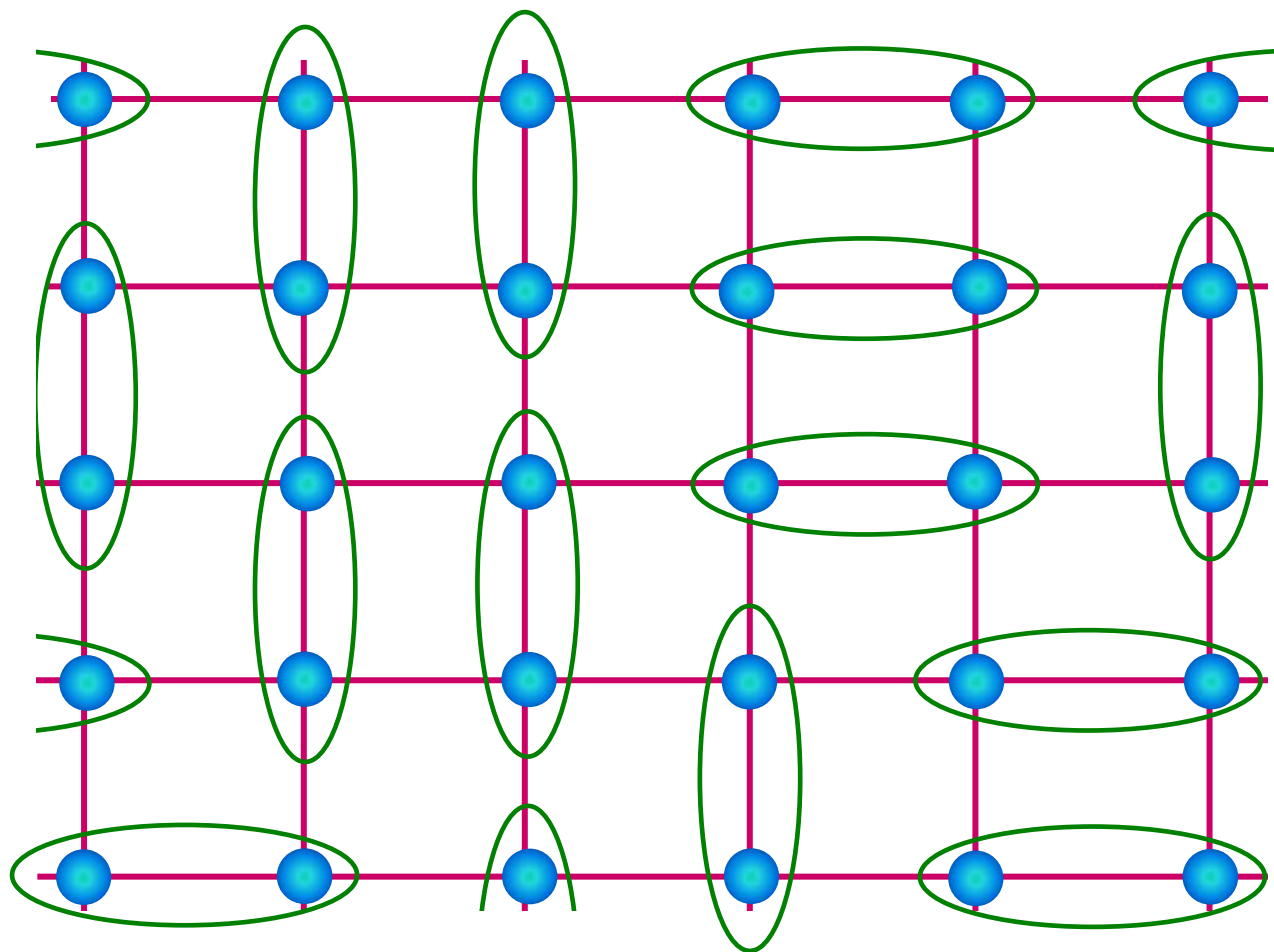

$$\begin{array}{c}
 \text{Oval with two blue spheres} \\
 = \\
 \frac{1}{\sqrt{2}} (|\uparrow\downarrow\rangle - |\downarrow\uparrow\rangle)
 \end{array}$$

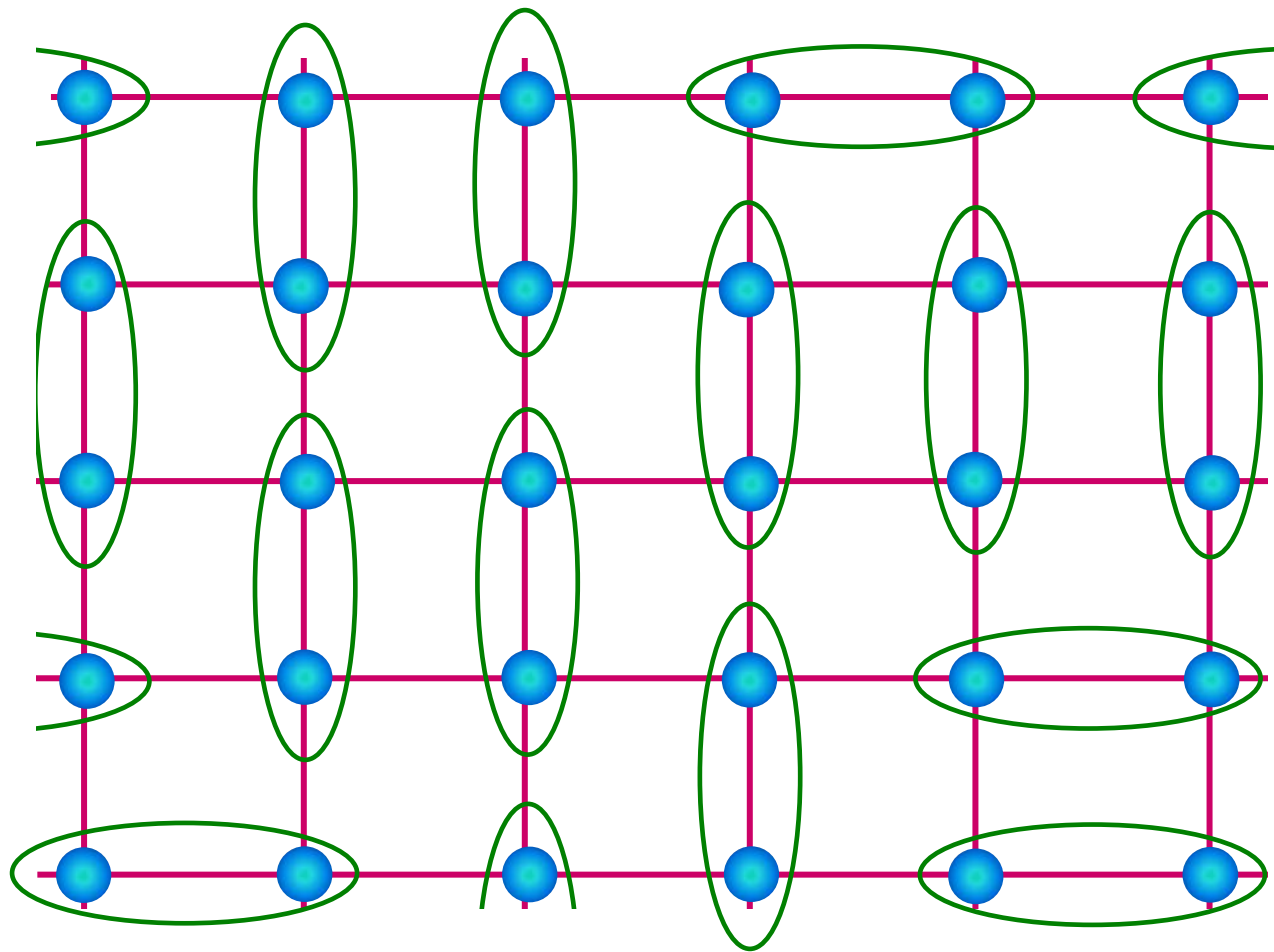

$$\text{Oval} = \frac{1}{\sqrt{2}} (|\uparrow\downarrow\rangle - |\downarrow\uparrow\rangle)$$

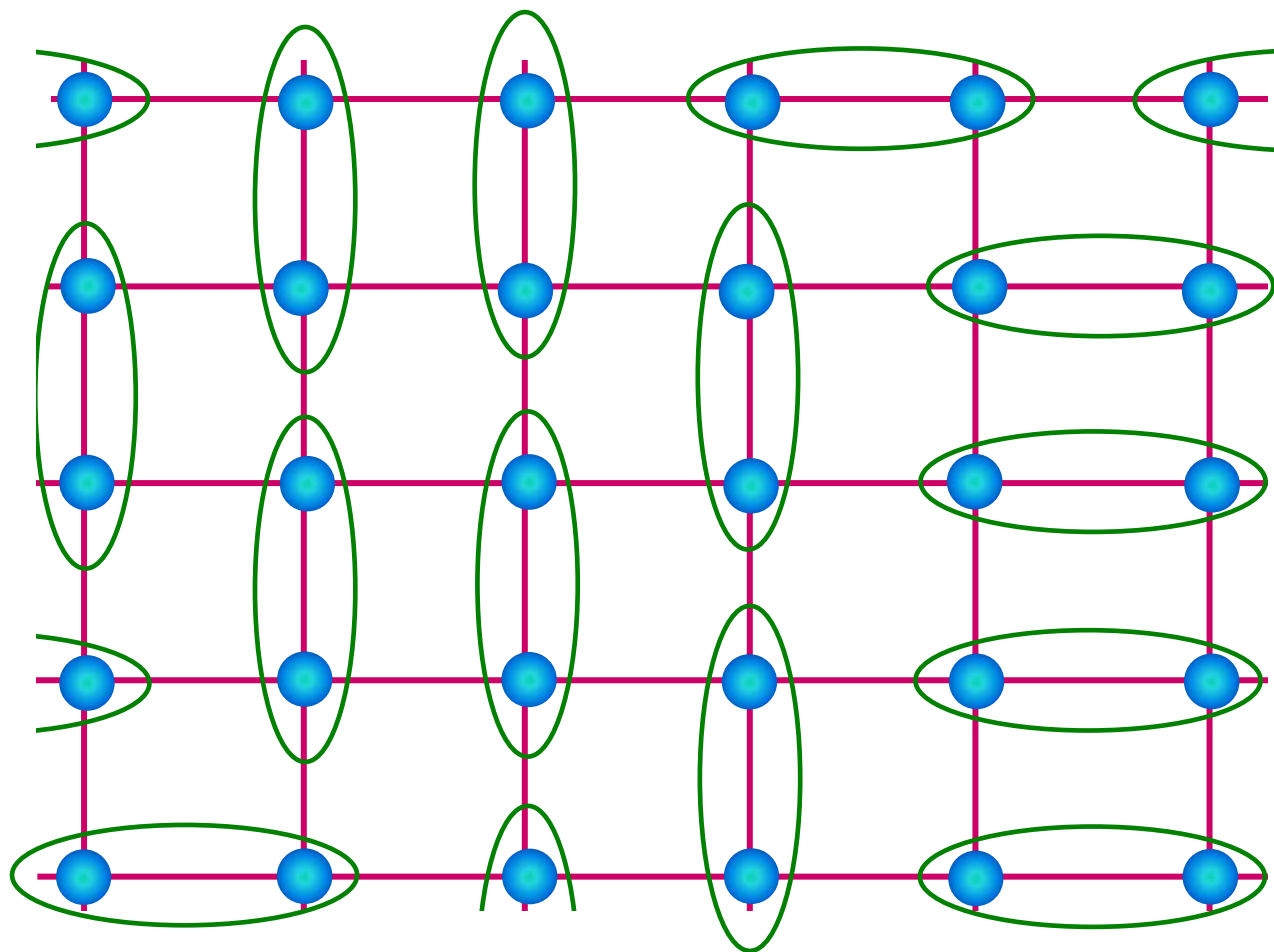

$$\begin{array}{c}
 \text{[Green Oval with 2 Blue Spheres]} = \\
 \frac{1}{\sqrt{2}} (|\uparrow\downarrow\rangle - |\downarrow\uparrow\rangle)
 \end{array}$$

Entangled liquid of valence bonds (Resonating valence bonds – RVB)

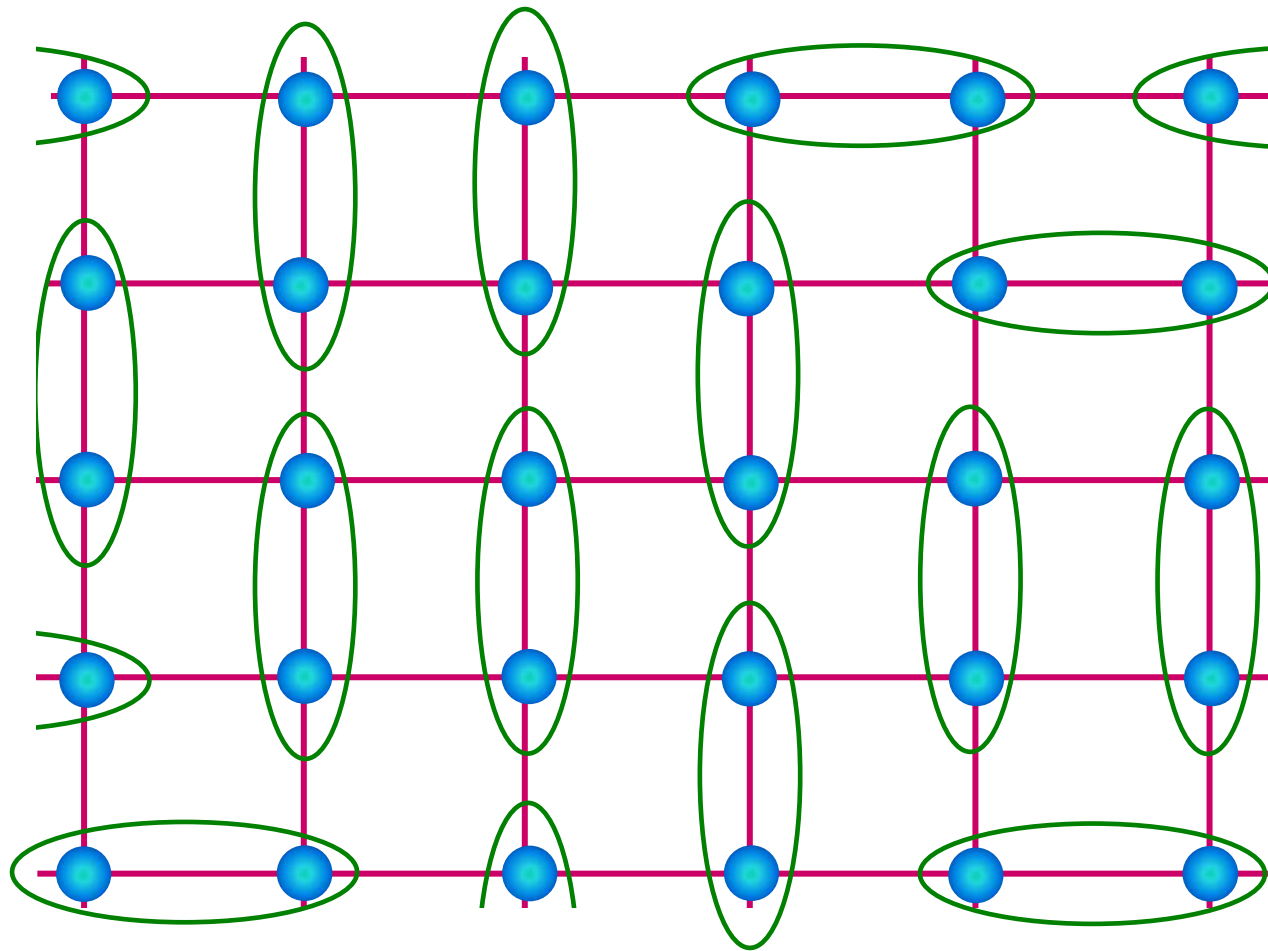

$$\text{oval} = \frac{1}{\sqrt{2}} (|\uparrow\downarrow\rangle - |\downarrow\uparrow\rangle)$$

Valence bond solid (VBS)

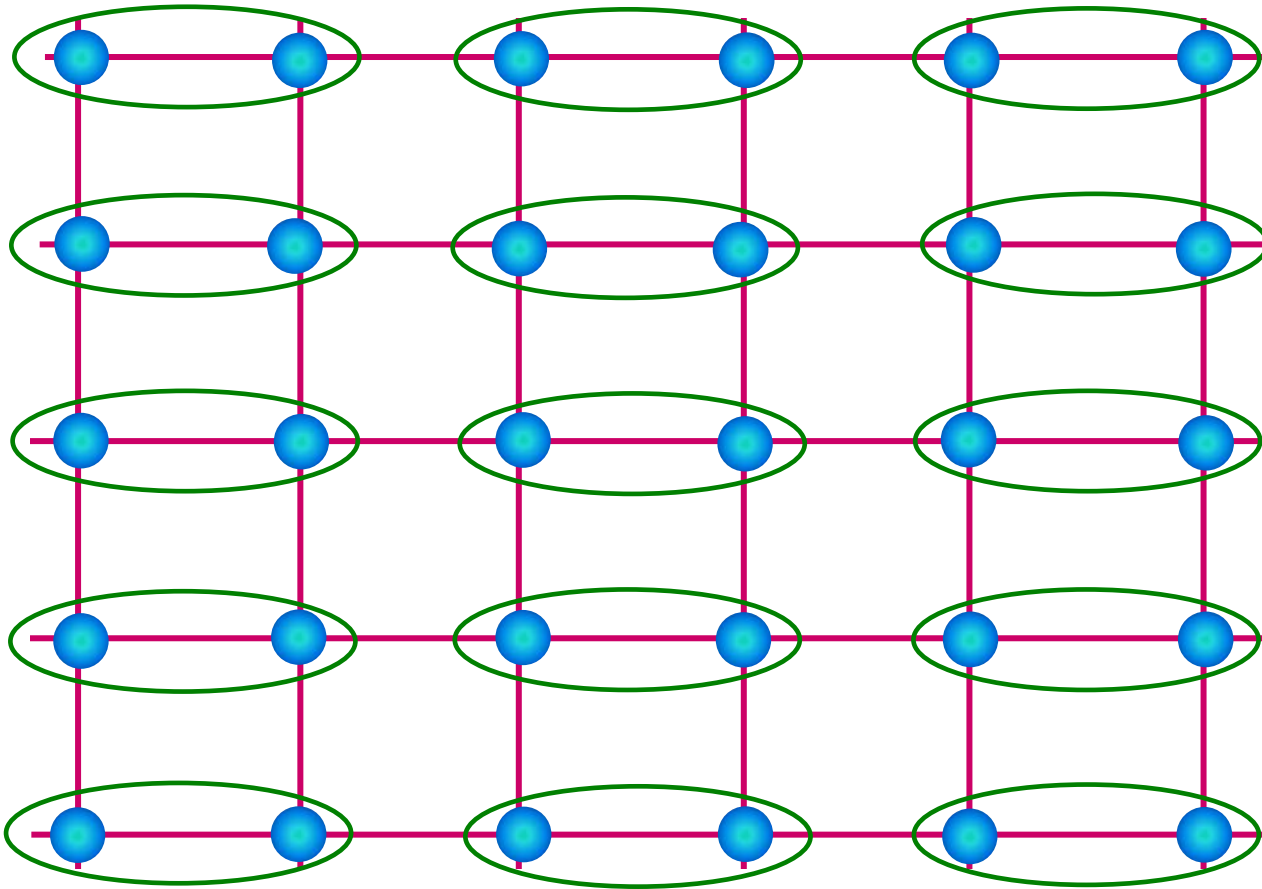

$$\text{green oval with two blue spheres} = \frac{1}{\sqrt{2}} (|\uparrow\downarrow\rangle - |\downarrow\uparrow\rangle)$$

N. Read and S. Sachdev,
Phys. Rev. Lett. **62**, 1694
(1989).

R. Moessner and S. L.
Sondhi, *Phys. Rev. B* **63**,
224401 (2001).

Valence bond solid (VBS)

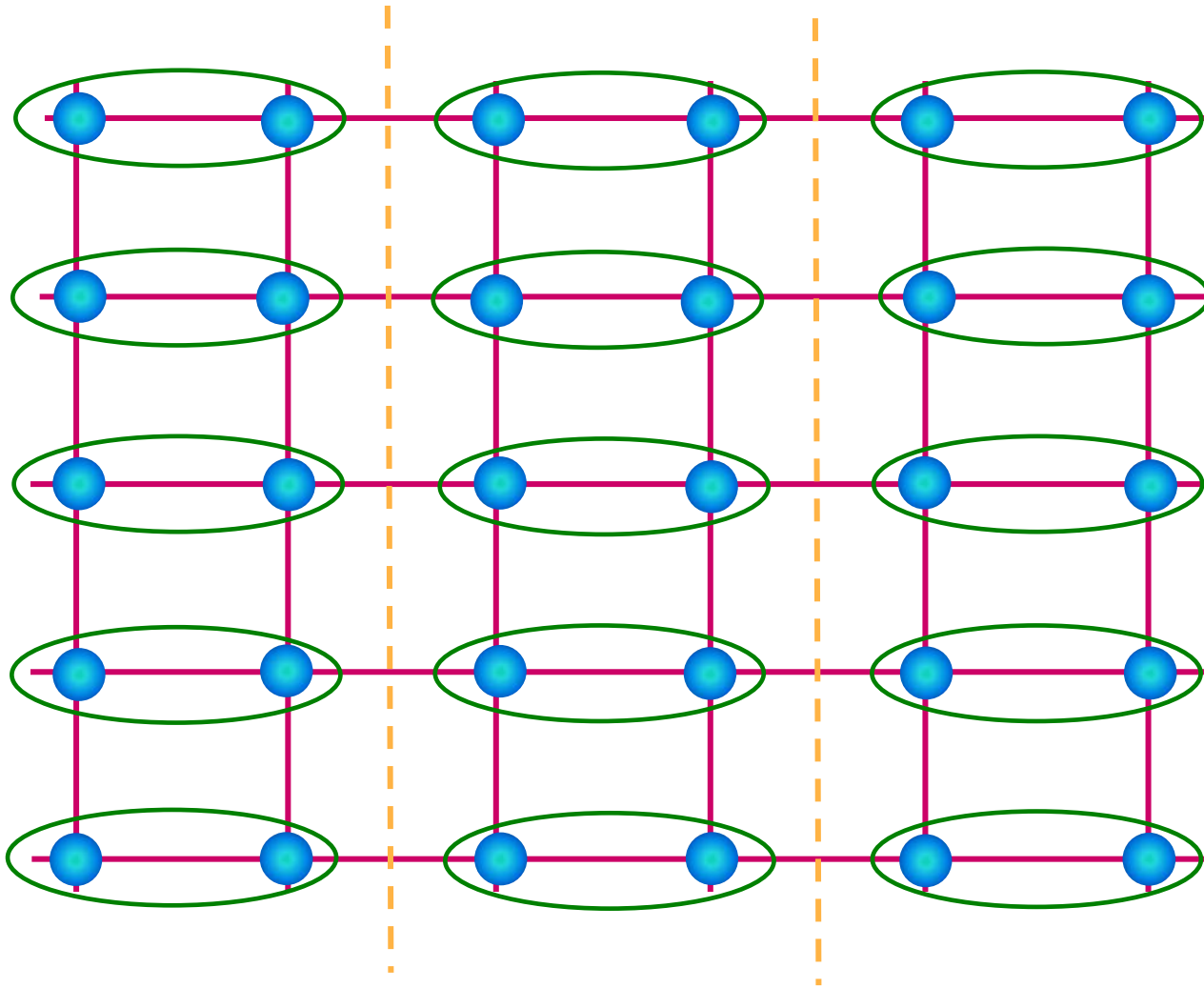

$$\text{[Green oval with two blue spheres]} = \frac{1}{\sqrt{2}} (|\uparrow\downarrow\rangle - |\downarrow\uparrow\rangle)$$

N. Read and S. Sachdev,
Phys. Rev. Lett. **62**, 1694
(1989).

R. Moessner and S. L.
Sondhi, *Phys. Rev. B* **63**,
224401 (2001).

Excitations of the RVB liquid

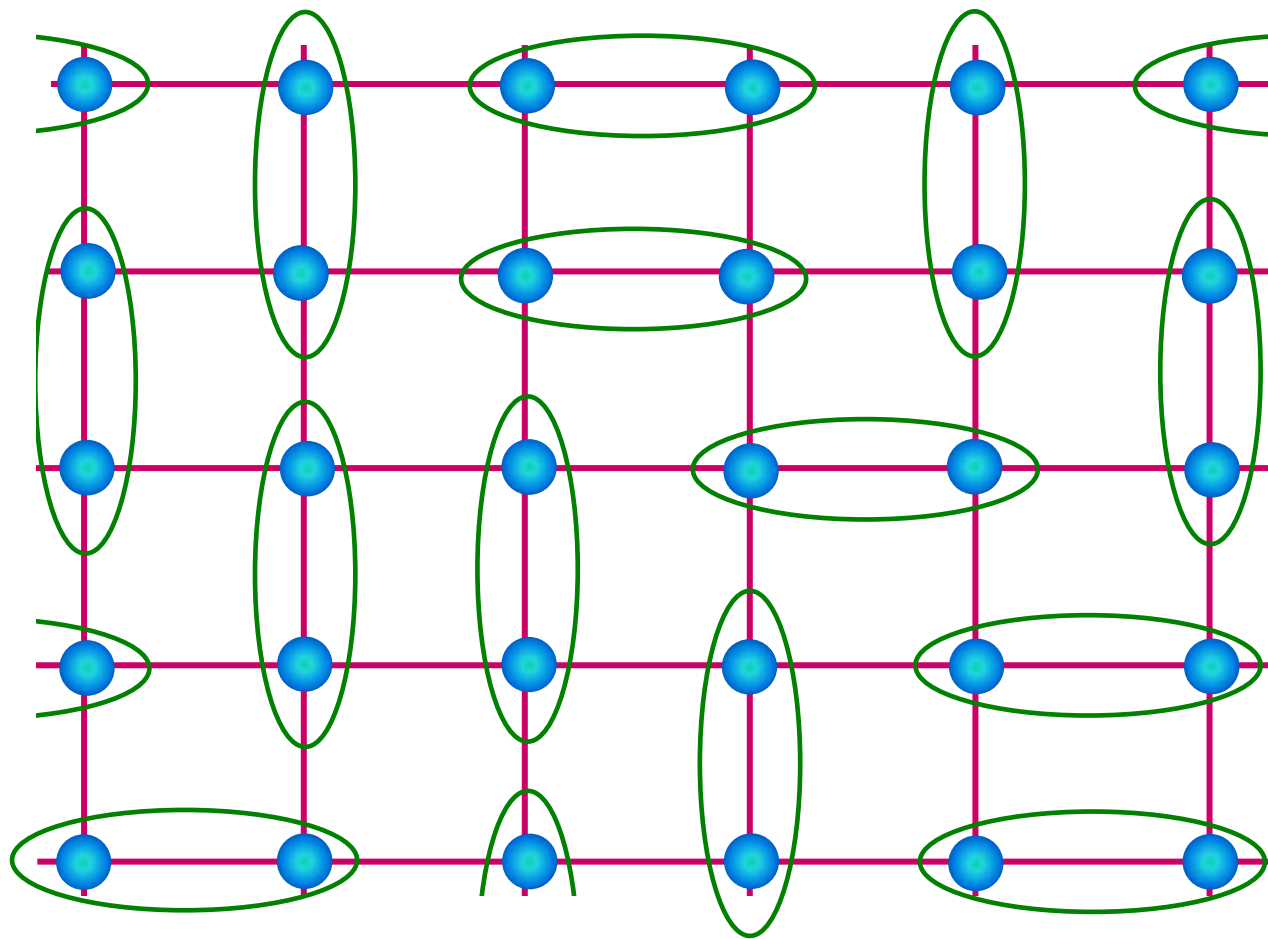

$$\text{Oval} = \frac{1}{\sqrt{2}} (|\uparrow\downarrow\rangle - |\downarrow\uparrow\rangle)$$

Excitations of the RVB liquid

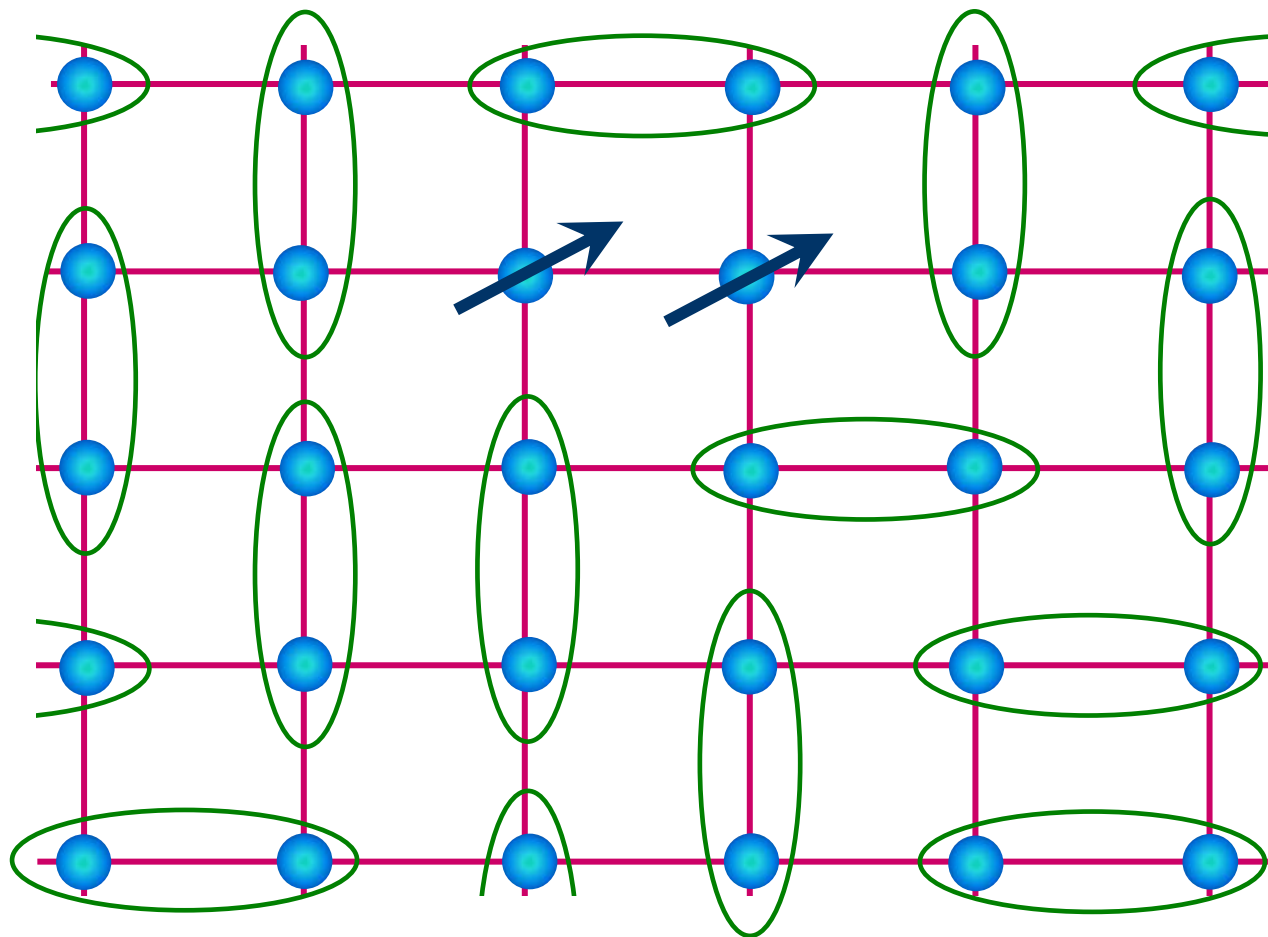

$$\text{Oval} = \frac{1}{\sqrt{2}} (|\uparrow\downarrow\rangle - |\downarrow\uparrow\rangle)$$

Excitations of the RVB liquid

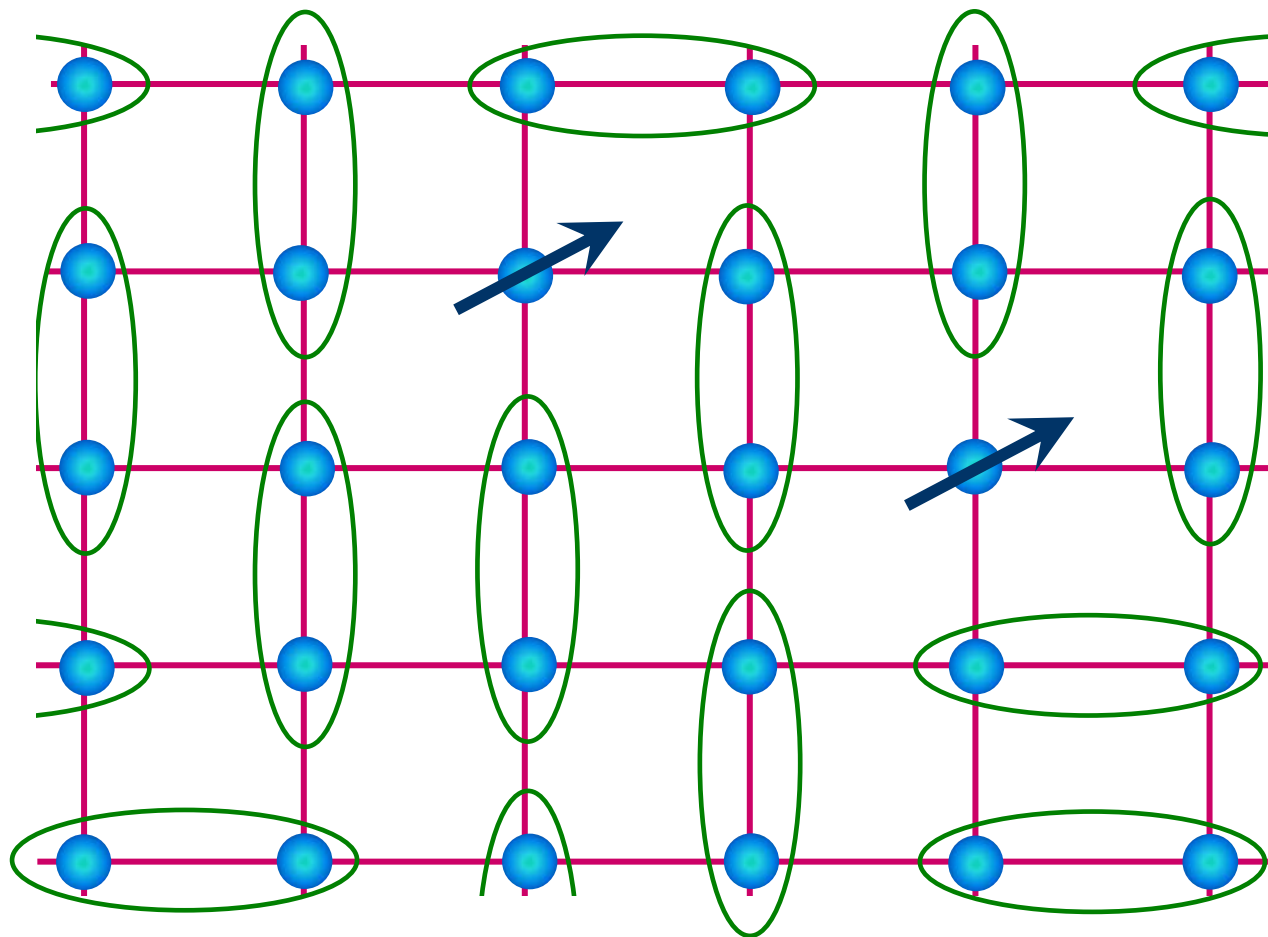

$$\text{Oval} = \frac{1}{\sqrt{2}} (|\uparrow\downarrow\rangle - |\downarrow\uparrow\rangle)$$

Excitations of the RVB liquid

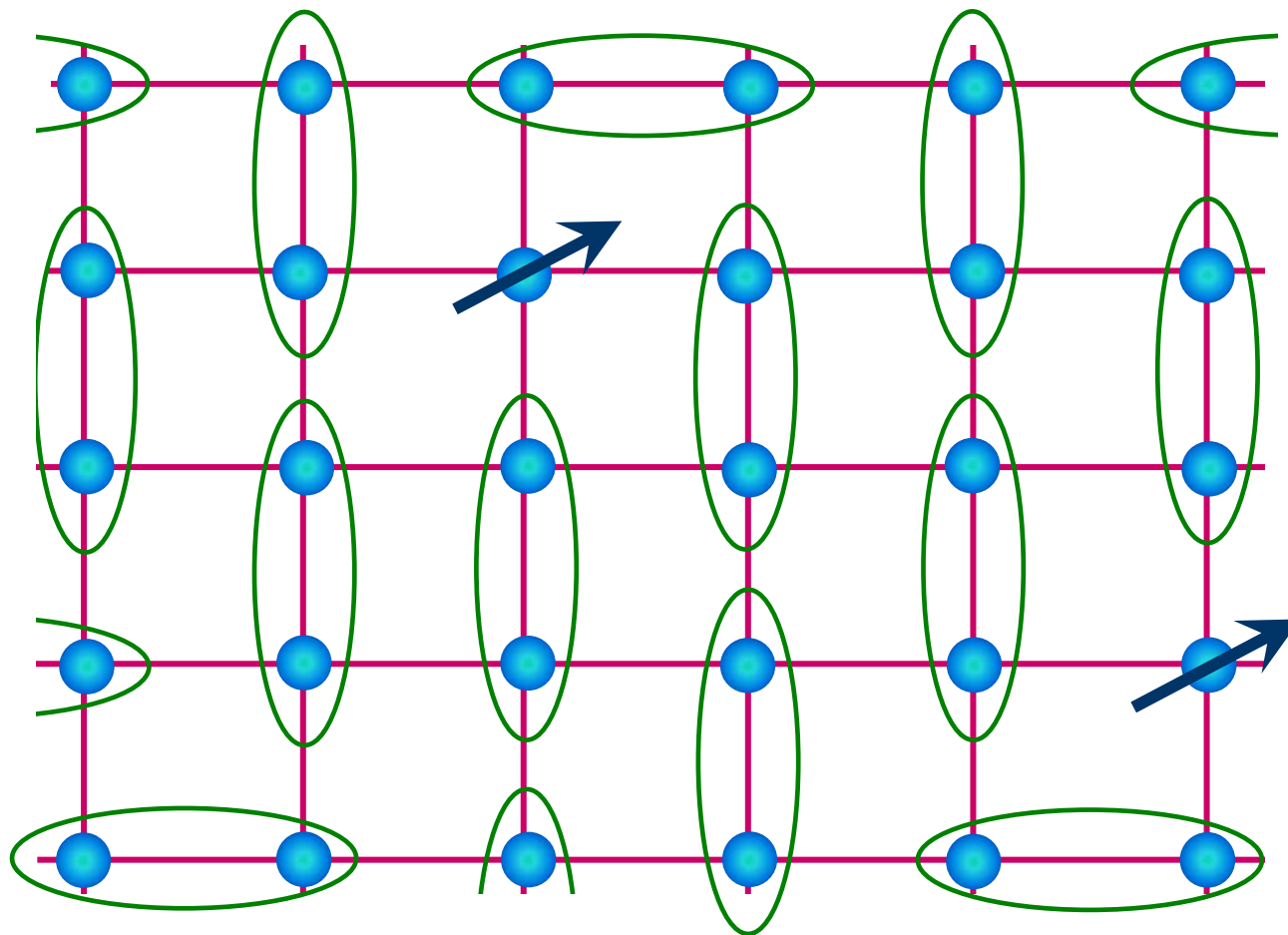

$$\text{Oval} = \frac{1}{\sqrt{2}} (|\uparrow\downarrow\rangle - |\downarrow\uparrow\rangle)$$

Excitations of the RVB liquid

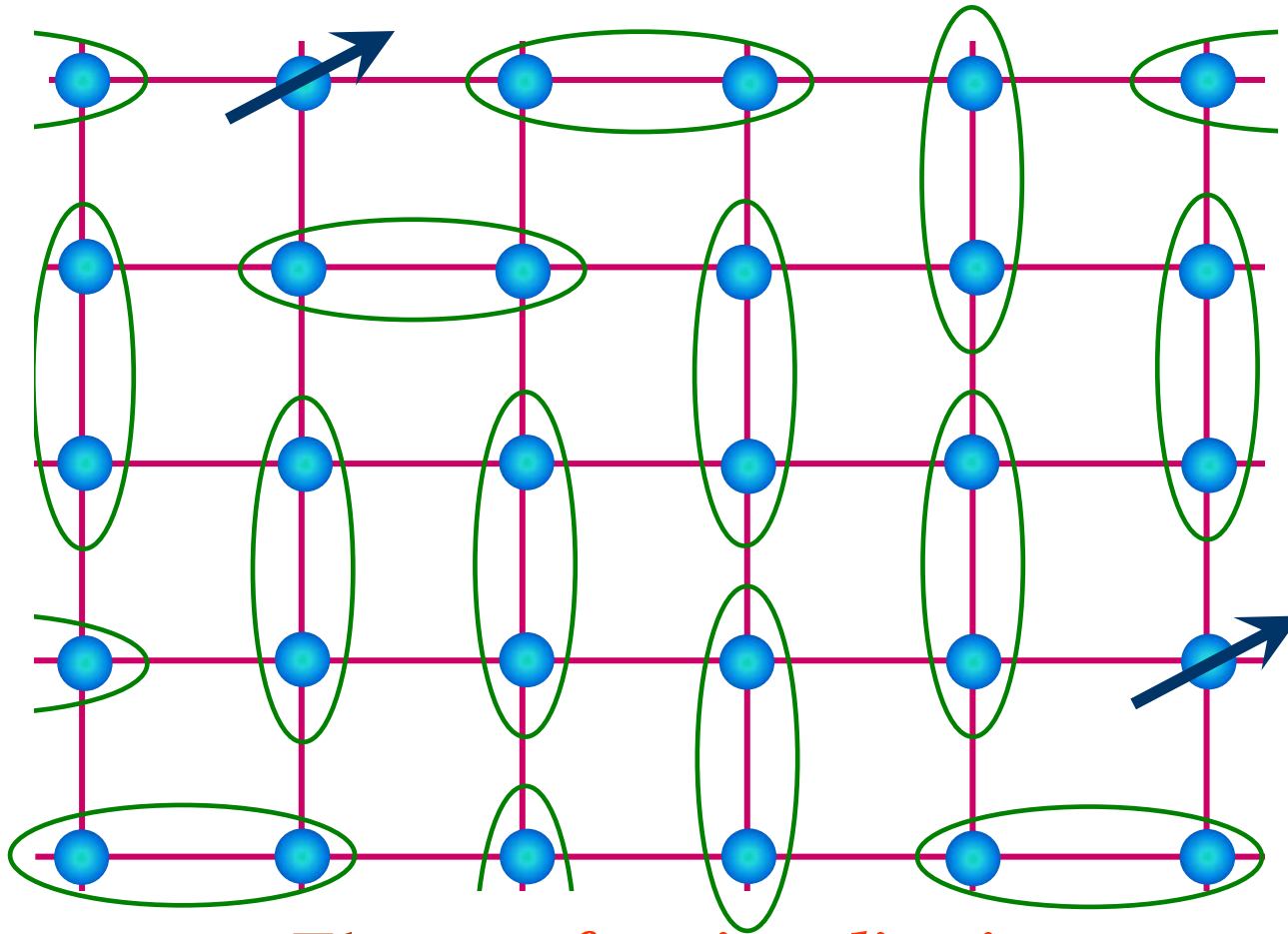

$$\text{Oval} = \frac{1}{\sqrt{2}} (|\uparrow\downarrow\rangle - |\downarrow\uparrow\rangle)$$

Electron *fractionalization*:

Excitations carry spin $S=1/2$ but no charge

Excitations of the VBS

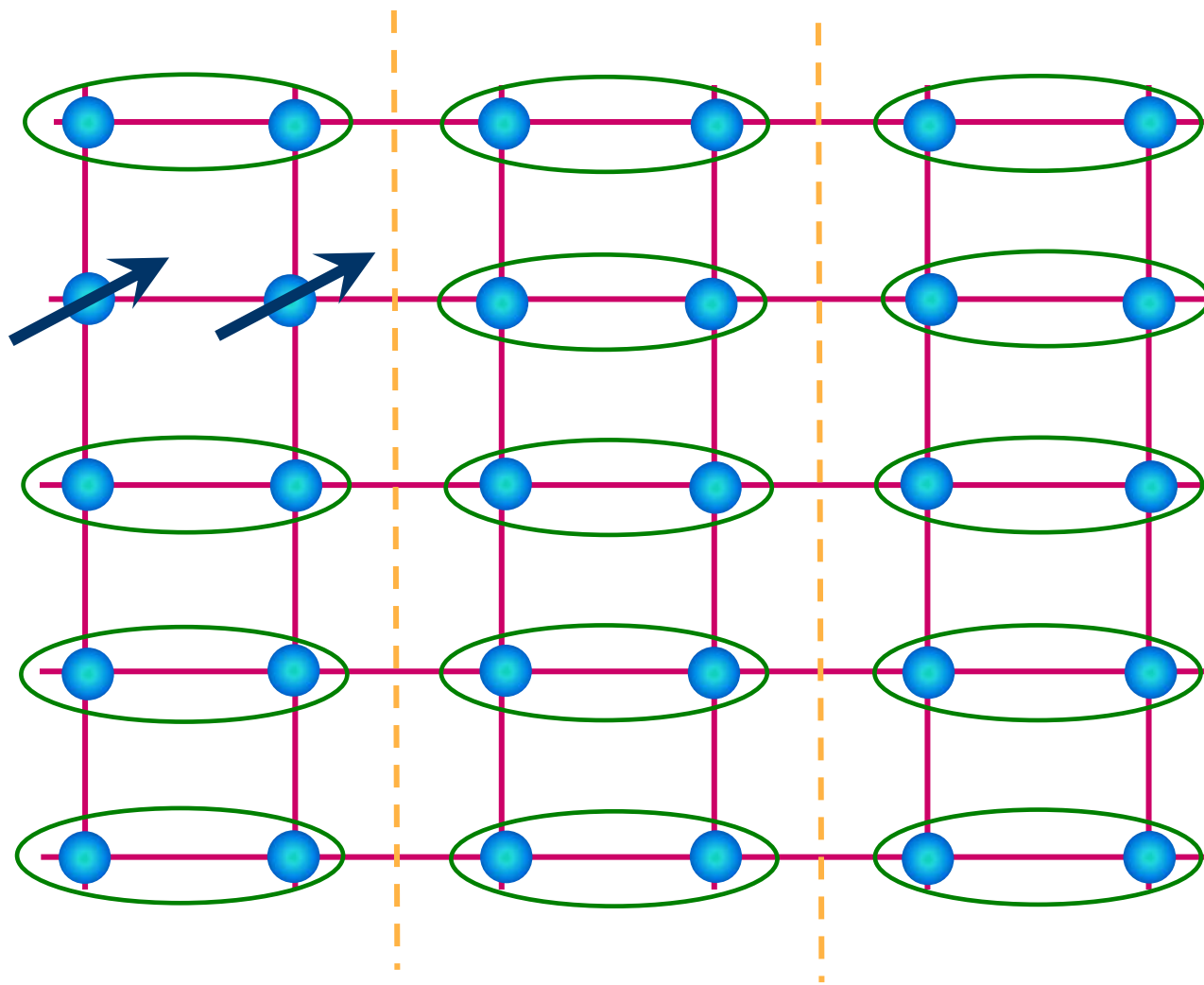

$$\text{Oval} = \frac{1}{\sqrt{2}} (|\uparrow\downarrow\rangle - |\downarrow\uparrow\rangle)$$

Excitations of the VBS

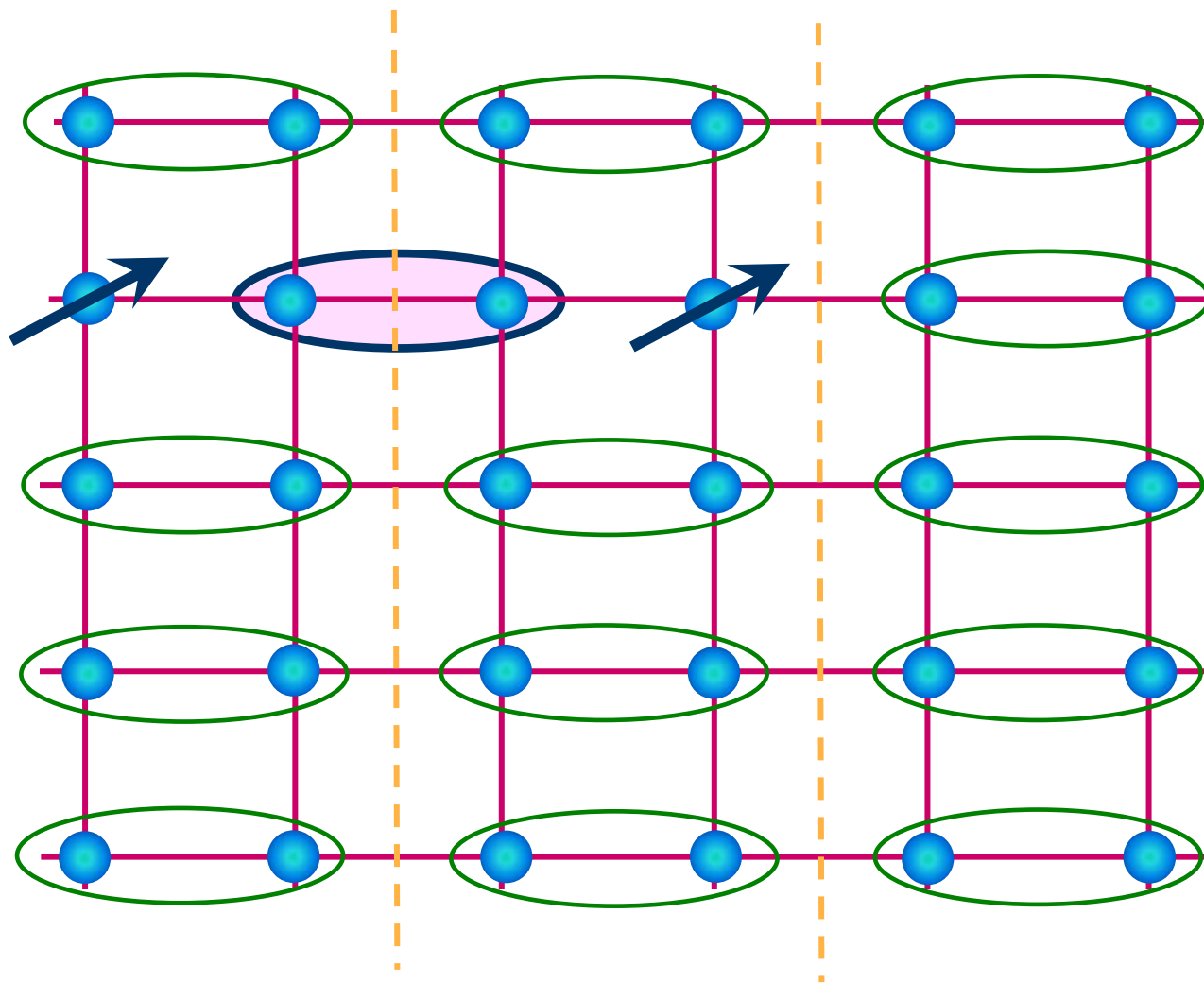

$$\text{[Diagram of two blue spheres in a green oval]} = \frac{1}{\sqrt{2}} (|\uparrow\downarrow\rangle - |\downarrow\uparrow\rangle)$$

Excitations of the VBS

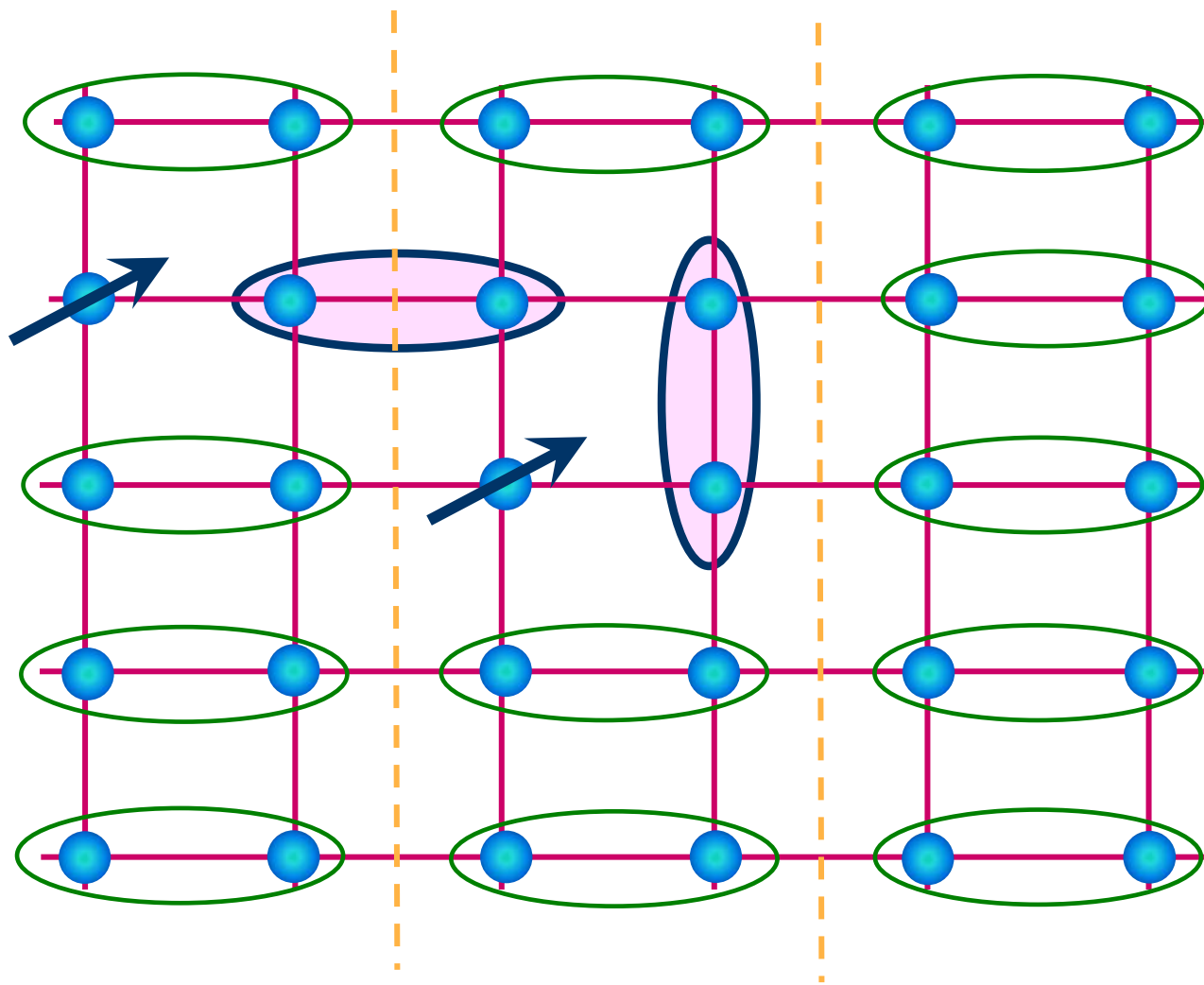

$$\text{green oval} = \frac{1}{\sqrt{2}} (|\uparrow\downarrow\rangle - |\downarrow\uparrow\rangle)$$

Excitations of the VBS

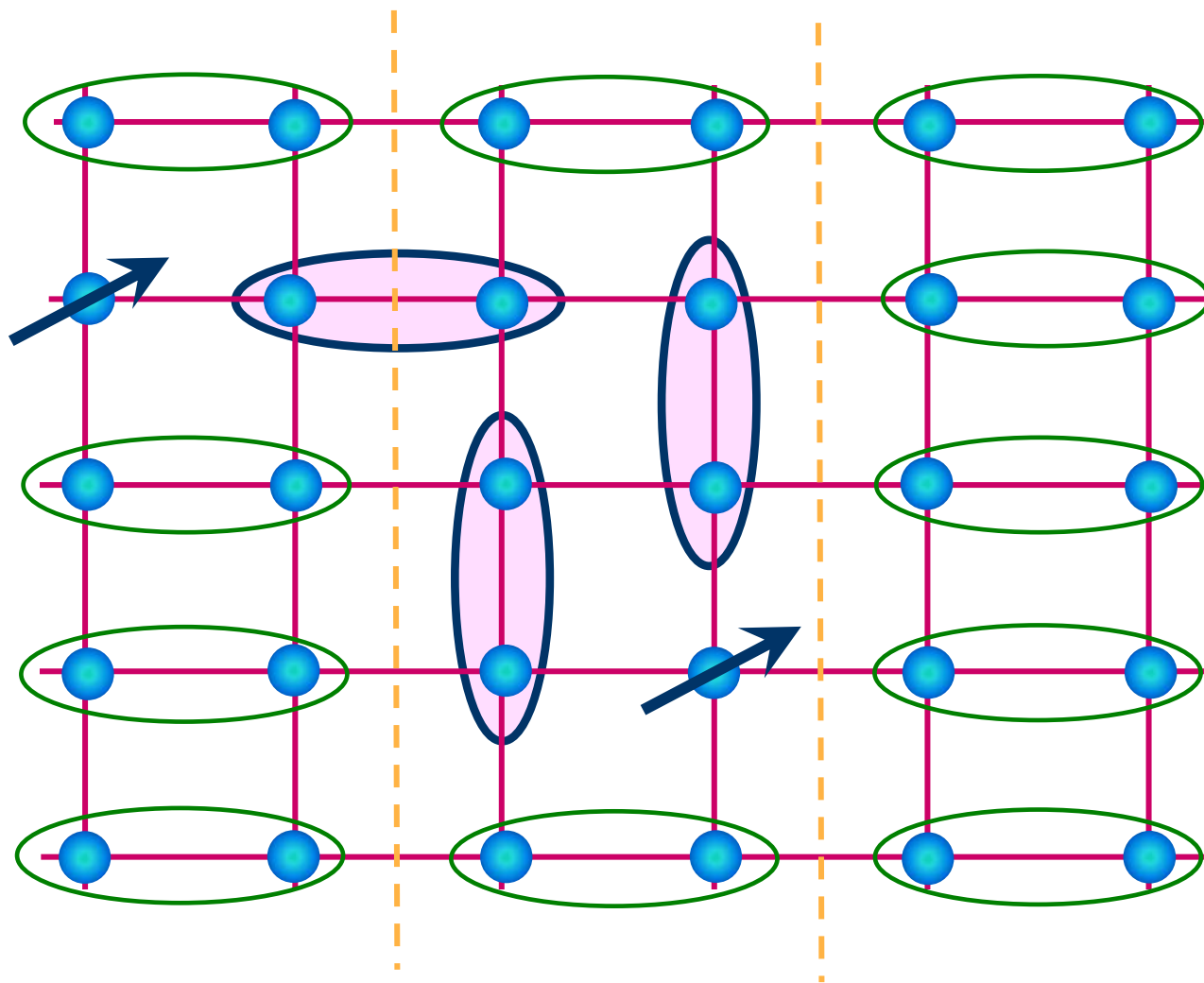

$$\text{Oval} = \frac{1}{\sqrt{2}} (|\uparrow\downarrow\rangle - |\downarrow\uparrow\rangle)$$

Excitations of the VBS

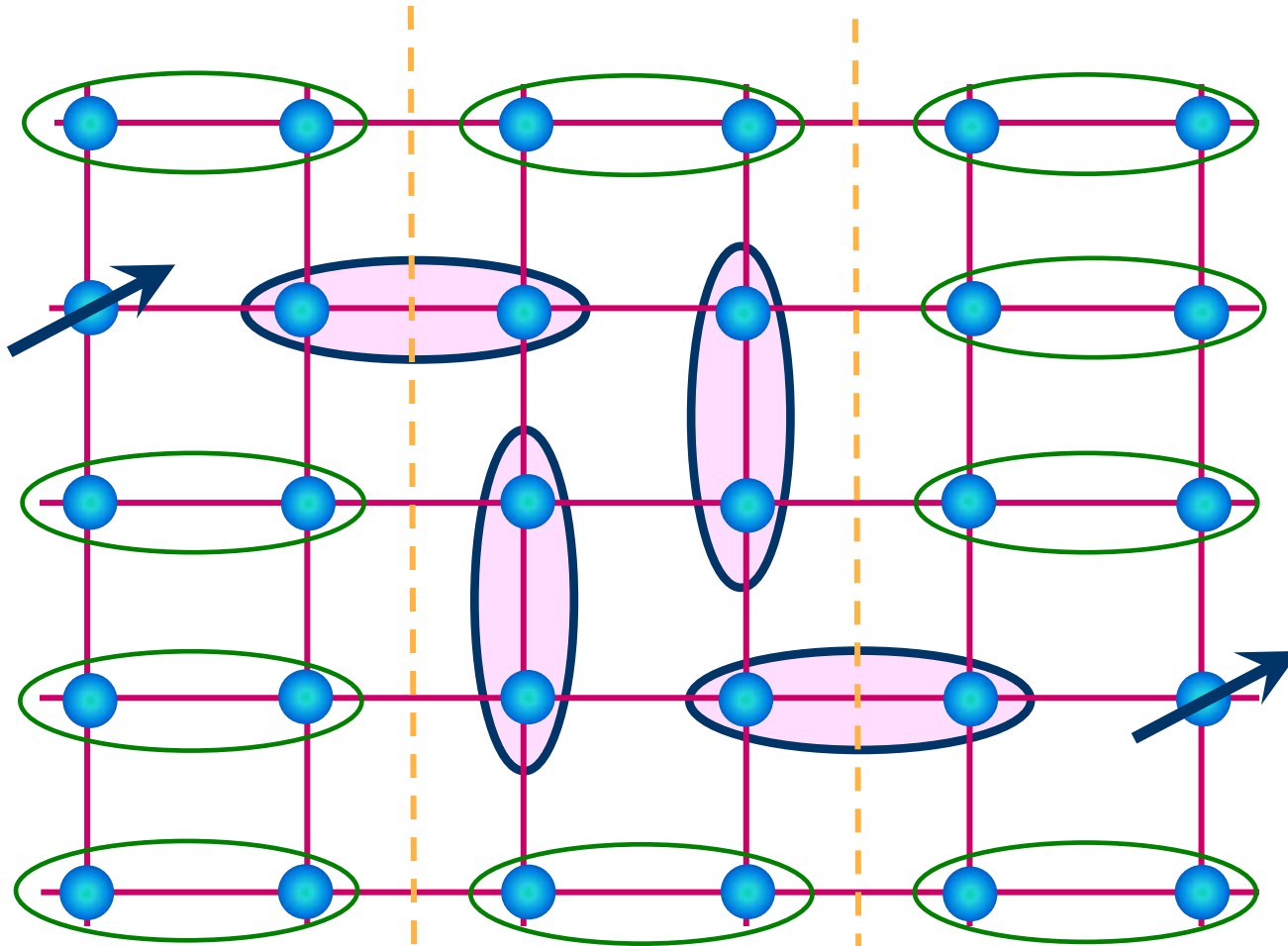

$$\text{Oval with two blue spheres} = \frac{1}{\sqrt{2}} (|\uparrow\downarrow\rangle - |\downarrow\uparrow\rangle)$$

Free spins are unable to move apart:
no fractionalization, but *confinement*

Phase diagram of square lattice antiferromagnet

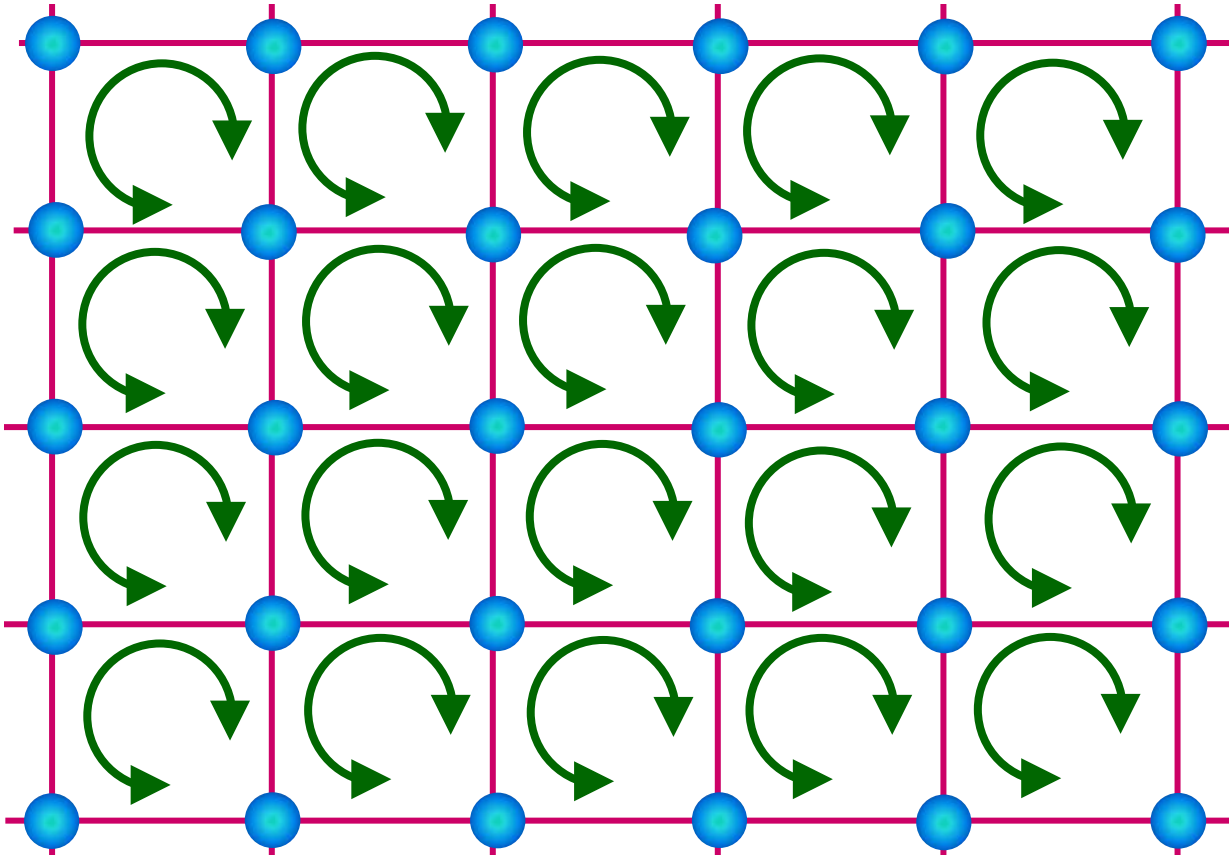

$$H = J \sum_{\langle ij \rangle} \vec{S}_i \cdot \vec{S}_j + K \sum_{\square} \text{4-spin exchange}$$

Phase diagram of square lattice antiferromagnet

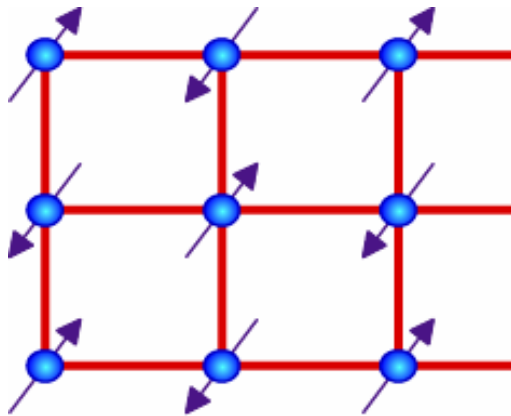

Neel order

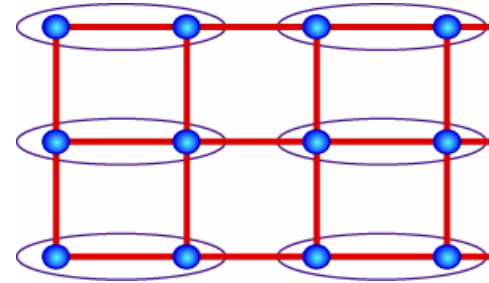

VBS order

K/J

$$H = J \sum_{\langle ij \rangle} \vec{S}_i \cdot \vec{S}_j + K \sum_{\square} 4\text{-spin exchange}$$

Phase diagram of square lattice antiferromagnet

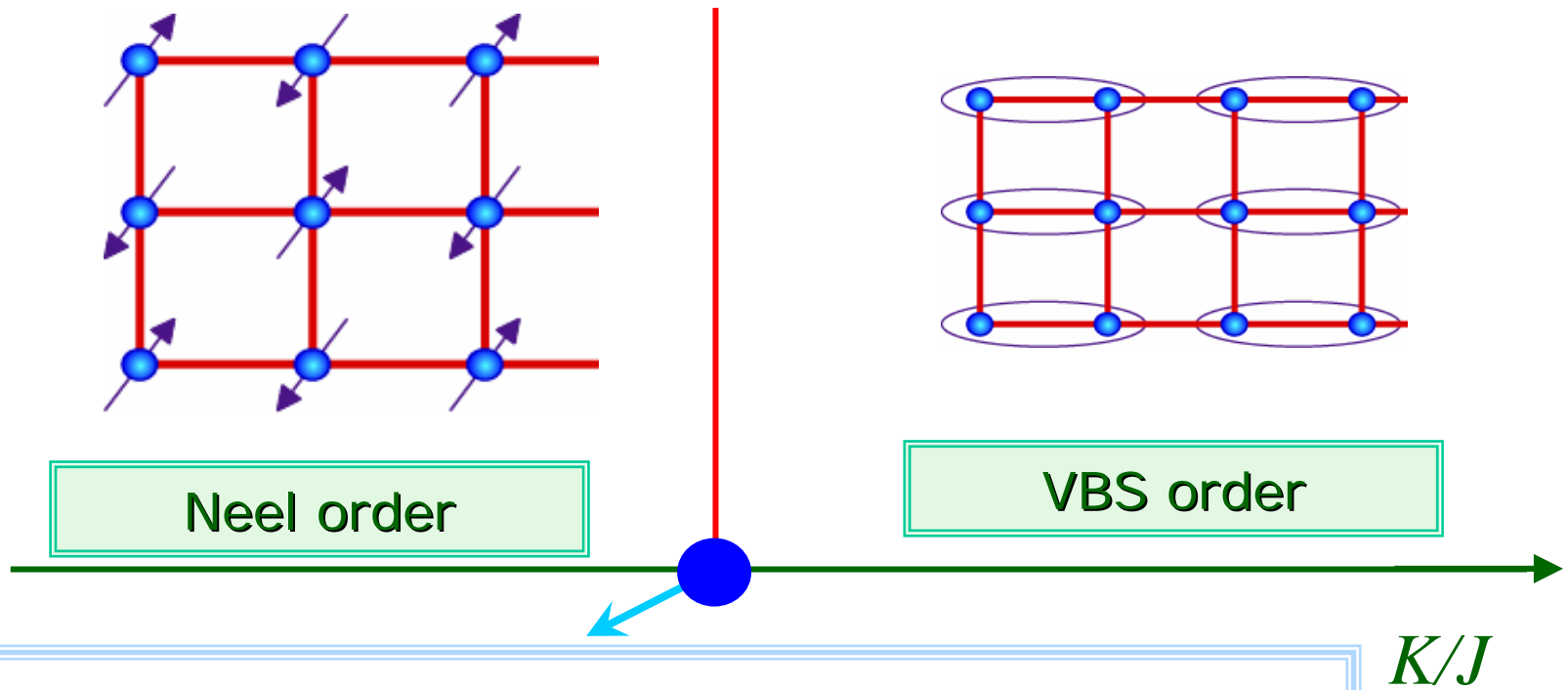

RVB physics appears at the quantum critical point which has fractionalized excitations: “deconfined criticality”

$$H = J \sum_{\langle ij \rangle} \vec{S}_i \cdot \vec{S}_j + K \sum_{\square} 4\text{-spin exchange}$$

Temperature, T

Quantum criticality of
fractionalized
excitations

0

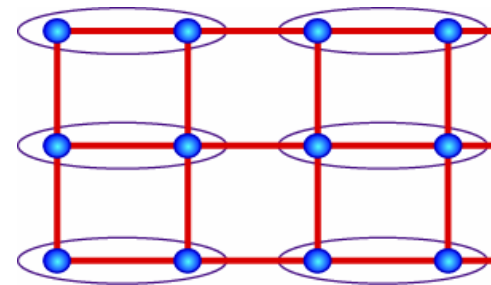
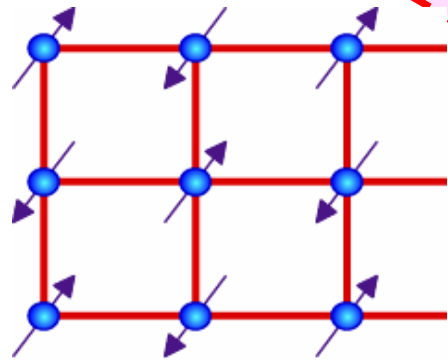

K/J

Phases of nuclear matter

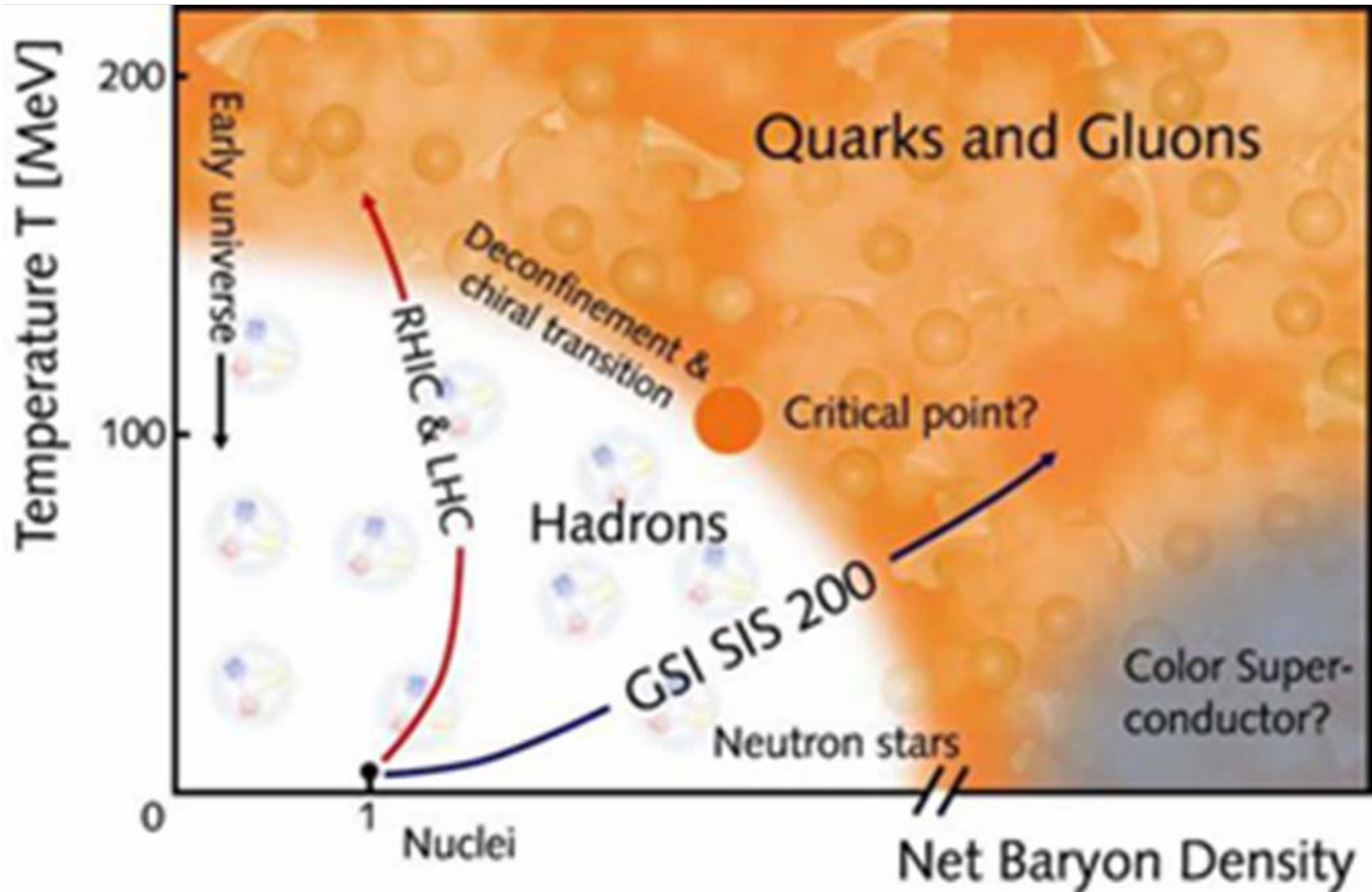

Conclusions

- Rapid progress in the understanding of quantum liquids near unitarity
- Rich possibilities of exotic quantum phases in optical lattices
- Cold atom studies of the entanglement of large numbers of qubits: insights may be important for quantum cryptography and quantum computing.
- Tabletop “laboratories for the entire universe”: quantum mechanics of black holes, quark-gluon plasma, neutrons stars, and big-bang physics.

