

I. What controls viral size?

II. Reconstituting an animal virus

Two not totally unrelated topics

GELBART-KNOBLER GROUP

Odisse Azizgolshani

Li Tai Fang

Aron Yoffe

Ajay Gopal

Yufang Hu

Adriana Anavitarte

Mauricio Comas

Serge Dmitrieff

Connie Chang (Tom Mason)

COLLABORATORS

Laurence Lavelle (UCLA)

A. L. N. Rao (UCR)

Jim & Ellen Strauss (Caltech)

Marlene Biller (Caltech)

WHAT DETERMINES THE SIZE OF A VIRUS?

WHAT IS THE RELATIONSHIP BETWEEN
CAPSID SIZE AND GENOME SIZE?

(1) ***WHAT DETERMINES THE SIZE OF A CAPSID?***

(2) “ “ “ ***OF A GENOME?***
PHYSICAL 

QUESTION (1)  ***SELF-ASSEMBLY OF
PROTEINS IN 2D CURVED SPACE***

QUESTION (2)  ***CONFIGURATIONAL
STATISTICS OF DNA AND RNA***

GENOME SIZE PLAYS A ROLE...

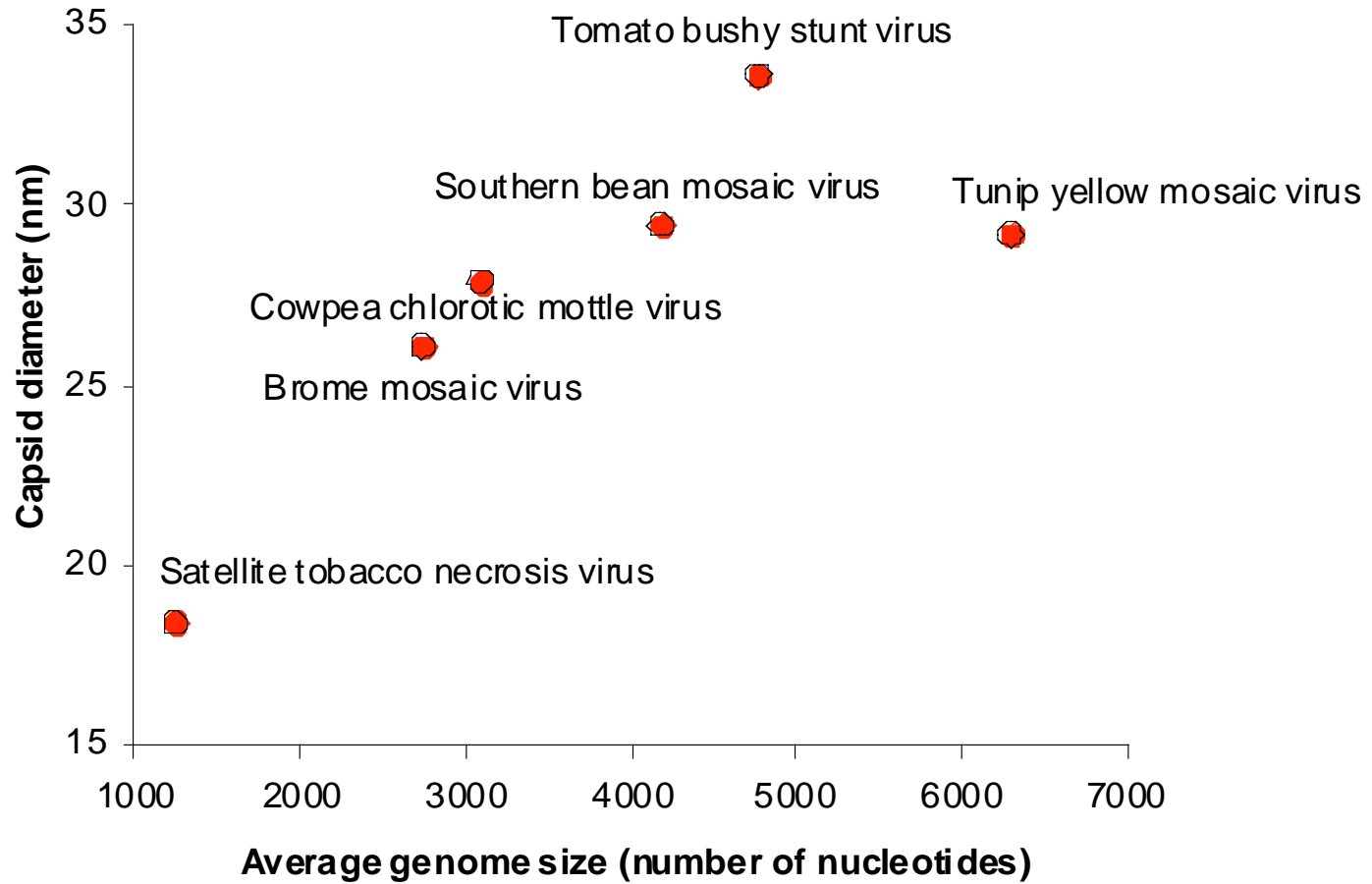

BUT...

Tobacco Mosaic Virus (TMV)

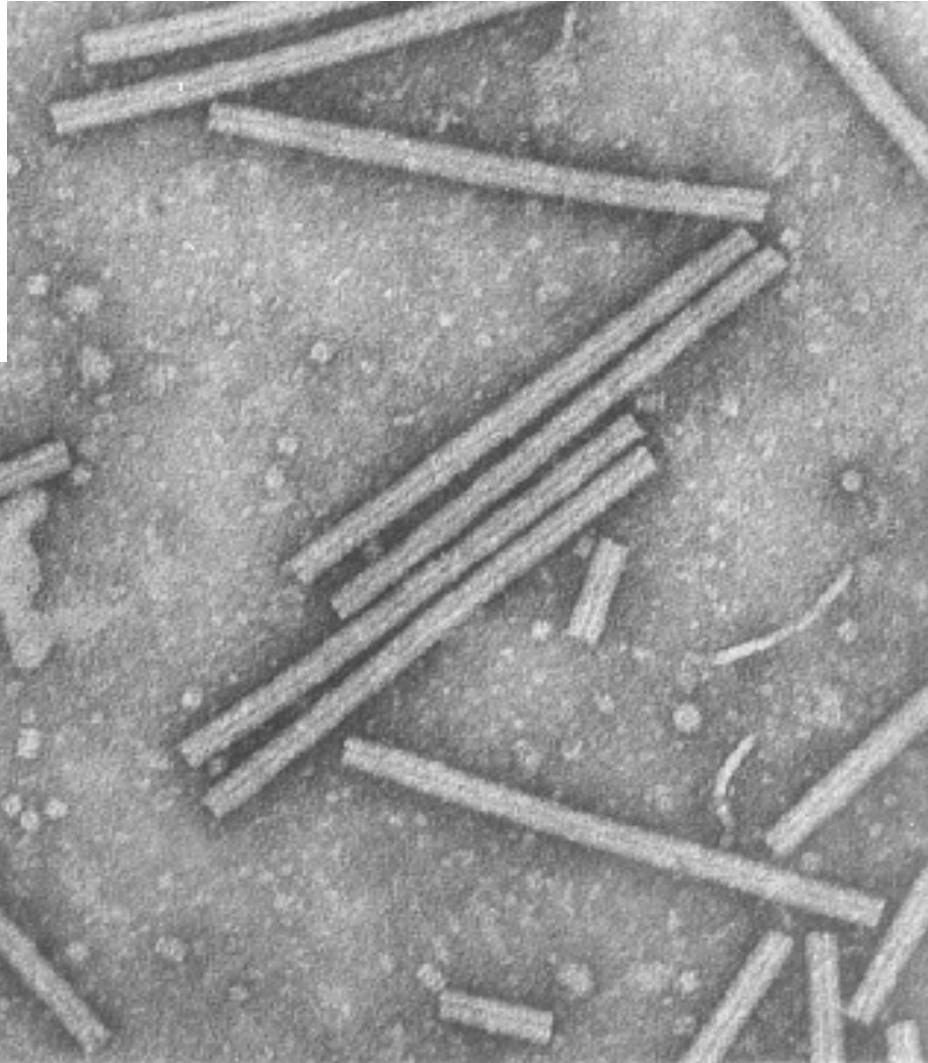
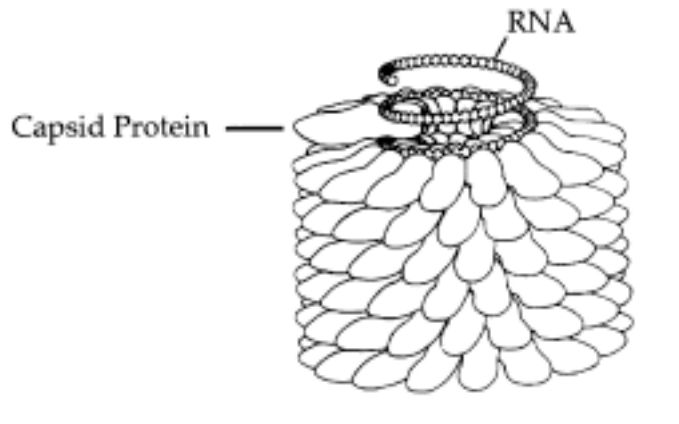

**RNA
6395nt
long**

**RNA 6318
nt long**

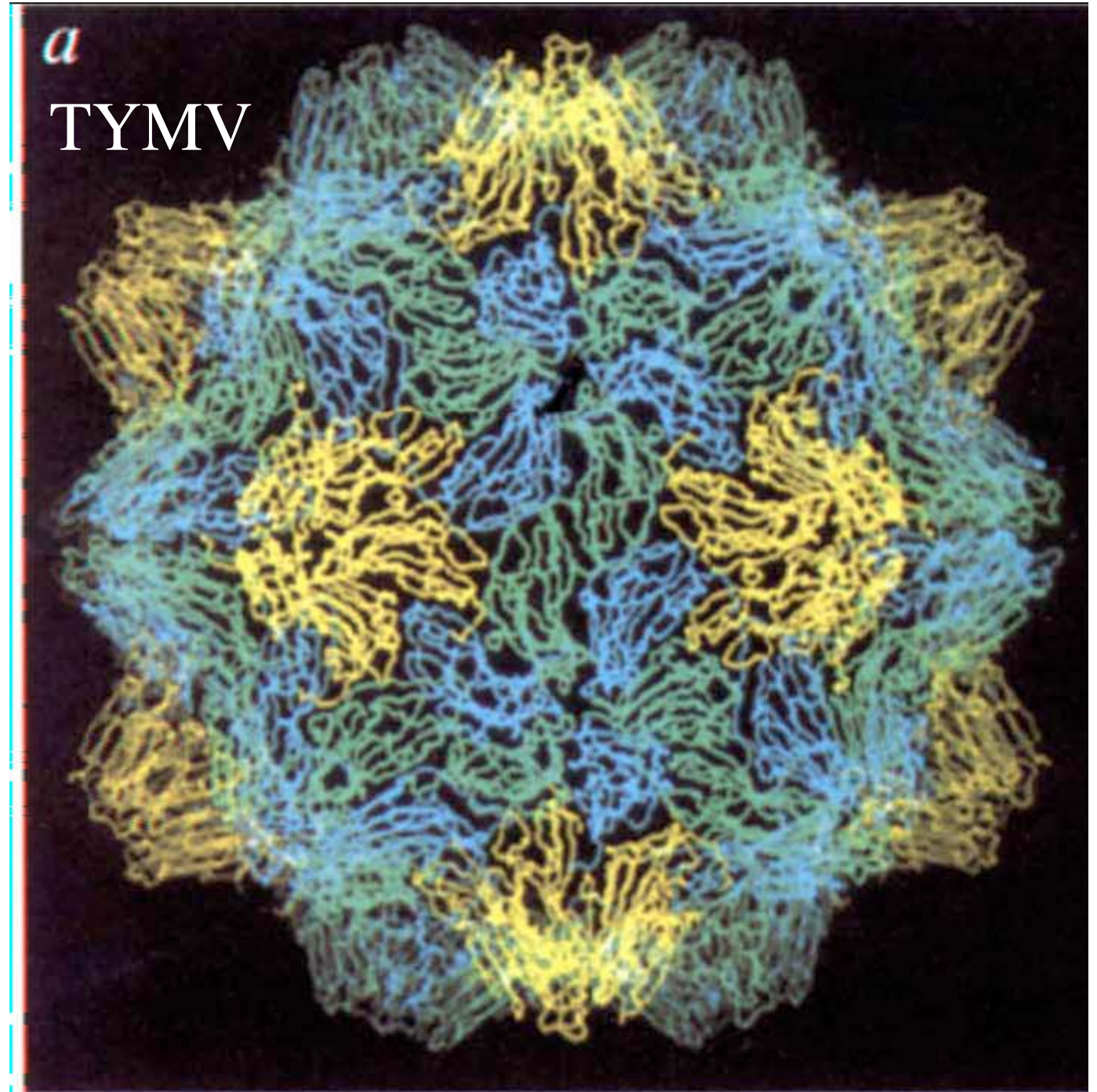

THE CAPSID PROTEIN AND
ITS SPONTANEOUS
CURVATURE MUST PLAY A
ROLE

In the absence of RNA, CCMV capsid protein has many polymorphs

- Capsid protein can assemble into different structures
 - Icosahedral
 - Tubular
 - Planar hexagonal
 - Multishell

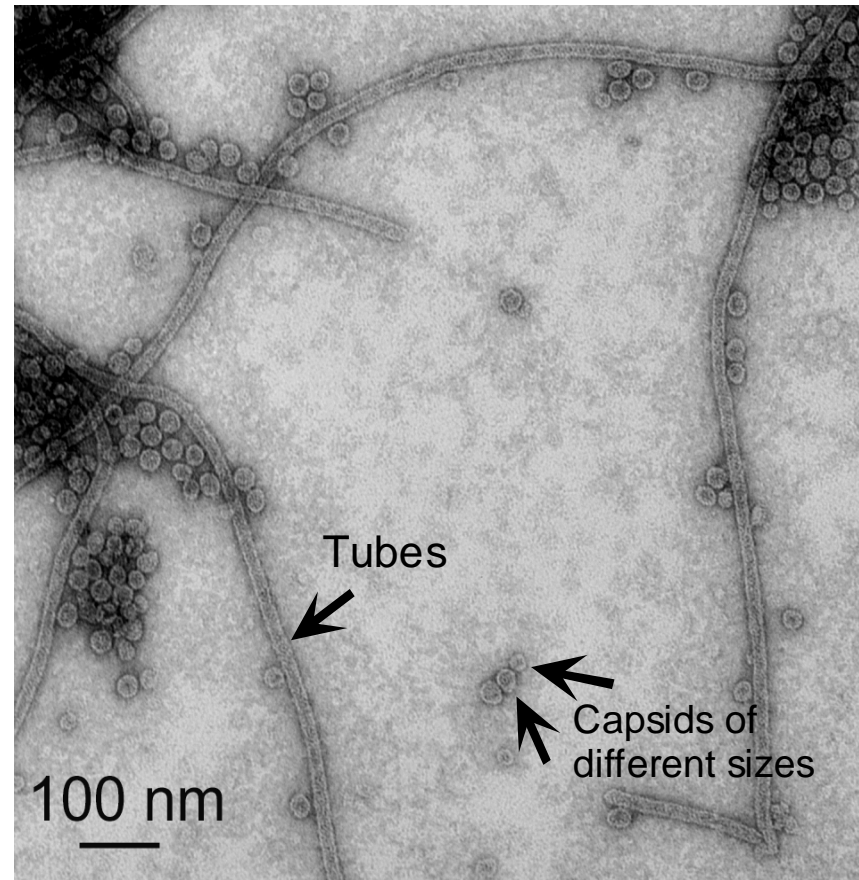

PACKAGING EXPERIMENTS

- Materials

- Purified CCMV capsid protein
- Sodium polystyrene sulfonate (PSS)

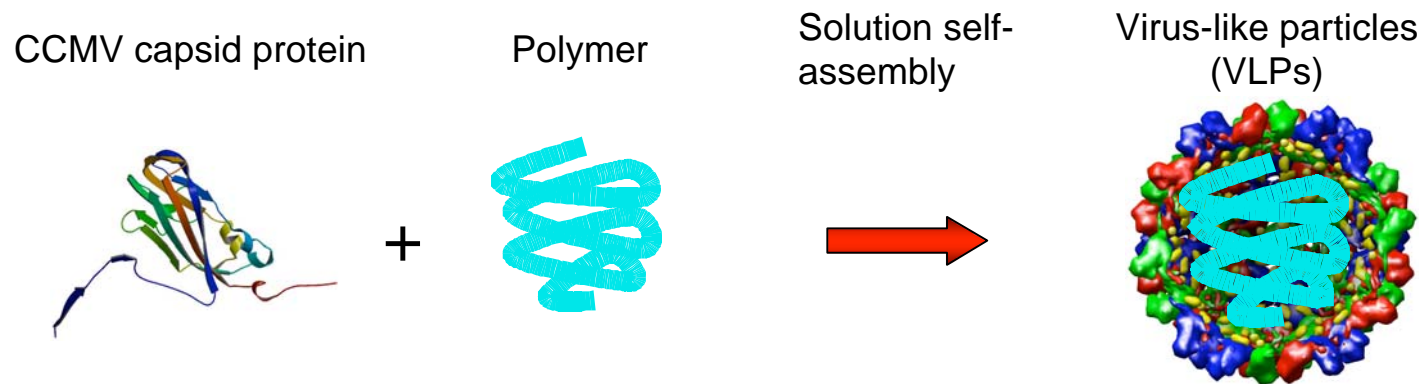

- Techniques

- Negative staining transmission electron microscopy (TEM)
- Analytical ultracentrifugation

Properties of PSS

- Highly negatively charged (>95%), flexible polymer
- Linear charge density is $\sim 1e/3\text{\AA}$, comparable to RNA
- Wide range of molecular weights available:
400 k, 700 k, 1 M, 2 M, 3.4 MDa

Hydrodynamic radius of PSS

Laser light scattering

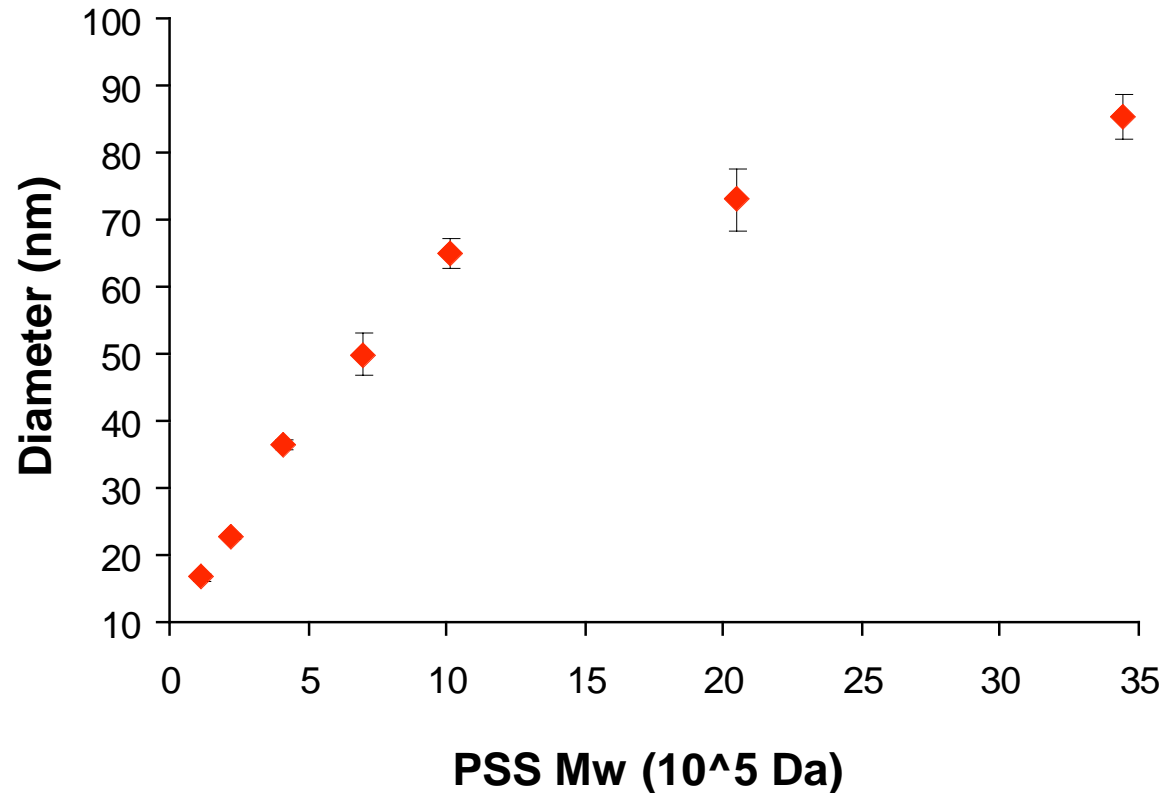

Assembly buffer: 50 mM NaCl, 50 mM Tris-HCl, pH 7.2, 10 mM KCl, 5 mM MgCl₂

Hydrodynamic Radius of PSS

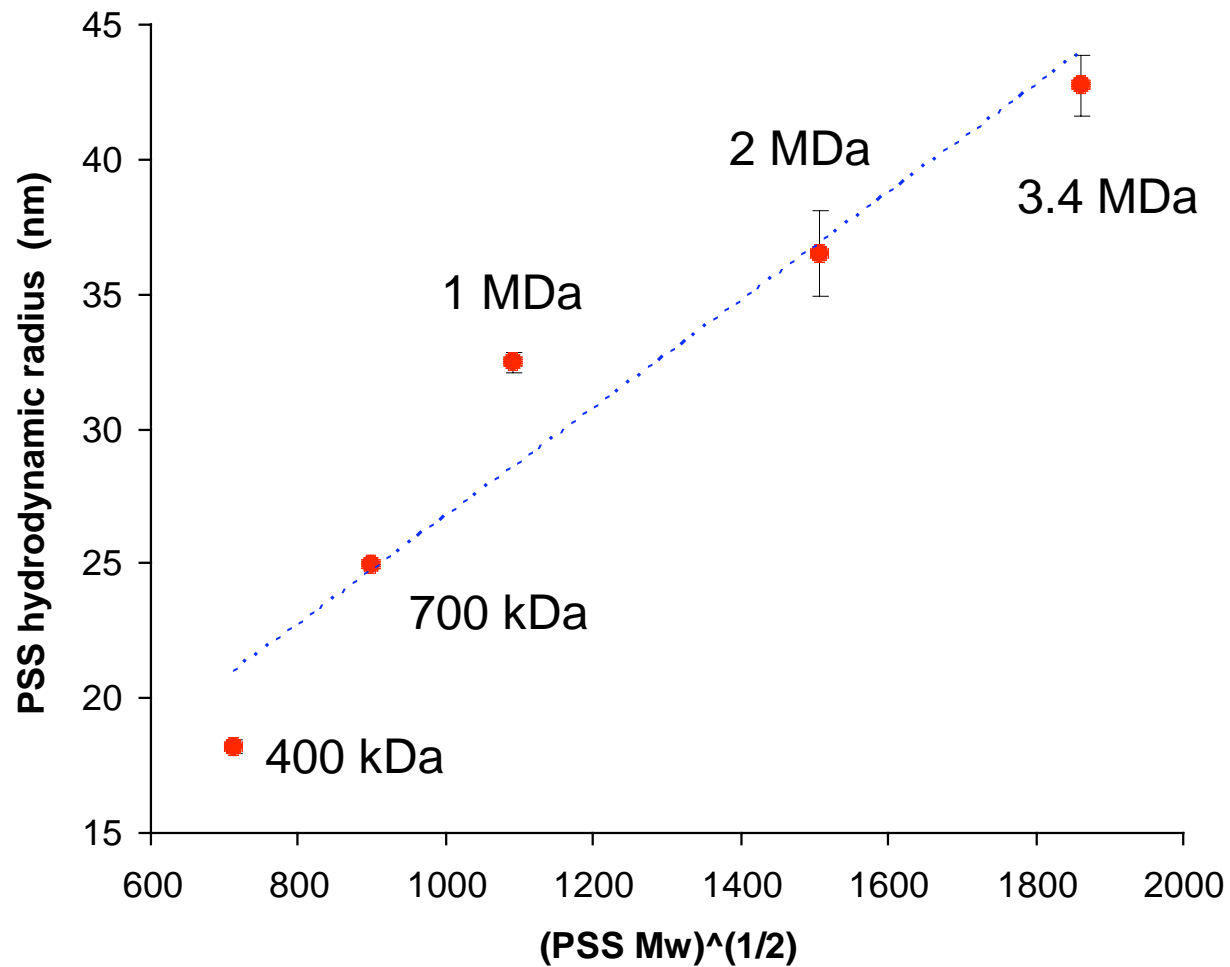

Assembly buffer: 50 mM NaCl, 50 mM Tris-HCl, pH 7.2, 10 mM KCl, 5 mM MgCl₂

Negative Staining TEM

- Presence of sample excludes stain
- Contrast is provided by stain
- Direct visualization of VLP structure
- Sample is dehydrated - so dimensions differ from those in solution

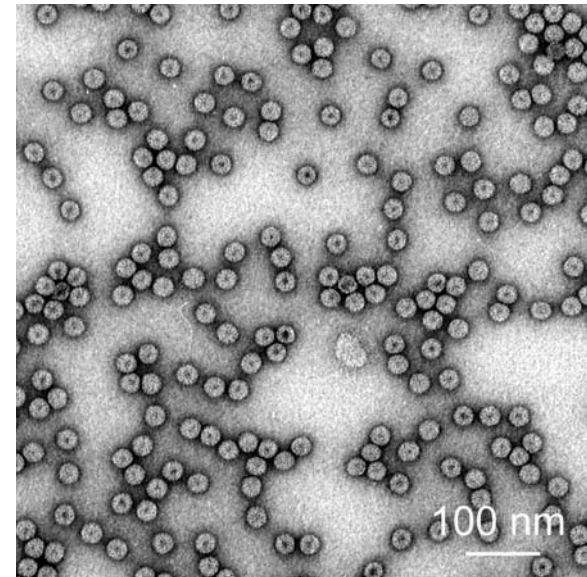
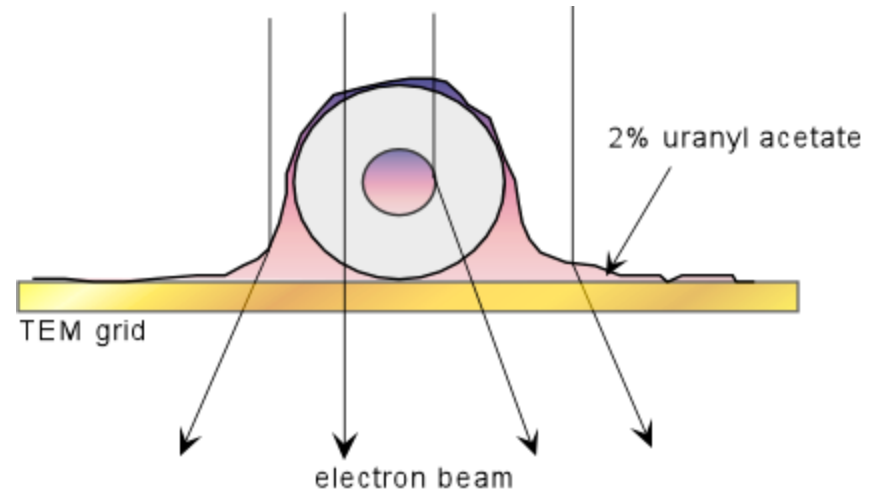

VLPs Formed in Assembly Reactions

VLP 700k

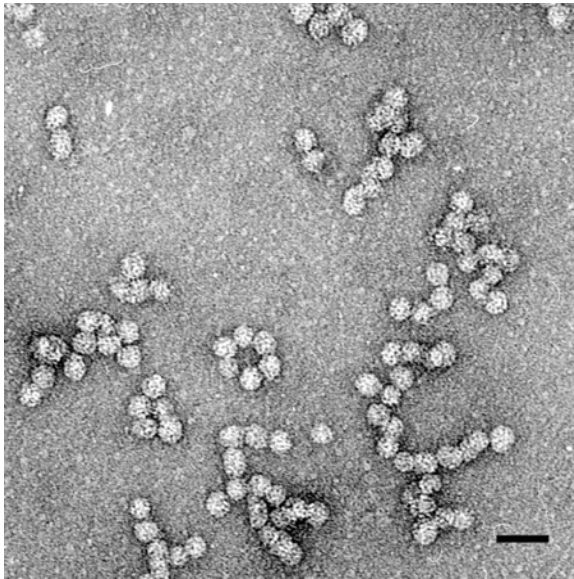

VLP 2M

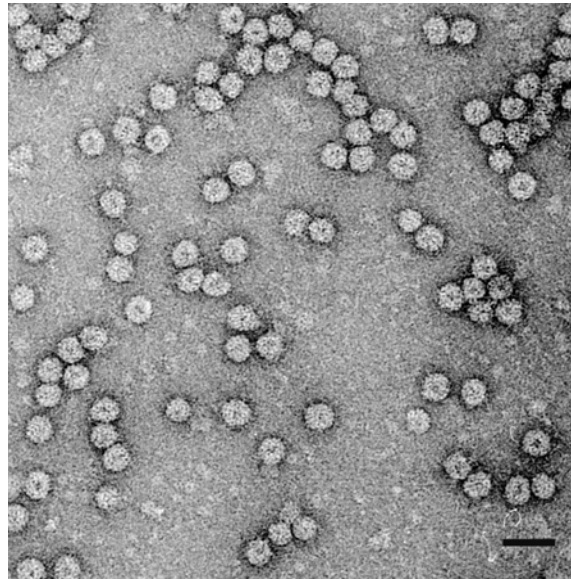

wt CCMV

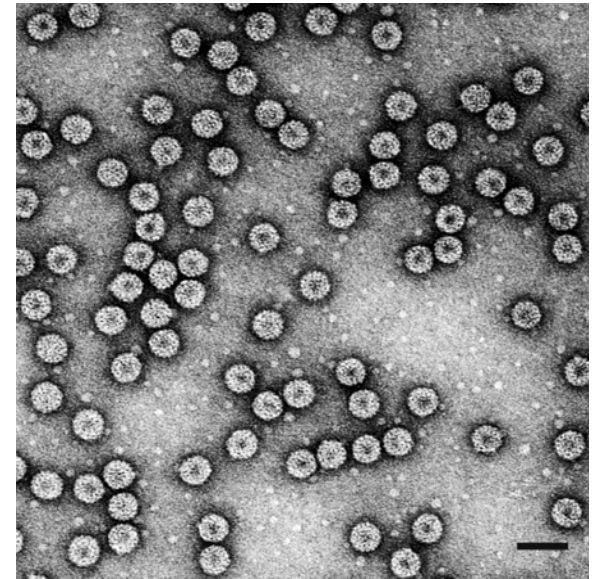

Scale bars are 50 nm

Morphology of VLPs

VLP 1 MDa

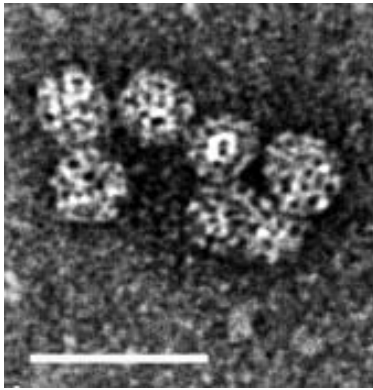

Protein only, no PSS

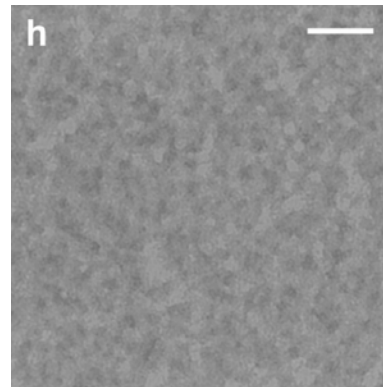

Empty capsid

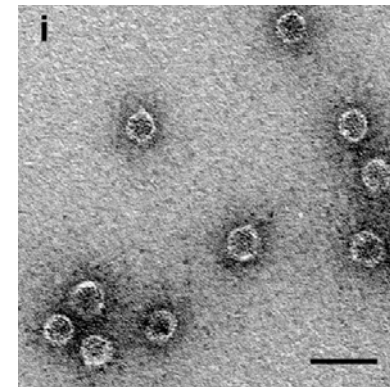

Scale bars are 50 nm

- No stain penetration into interior of VLPs
- Interior of VLPs are filled with material
- VLP formed via encapsidation of PSS

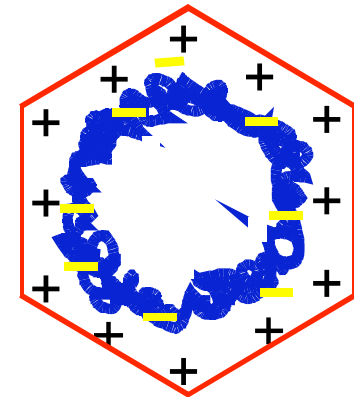

Sizing the VLPs

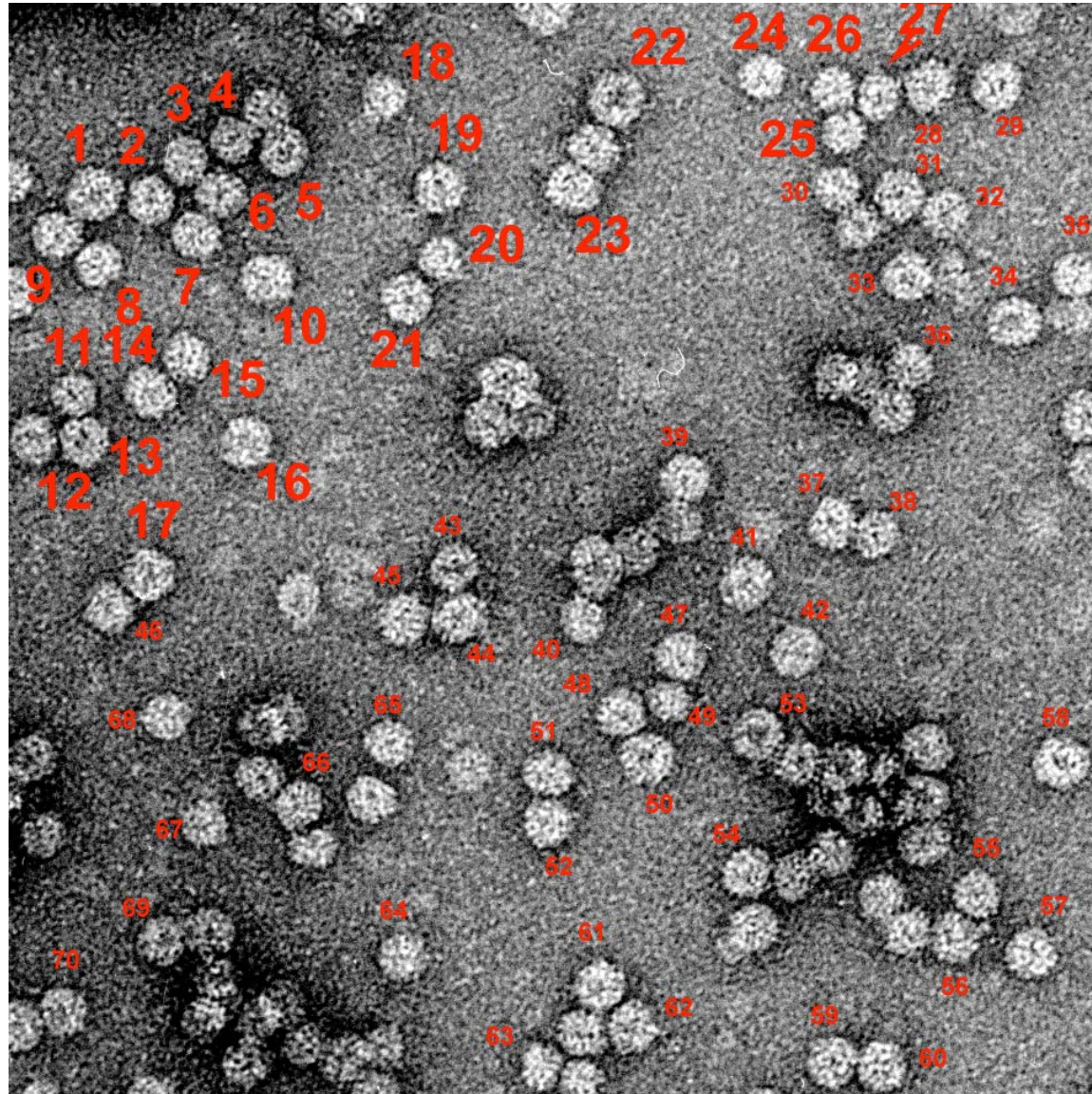

Capsid Size Distribution

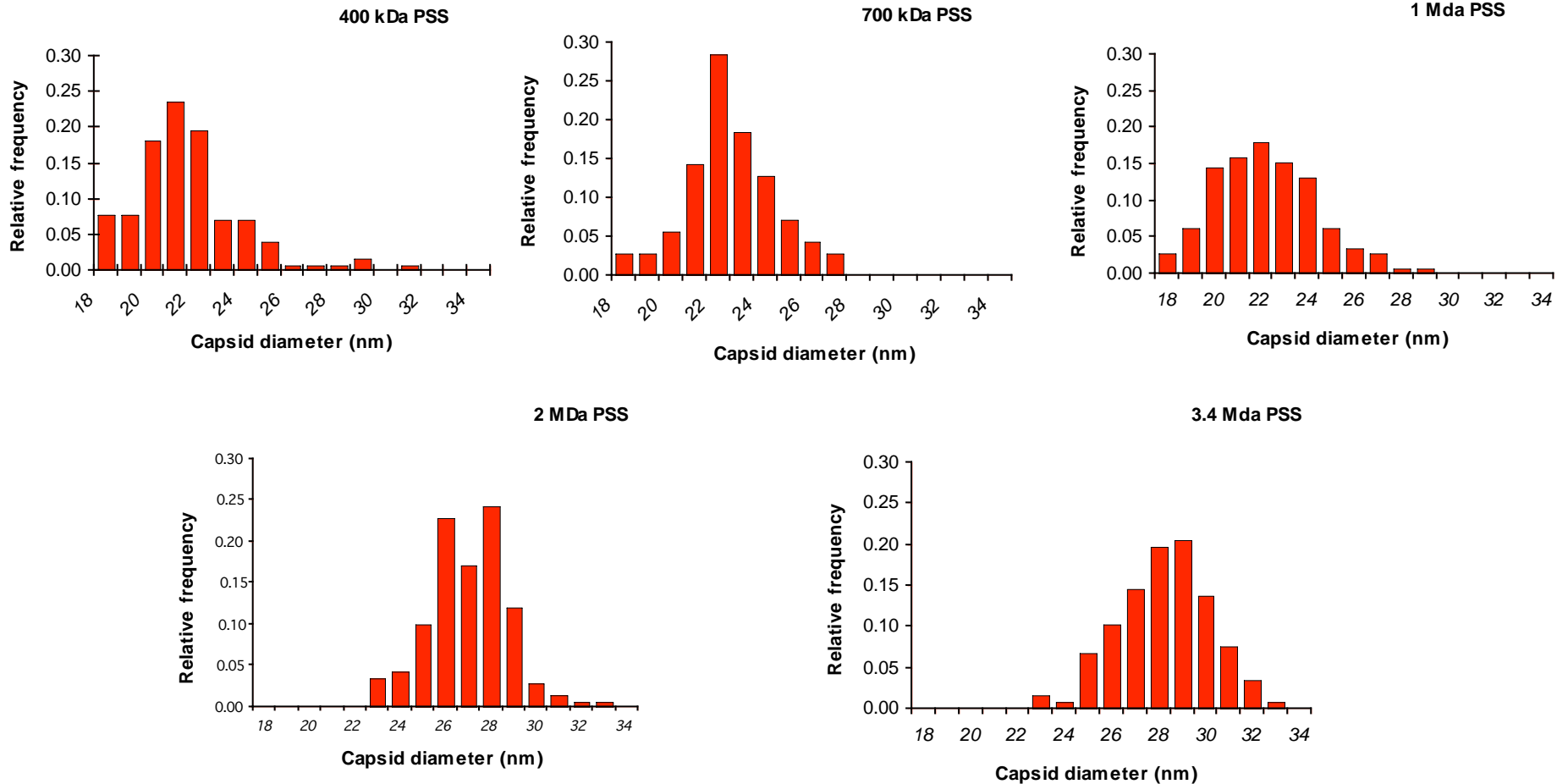

Capsid size converges to two discrete values: 22, 27nm

The Capsid Sizes are Discrete

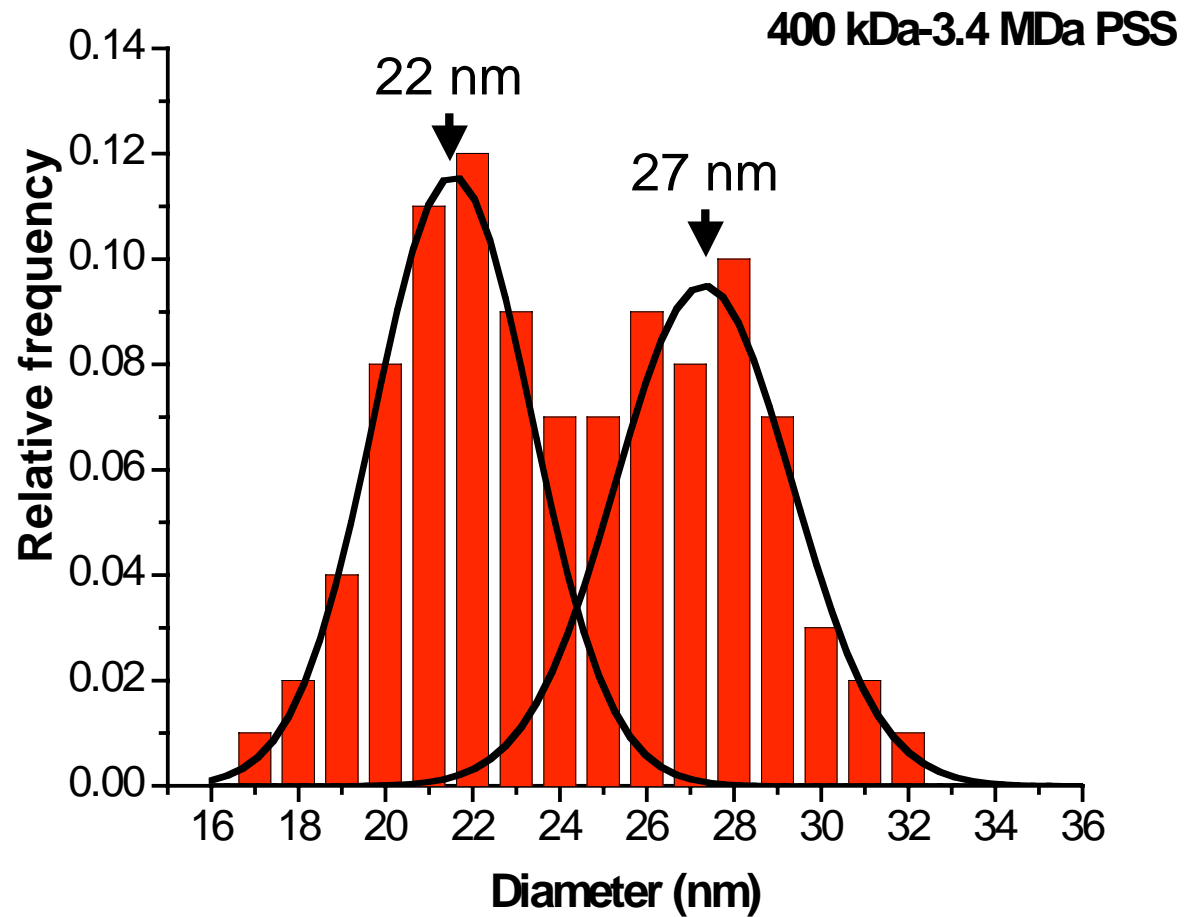

Estimation of T Numbers

T=2, 120
proteins

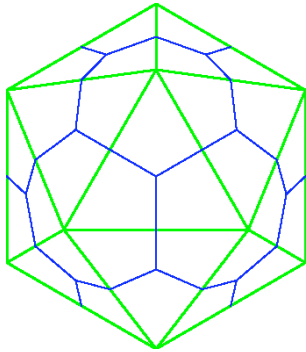

T=3, 180
proteins

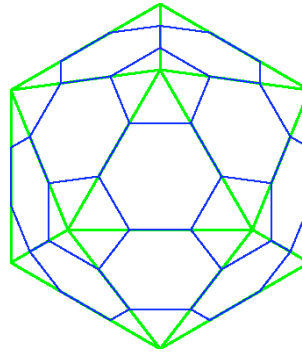

T=4, 240
proteins

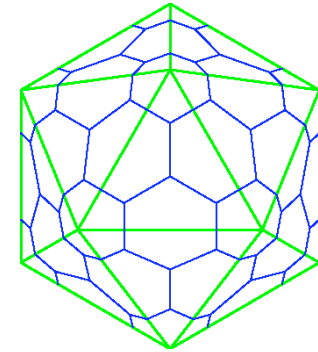

Capsid surface area is equal to $60T$ x surface area per capsid protein

$$\frac{D_{T1}}{D_{T2}} = \sqrt{\frac{T_1}{T_2}} \quad \longrightarrow \quad \frac{D_{T1}}{D_{T2}} = \frac{22}{27} = \sqrt{\frac{2}{3}}$$

Estimation of T Numbers

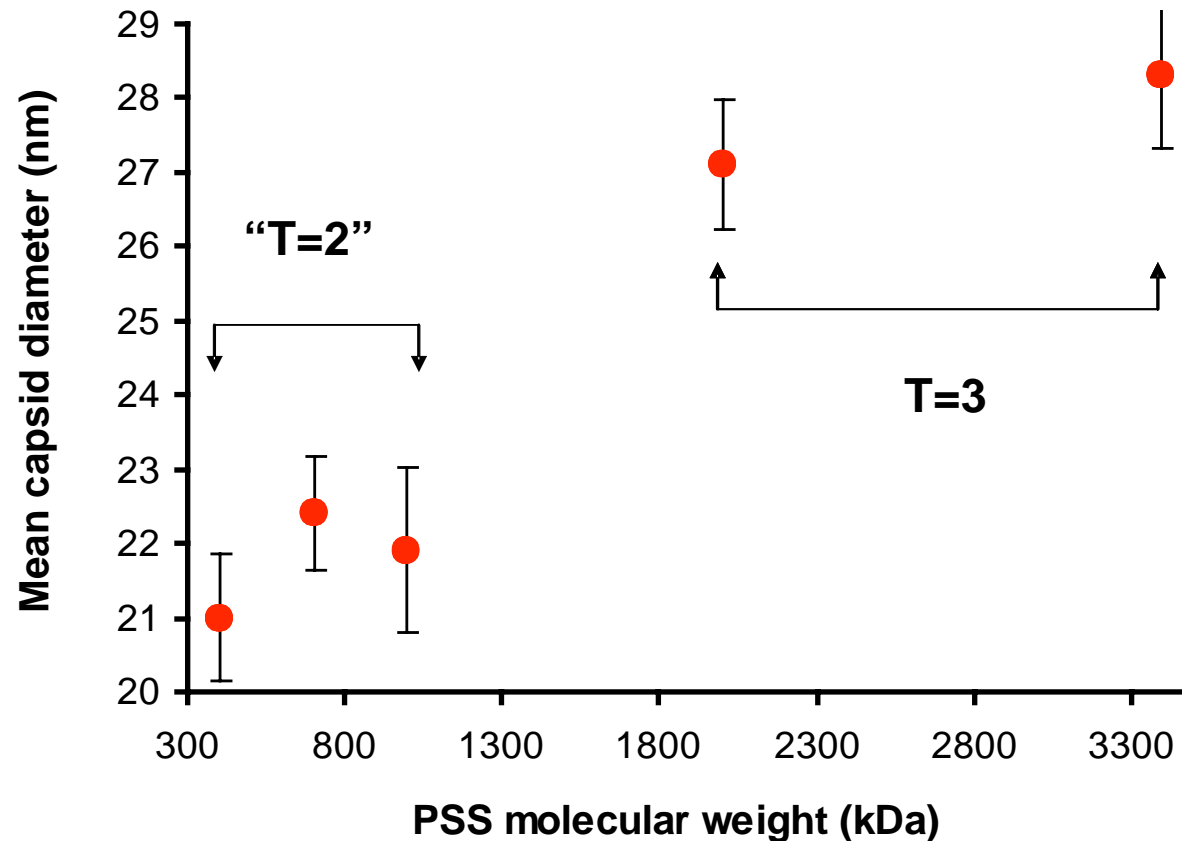

The observed capsid diameters of 22 and 27 nm correspond to T=2 and T=3 triangulation numbers

Higher MWs of polymer give larger protein shells...

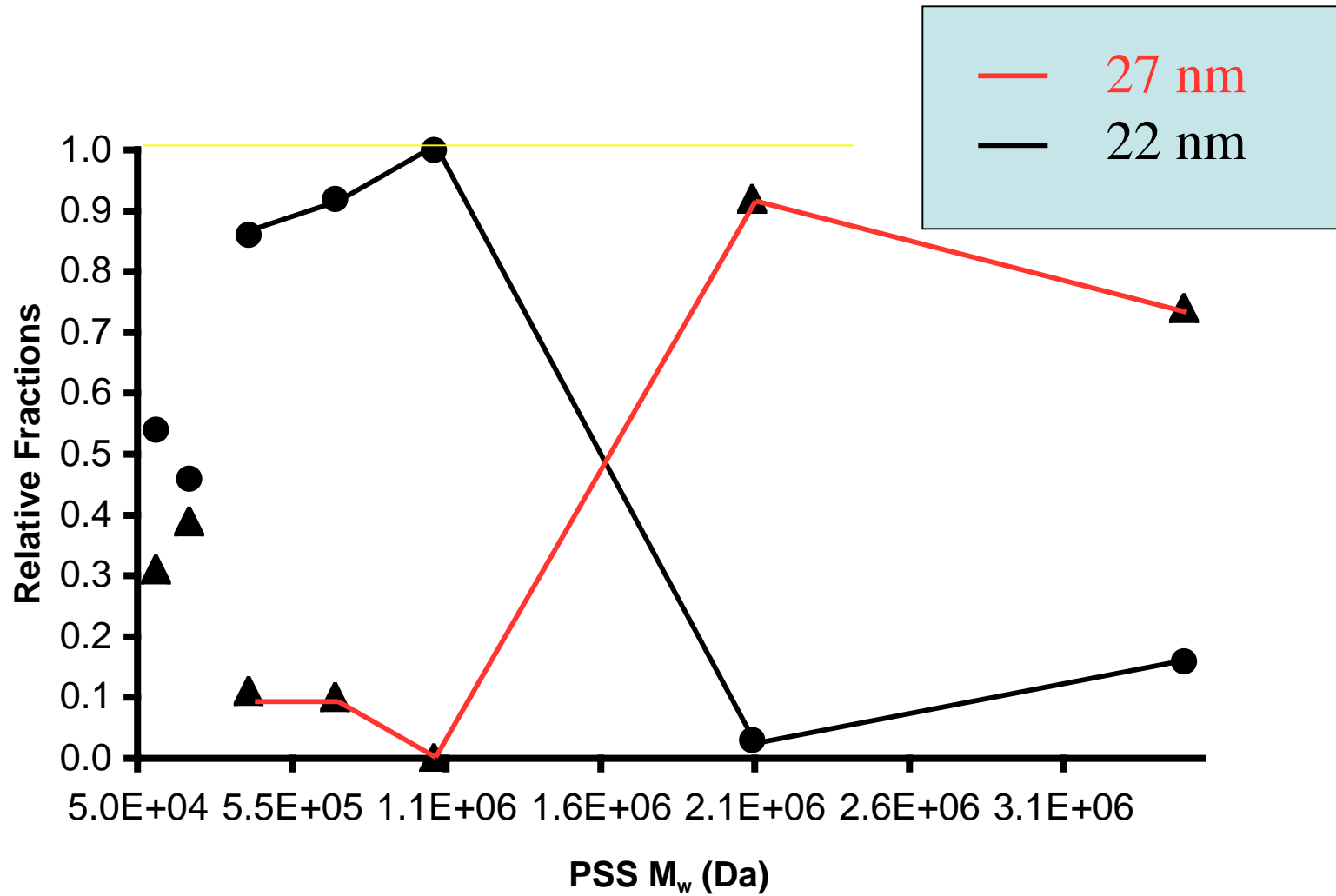

Equilibrium Centrifugation

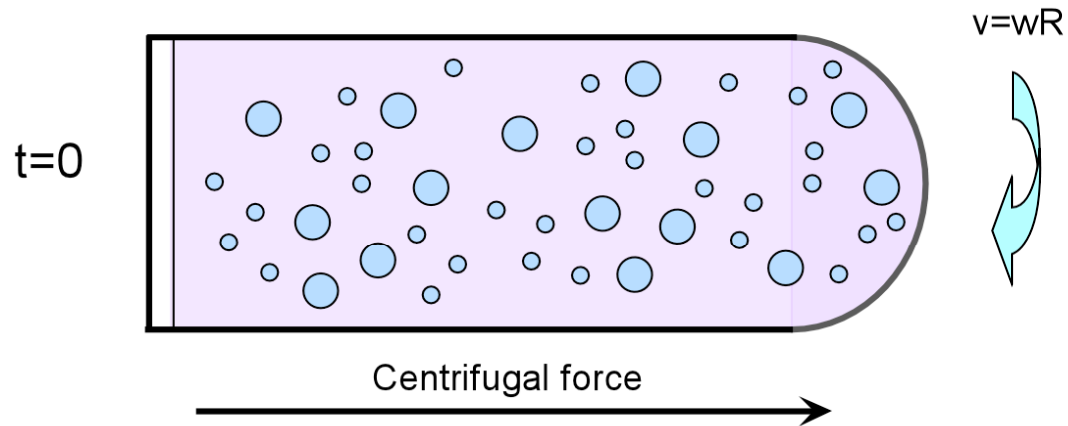

- VLPs are loaded onto cesium chloride density gradient and centrifuged

- Particles are separated by density at equilibrium

- Particle molecular weight can be calculated from its equilibrium distribution profile in the gradient

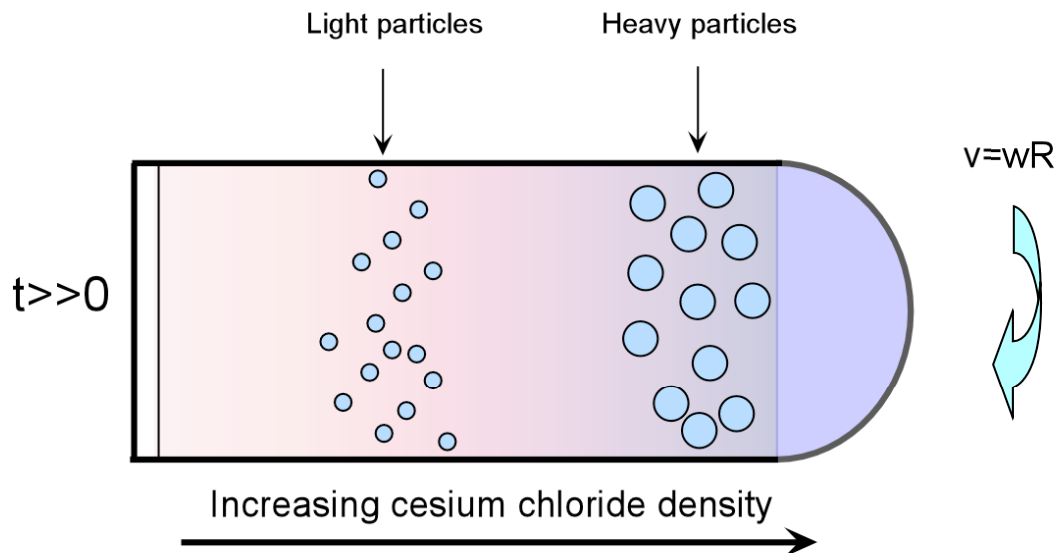

Molecular Weight Estimation for VLP 1M

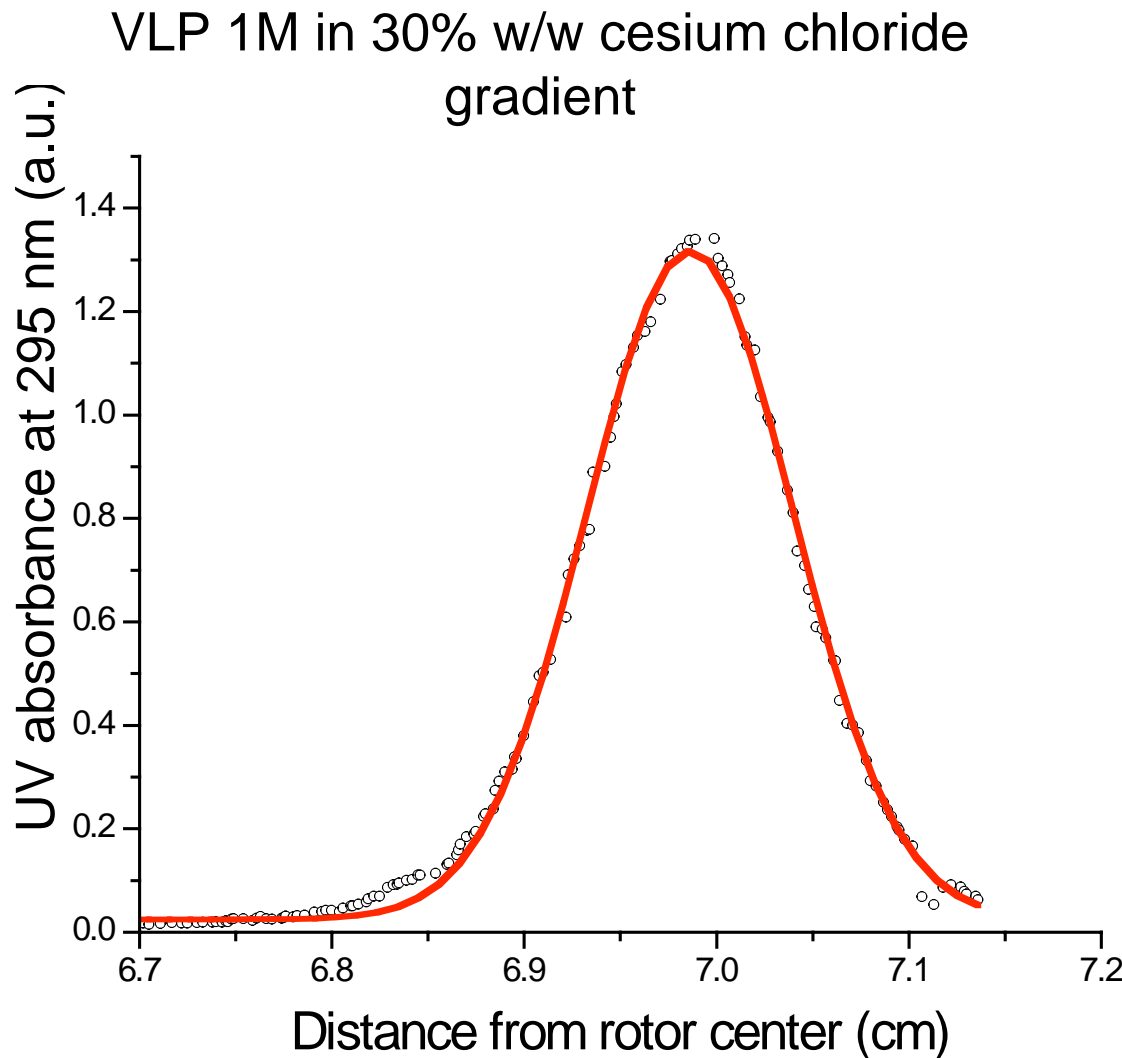

- The molecular weight of a Gaussian band is

$$M_w = \frac{RT}{\omega^2 r \bar{v} (d\rho/dr) \sigma^2}$$

- The estimated molecular weight of the species in the band is 3.7×10^6
- The molecular weight of anhydrous VLP 1M with 120 proteins and 1 PSS inside is 3.4×10^6
- VLP 1M has T=2 capsid

What determines the size and shape of an RNA in solution under the conditions of assembly?

**Problem: RNA is not a linear polymer,
 nor a simple branched one... Don't
 know how its size depends on molecular weight, *or*
 on sequence....**

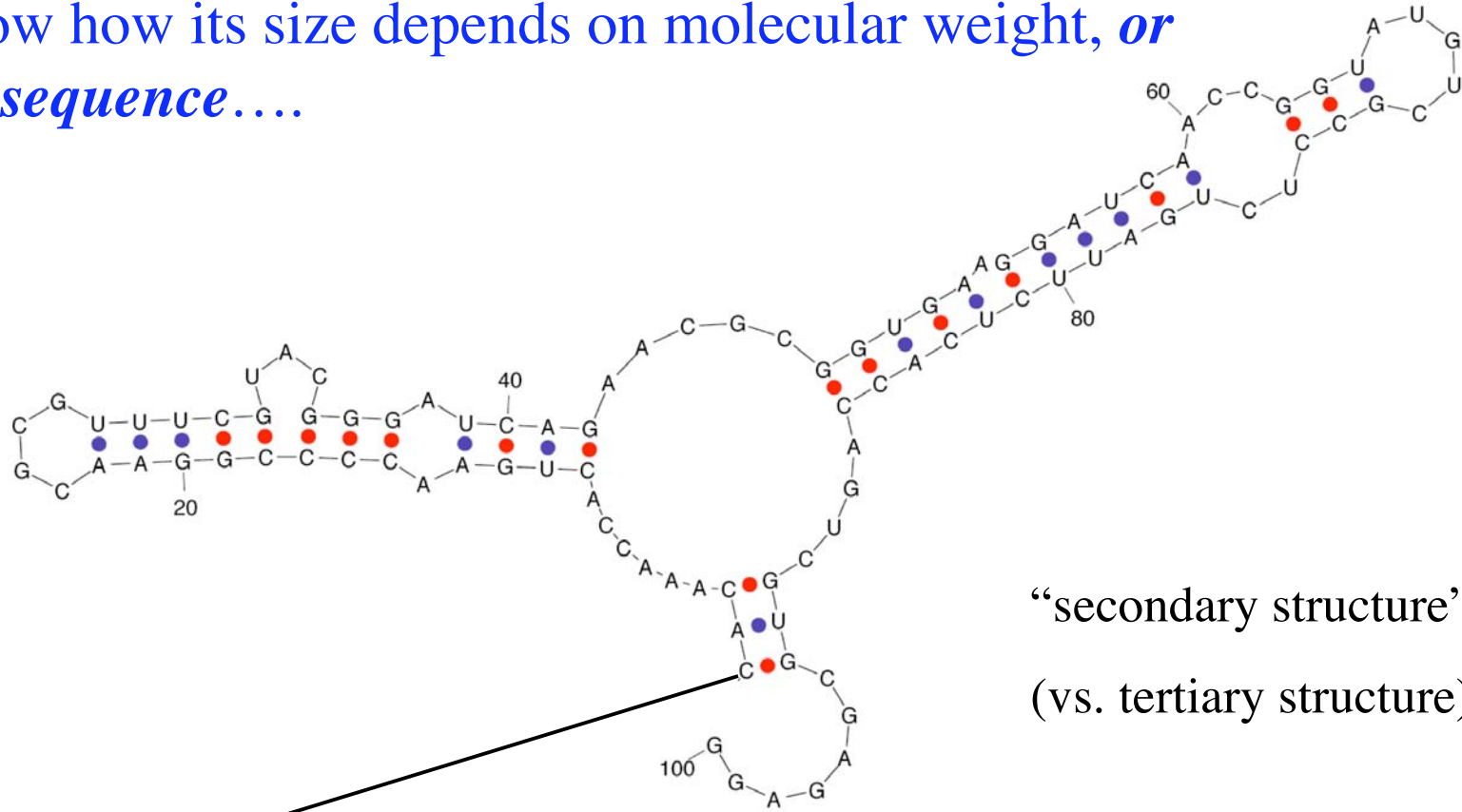

“secondary structure”
 (vs. tertiary structure)

(5') CACAAACCACUGAACCCCGGAACGCGUUUCGUACGGGAUCAGAACGCGGU
 GAAGGAUCAACCGGUAUGUCGCCUCUGAUUCUCACCAGUCGUGCGAGAGG(3')

What is the 3D size and shape of a (viral-length) RNA molecule?

E.g., CCMV RNA2, which is about 2800 nt long

Start with its secondary structure...

(from MFOLD)

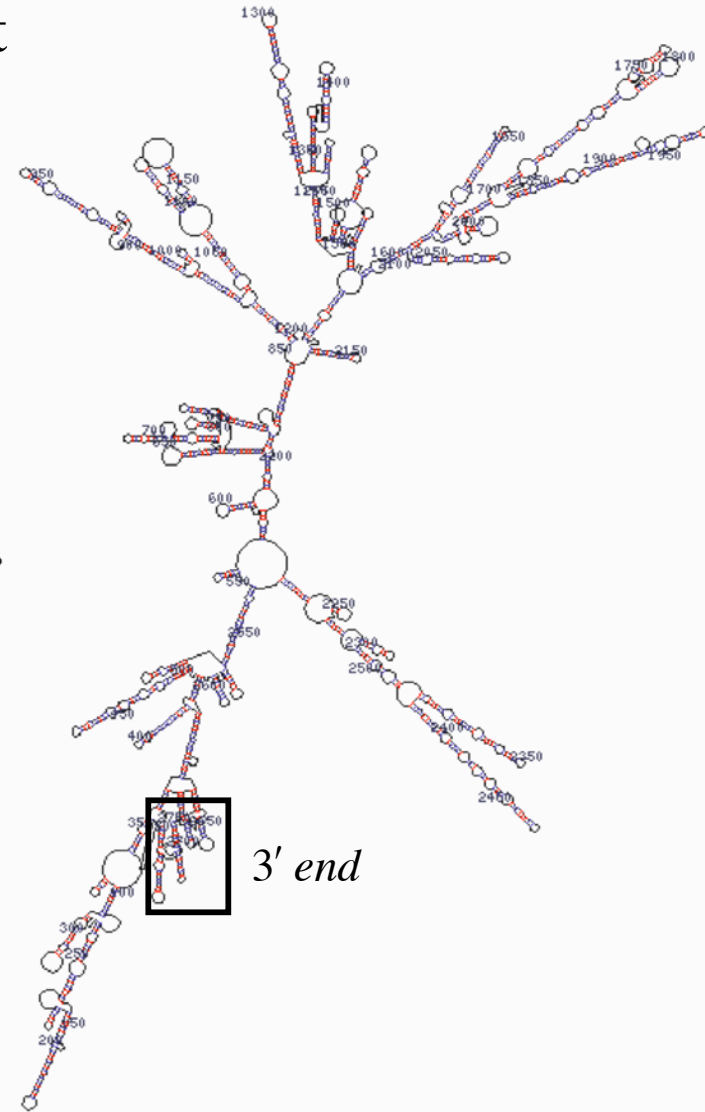

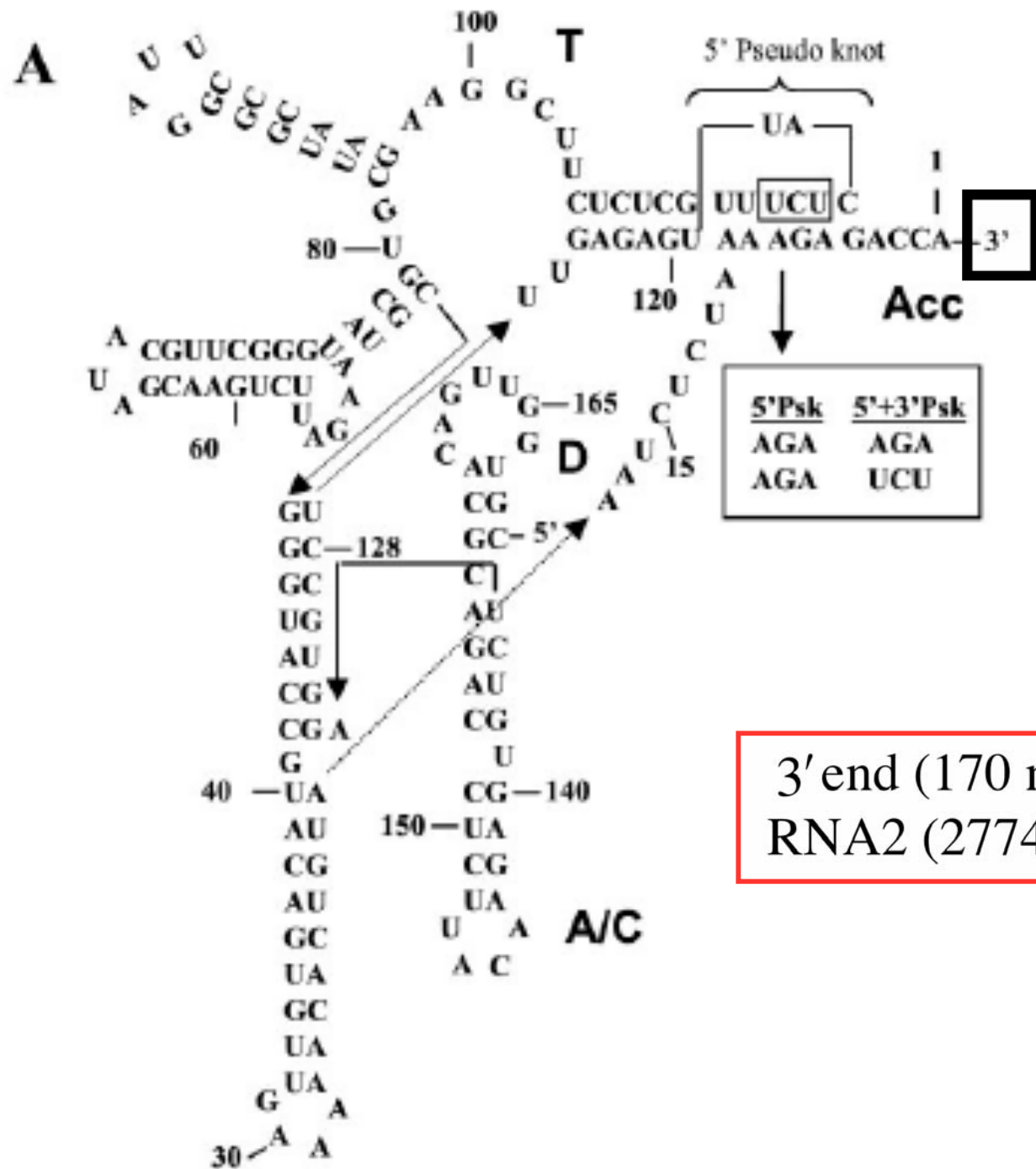

3' end (170 nt) of CCMV RNA2 (2774 nt)

Use SAXS to determine 3D size & shape...

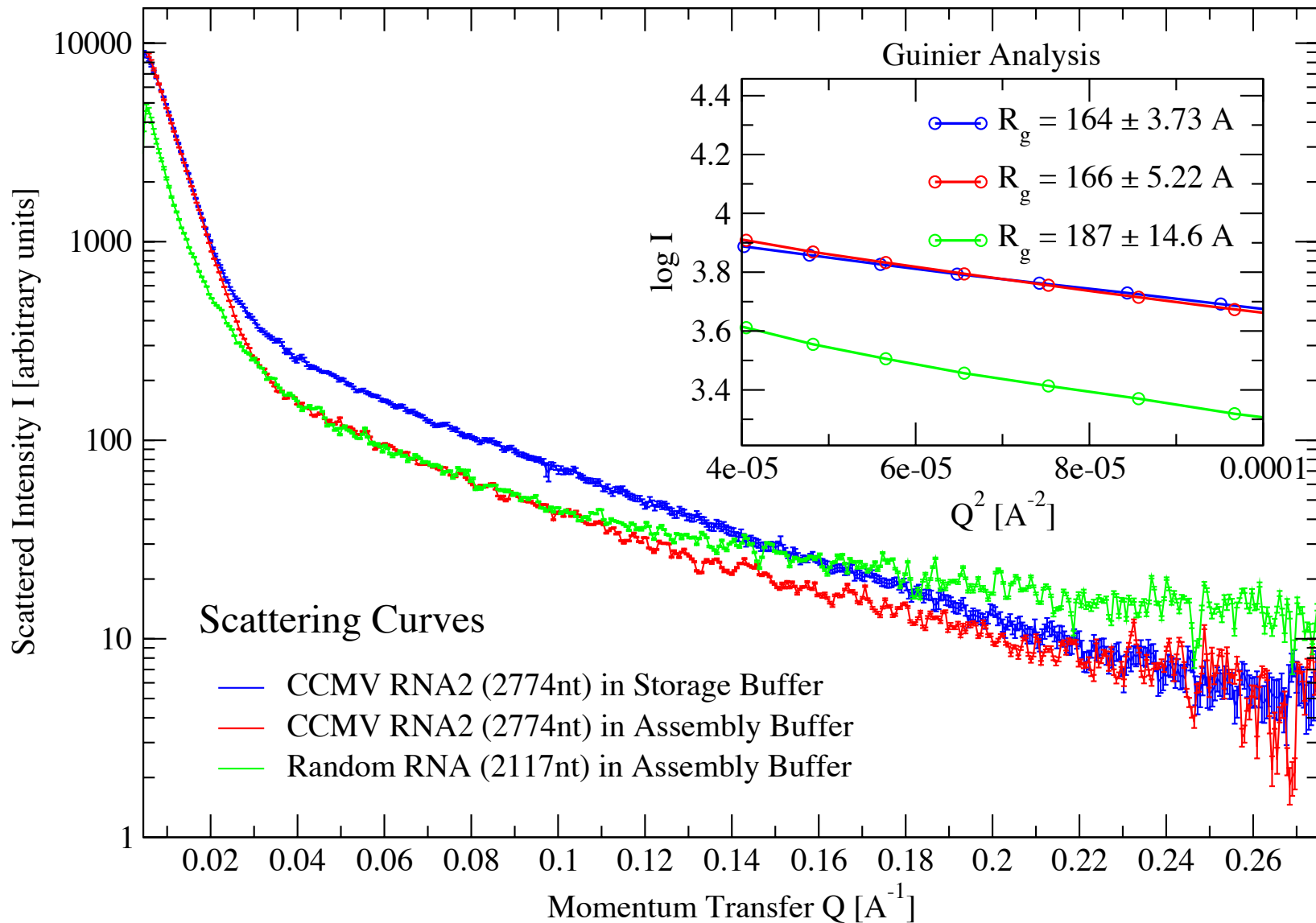

**3D coarse-grained model fit to
CCMV RNA2 scattering $[I(q)]$ data**

D. Svergun, S. Doniach

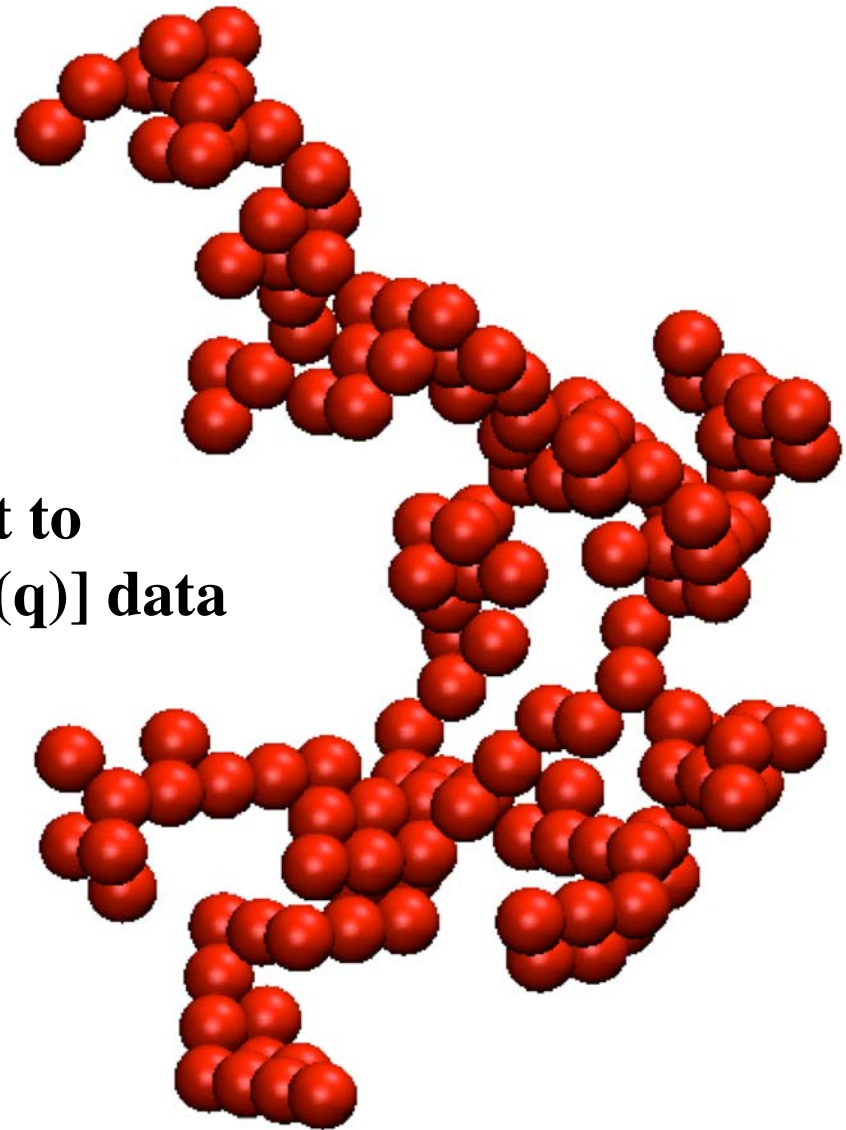

Real-space image reconstruction of CCMV RNA2
from small-angle synchrotron X-ray scattering $I(q)$

$$R_{\text{RNA}} \approx R_{\text{capsid}}$$

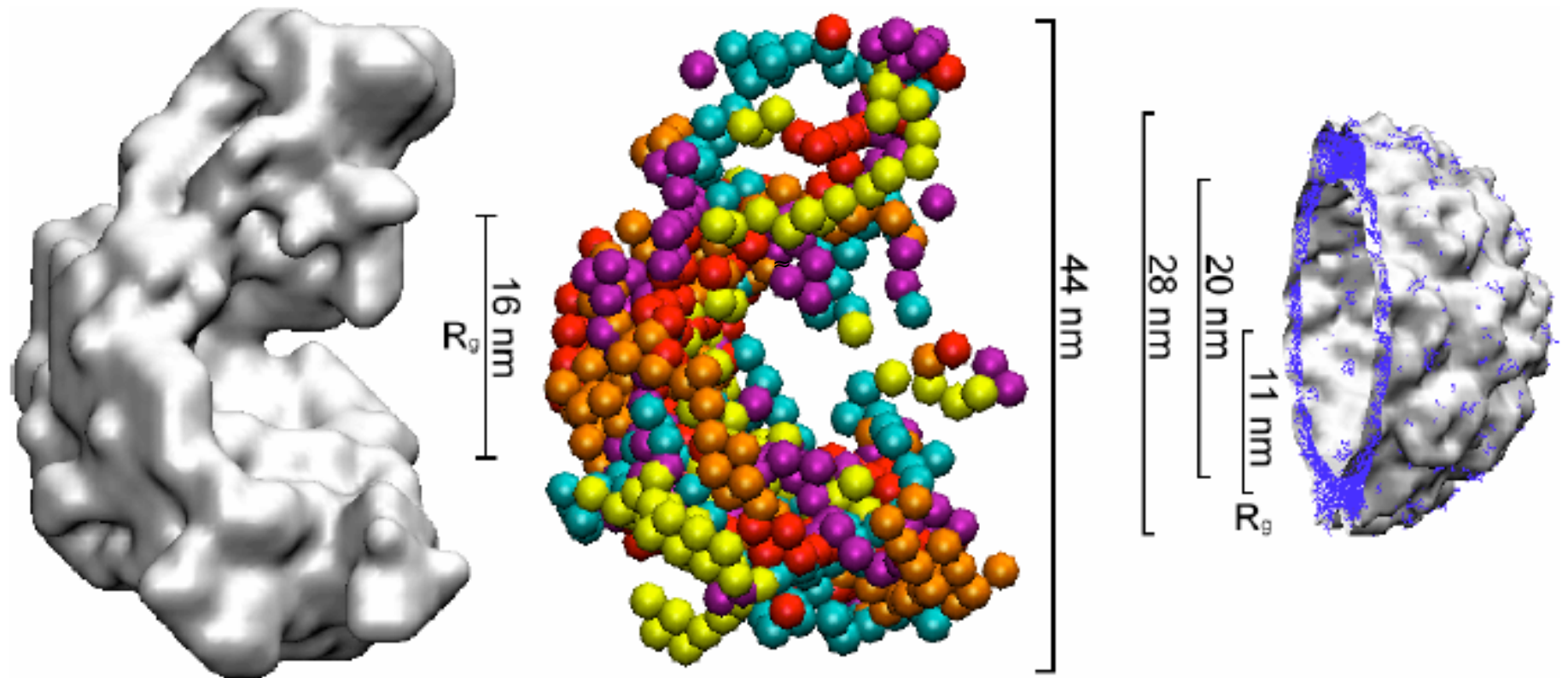

Comparison of Percent Base Pairing and Average Duplex Length in Viral, Random, and Ribosomal RNA

- Viral genome sequences have evolved *not only* to yield optimal gene products, *but also* to have a size and shape that ensures they will be encapsidated.
- Therefore, if the above coarse-grained characteristics are predictive for size, their values for random, viral, and ribosomal RNA should differ markedly. **BUT THEY DON'T. E.g., base pairing essentially always 60%.**
- **The distributions of duplex lengths are also the same for all three RNAs.**

CHARACTERISTIC	AVG. OF 25 2800-BASE RANDOM RNAs	AVG. OF 4 VIRAL RNAs (CCMV& BMV RNAs 1+2)	<i>E. Coli</i> ribosomal RNA, 2825 BASES
% OF BASES IN PAIRS	60.8 ± 1.1	63.5 ± 1.9	62.0
AVERAGE DUPLEX LENGTH	4.4 ± 0.1	4.7 ± 0.1	4.4

Distribution of Duplex Lengths Does Not Differ Markedly Between Random and Biological RNAs

DISTRIBUTION OF DUPLEX LENGTHS IN RANDOM AND BIOLOGICAL RNAs

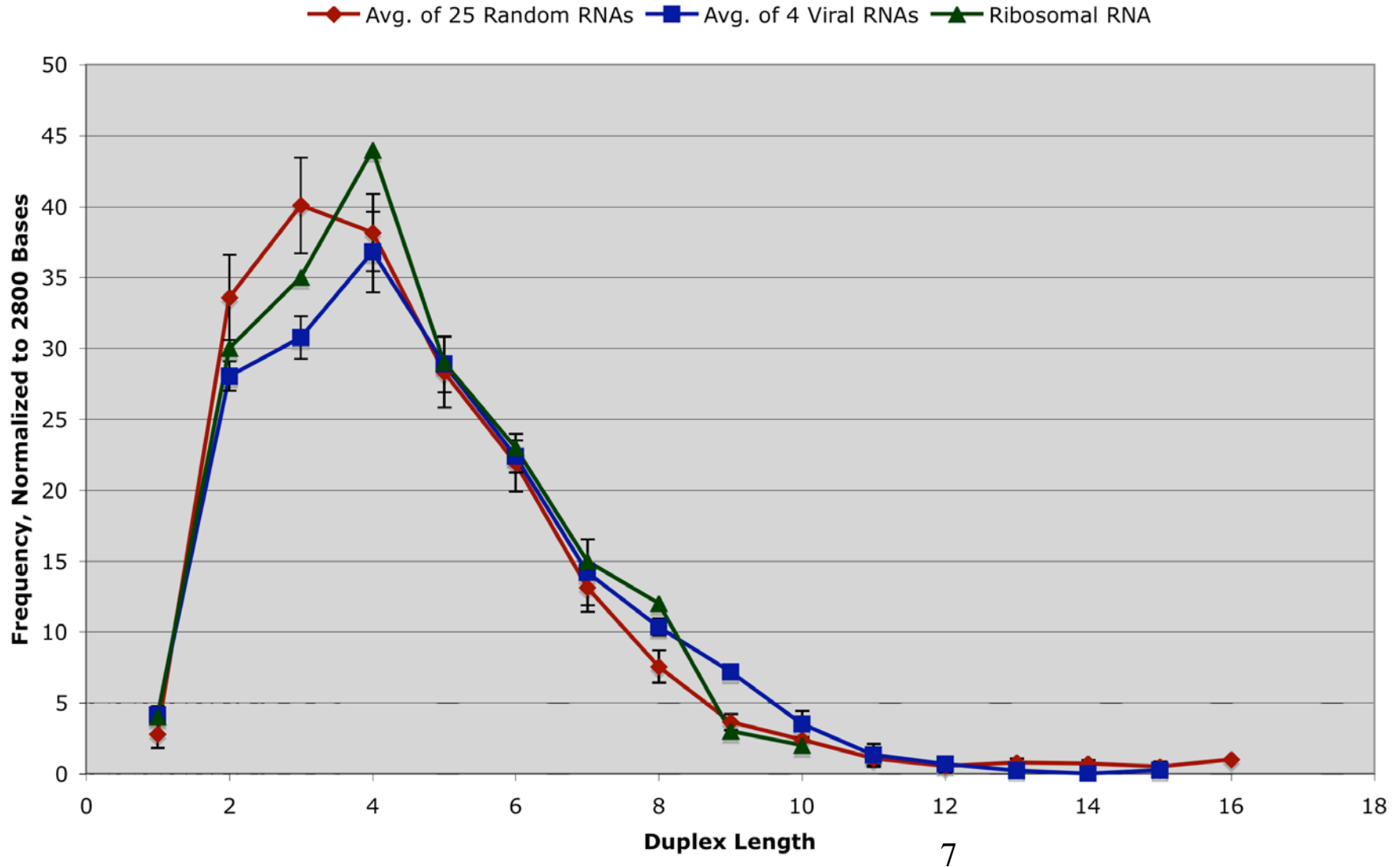

There is a Large Difference in **Maximum Ladder Distance (MLD)** Between These Random and Viral RNAs

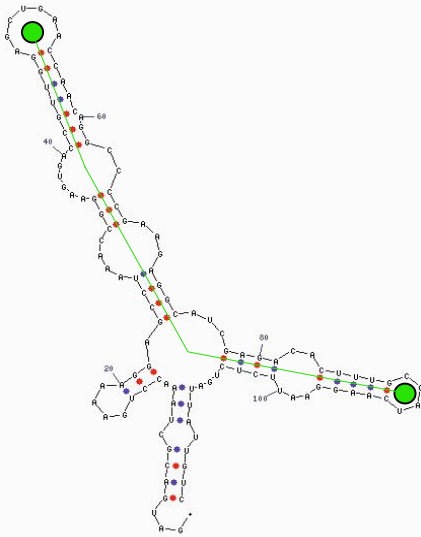

The MLD in this structure is 23, the number of base pairs crossed by the path connecting the two green dots.

- Bundschuh and Hwa have introduced the “ladder distance” as a quantitative measure of size in RNA secondary structures; h_{ij} is the number of base pairs that are crossed by the shortest path connecting bases i and j .
- To characterize the size of RNA secondary structures using a single quantity, we calculate the “**maximum ladder distance**” -- the largest value of h_{ij} for all combinations of i and j -- **it is the longest path across the secondary structure.**

CHARACTERISTIC	AVG. OF 25 2800-BASE RANDOM RNAs	AVG. OF 4 VIRAL RNAs (CCMV RNAs 1+2, BMV RNAs 1+2)	<i>E. Coli</i> RIBOSOMAL RNA, 2825 BASES
MAX. LADDER DISTANCE	291.0 ± 38.1	206.4 ± 8.3	235.9

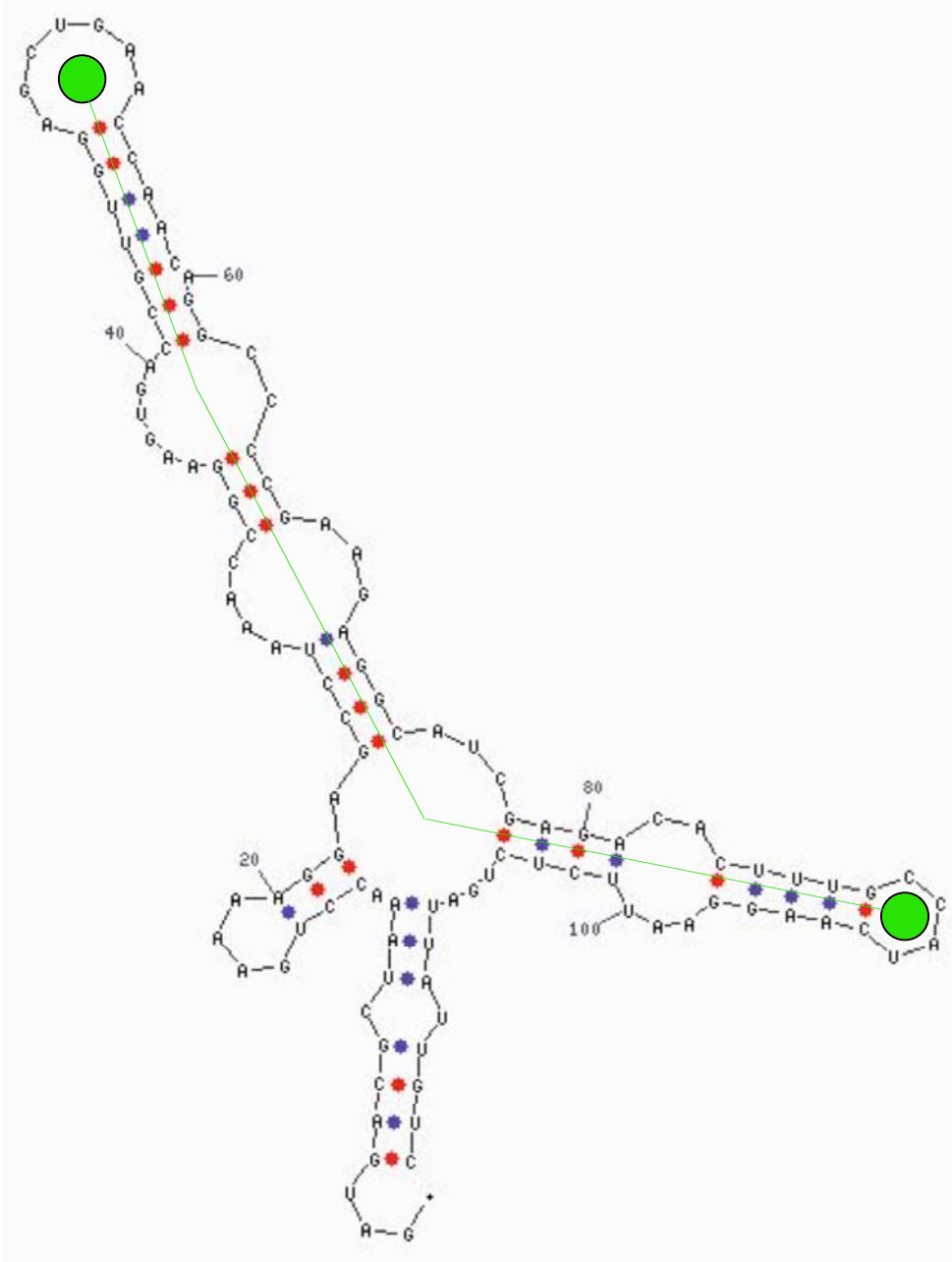

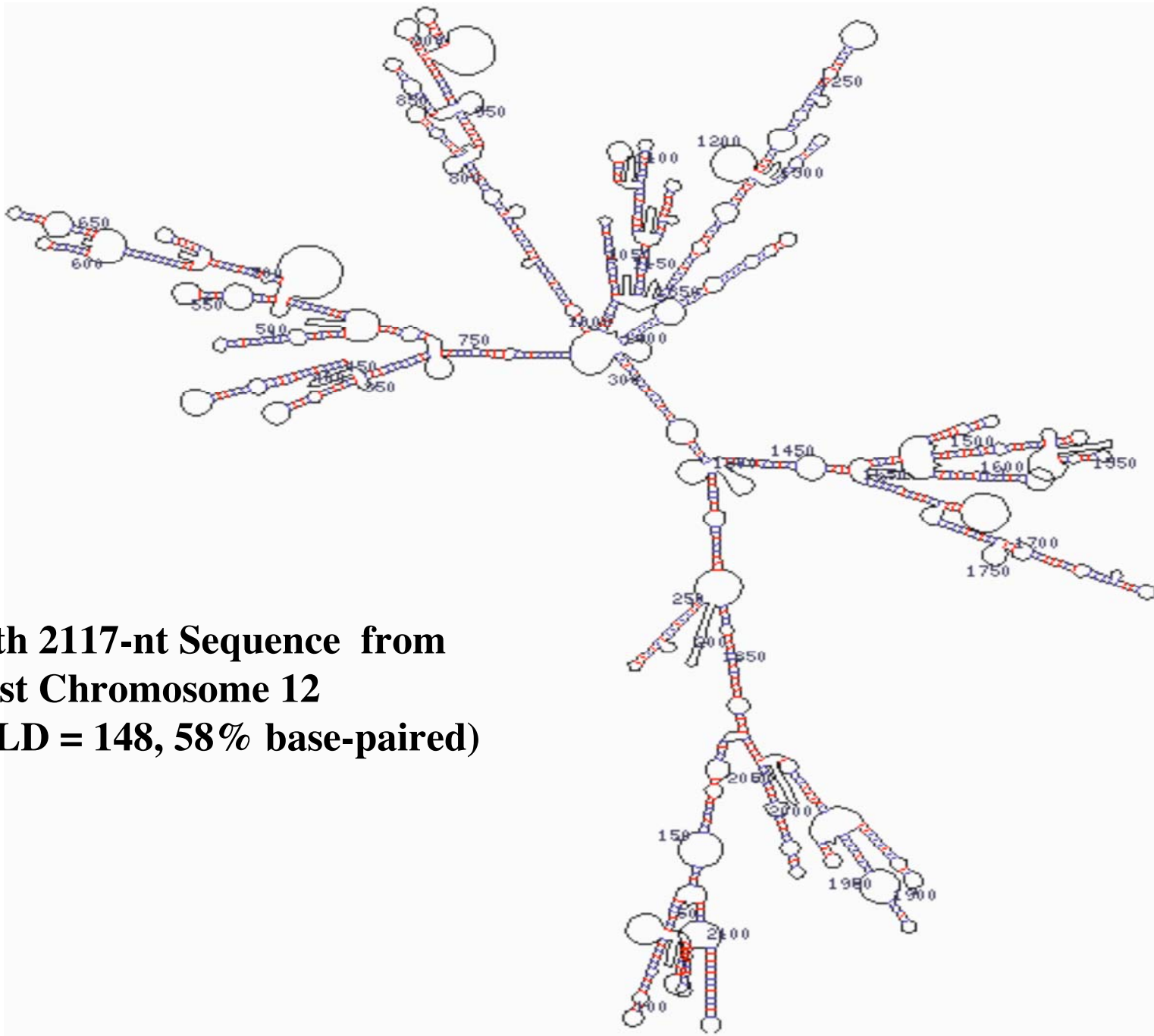

**326th 2117-nt Sequence
from Yeast Chromosome 12
(MLD = 368, 61% base-paired)**

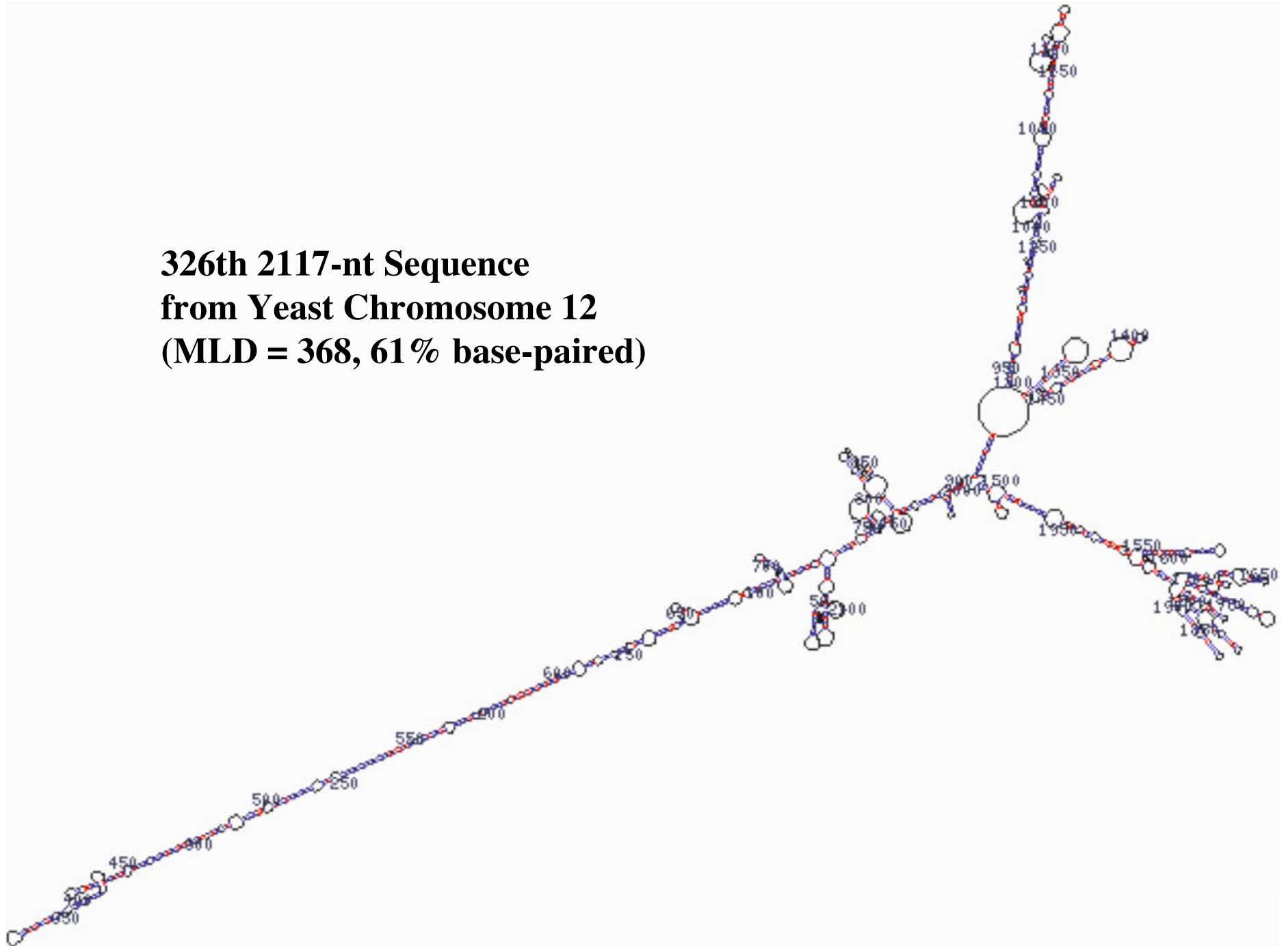



Determine Sequence-Dependence of RNA Size and Shape

BMV RNA3, 2117nt
(packages)

BMV RNA3Rev, 2117nt
(does not package)

BMV RNA3Neg-sense, 2117nt

COMPARE AND CONTRAST TO

Control Sequences, 2117nt
("random" Yeast RPS22B)

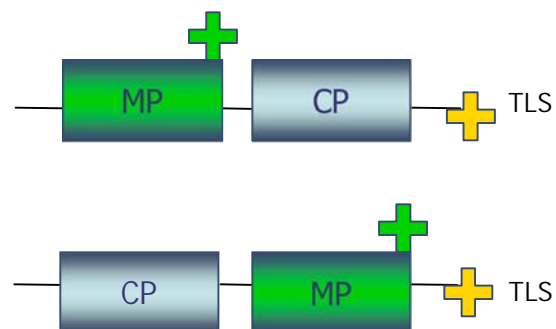

CHARACTERISTICS OF 2117 nt RNAs

	MLD	% Pairing	% GC
BMV3	183	62	48
BMV3REV	185	64	48
BMV3NG	207	59	48
YEAST182	182	59	43
YEAST266	266	61	35
YEAST368	368	62	32
AV. 509 YEAST RNAs	239	58	38
RANGE 509 YEAST RNAs	139 - 368	44 - 65	
AV. 509 RAND. RNAs	239		50
RANGE 509 RANDOM RNA	149- 358		50

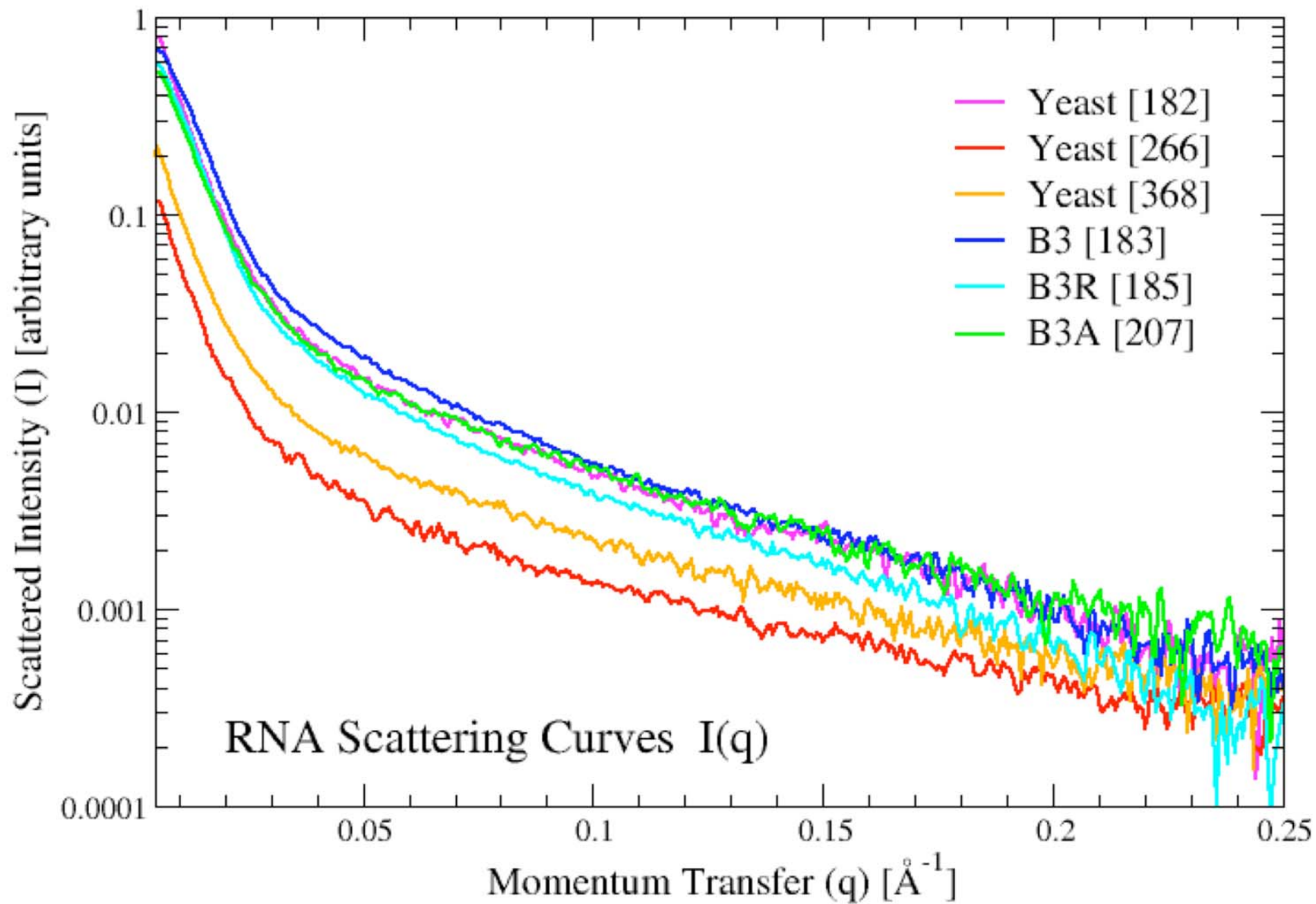

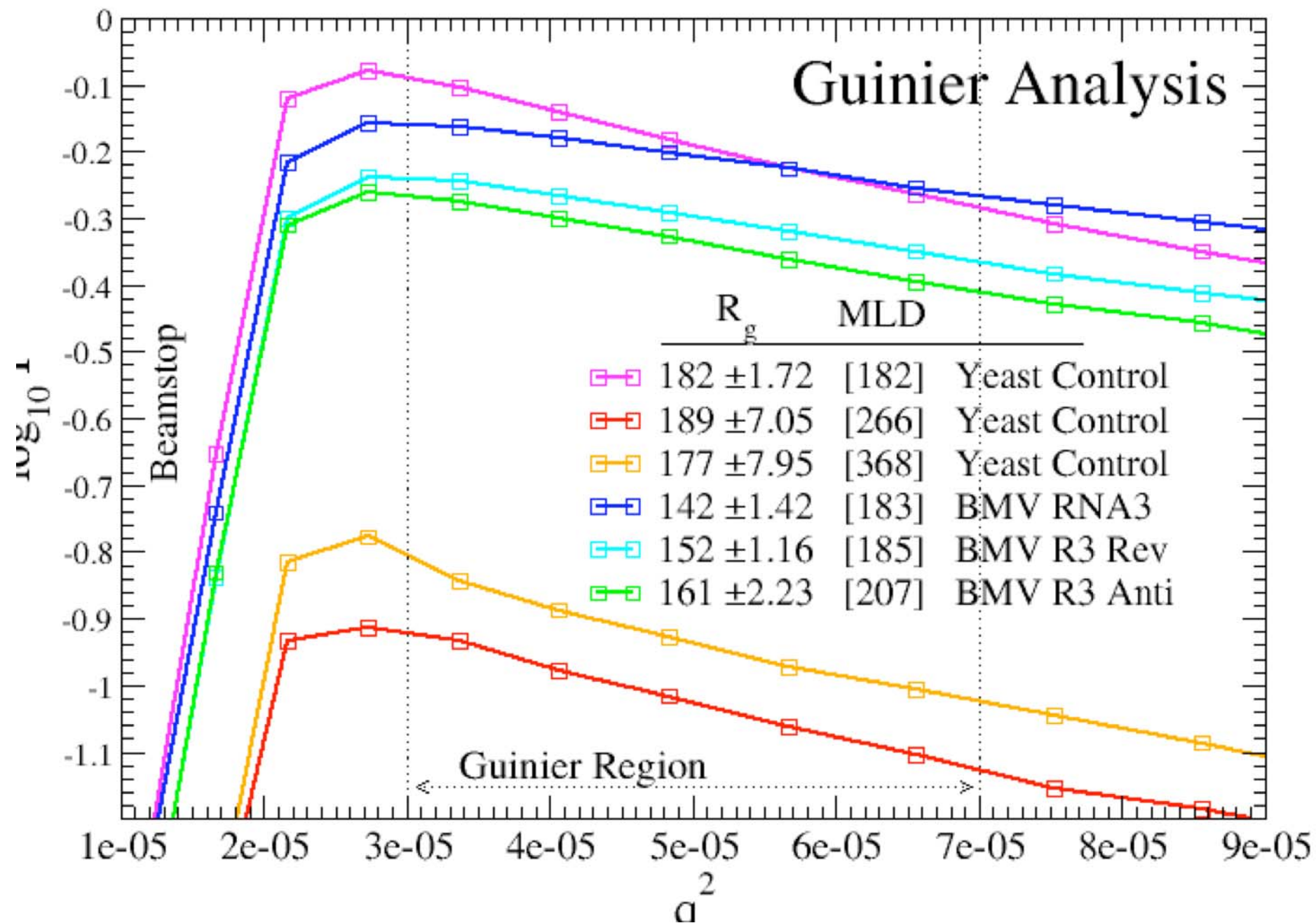

Pair Distribution Functions for RNA

$$P(r) = \frac{2}{r} \int_0^\infty s[I(s)]^{1/2} 2\pi r ds$$

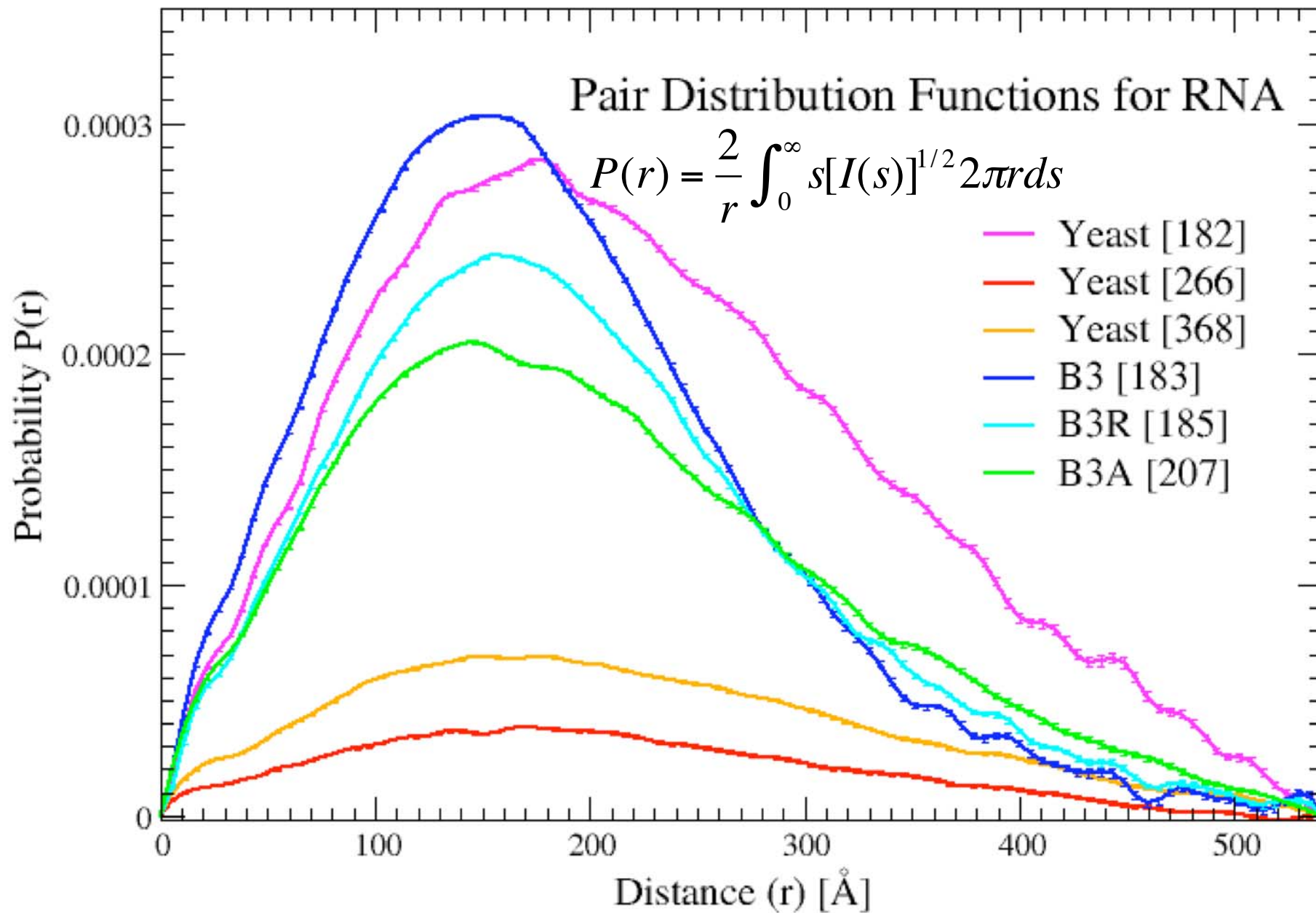

Experimental program for determining RNA genome size and its effect on packaging efficiency and viral infectivity

USING “ PHYSICAL MUTANTS” OF 2117-nt, wild-type, BMV RNA (I.E., SEQUENCE-SCRAMBLED, AND LENGTHENED):

- 1) Measure RNA R_g as function of nucleotide sequence and of overall length**
- 2) In buffer with purified capsid protein, measure *in vitro* packaging efficiency as function of same**
- 3) Transfect host cells and measure *in vivo* yields of:
replicated RNA
infectious nucleocapsids**

PUTTING IT TOGETHER

**HOW TO MAKE AN
ENVELOPED VIRUS**

E.g., Semliki Forest Virus (SFV)

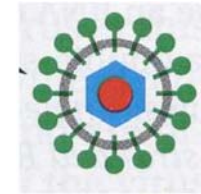
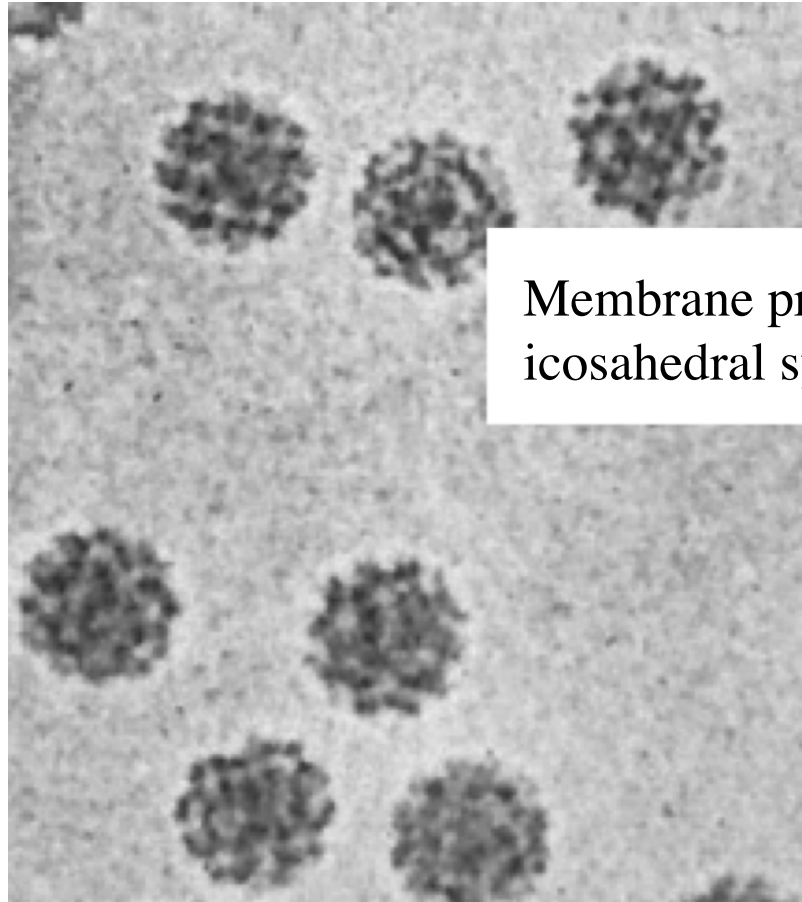

Membrane proteins have same icosahedral symmetry as capsid!

single molecule of ssRNA inside

Baker et al. (1999)

The “parts list” of an enveloped virus...

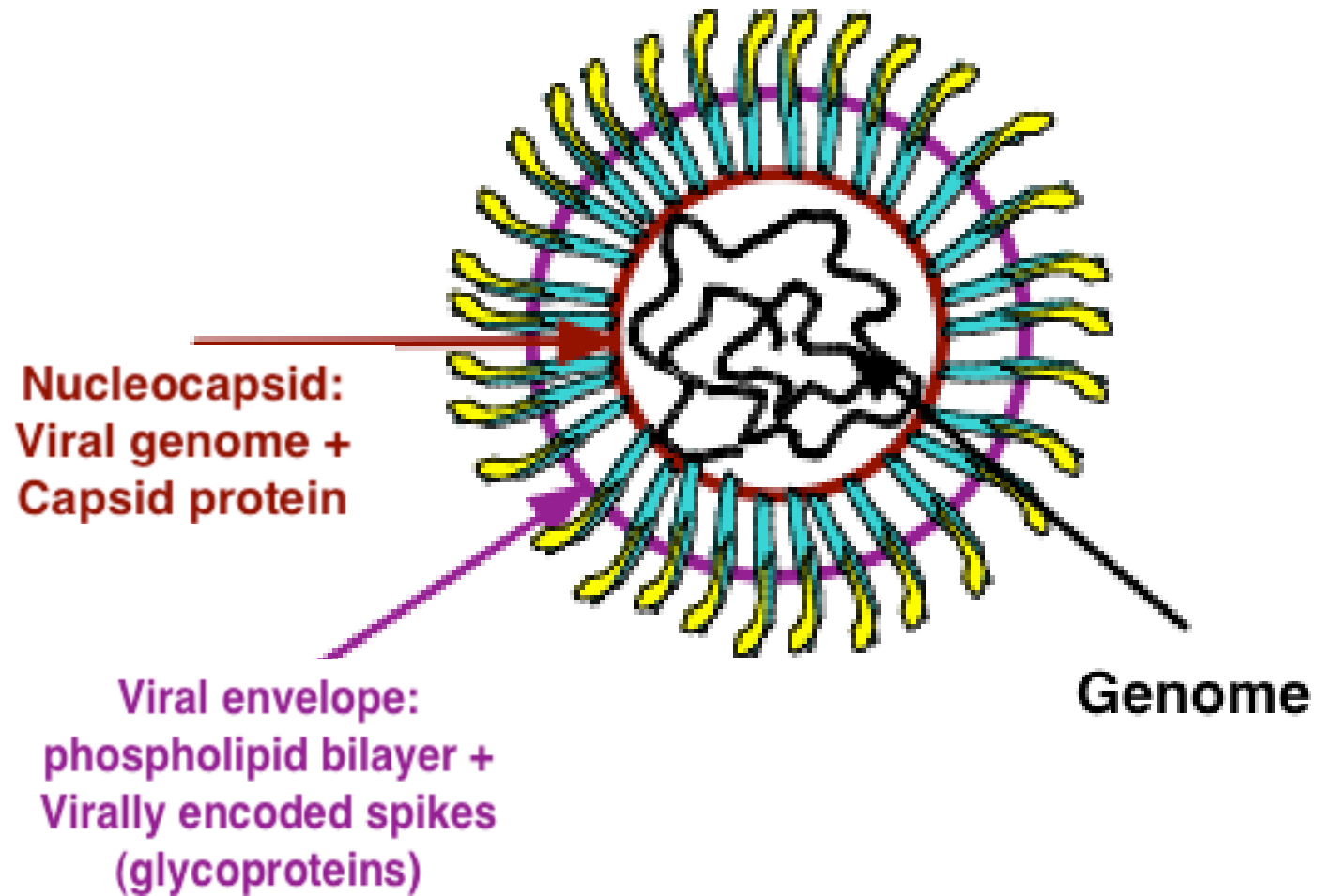

Putting the parts together...

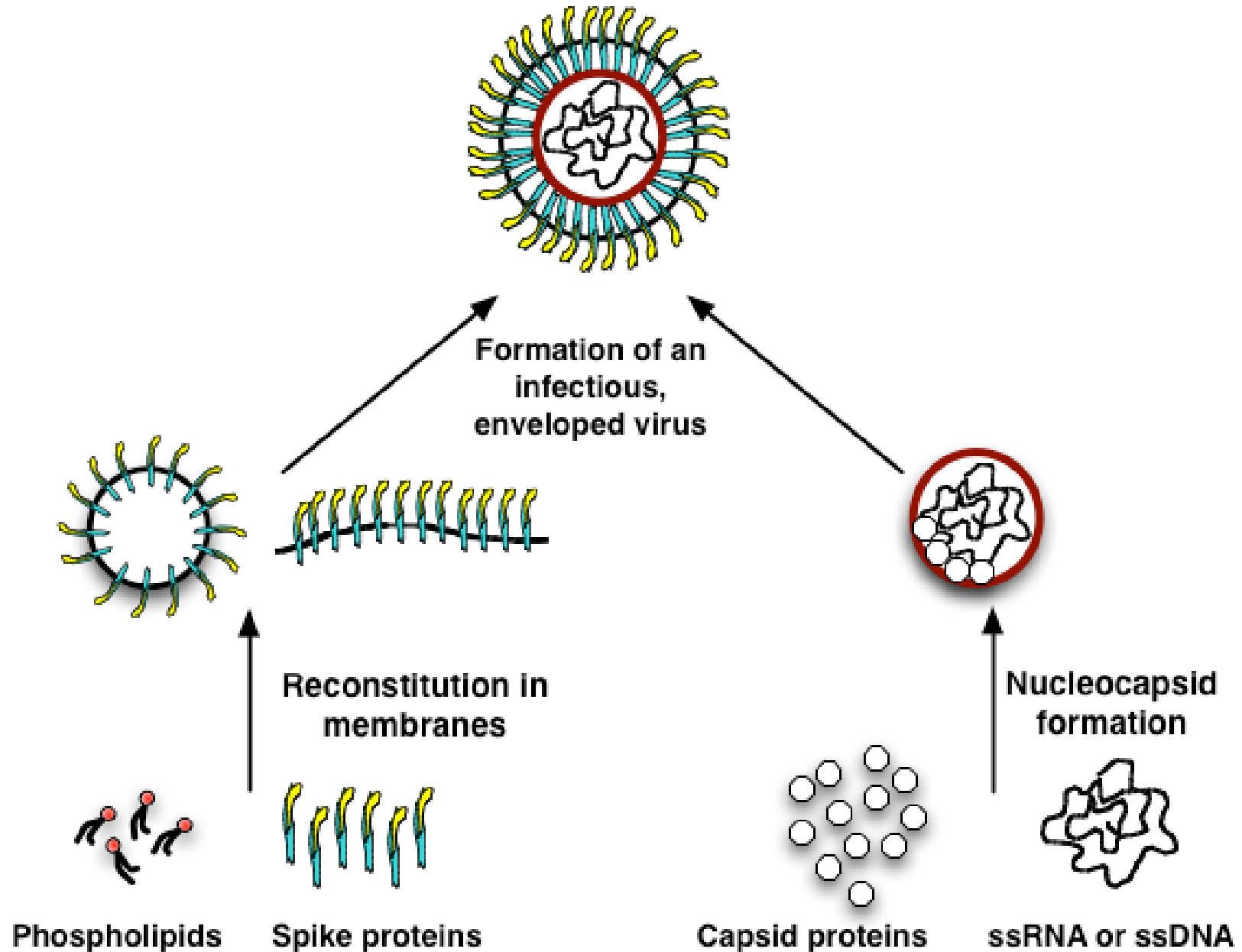

Sindbis: Virus of Choice

- Arguably the simplest animal virus: ***two-stage assembly*** life cycle
- Its nucleocapsid has been self-assembled *in vitro*
- One-to-one correspondence between each capsid protein and spike protein
- Strong interaction between capsid and spike proteins established *in vitro*
- Relatively benign

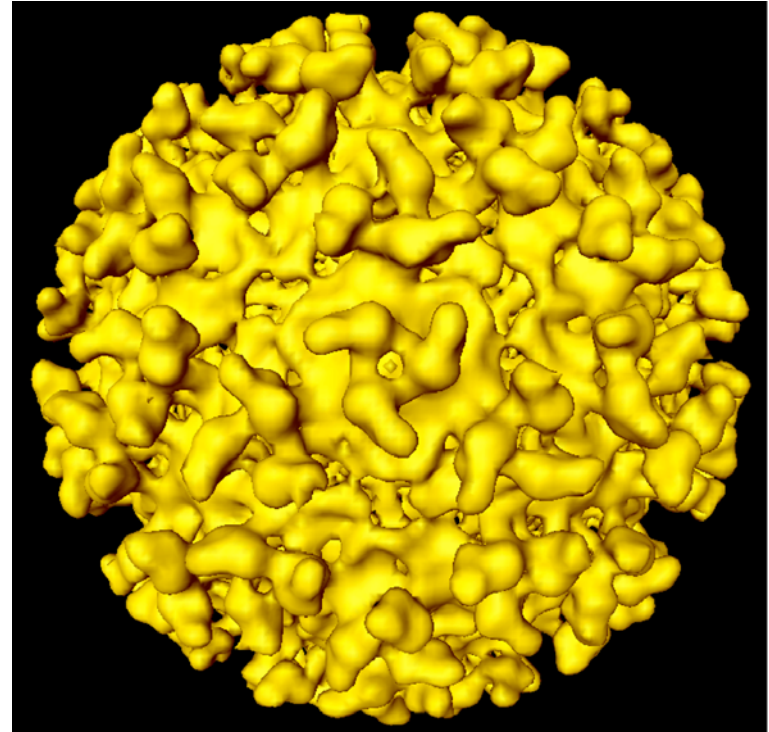

Sindbis reconstruction from cryo EM images (R. Kuhn)

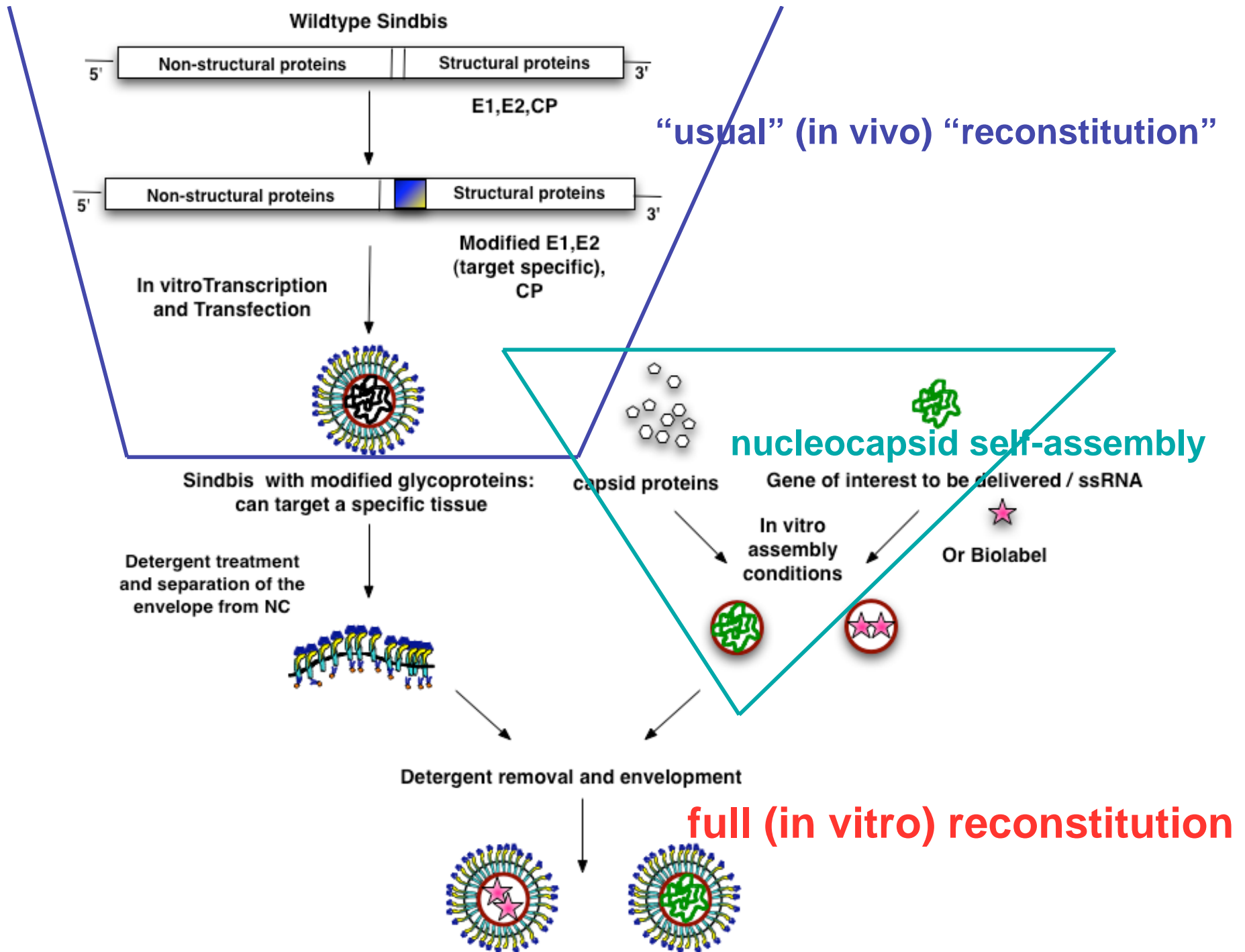

Sindbis cross-section

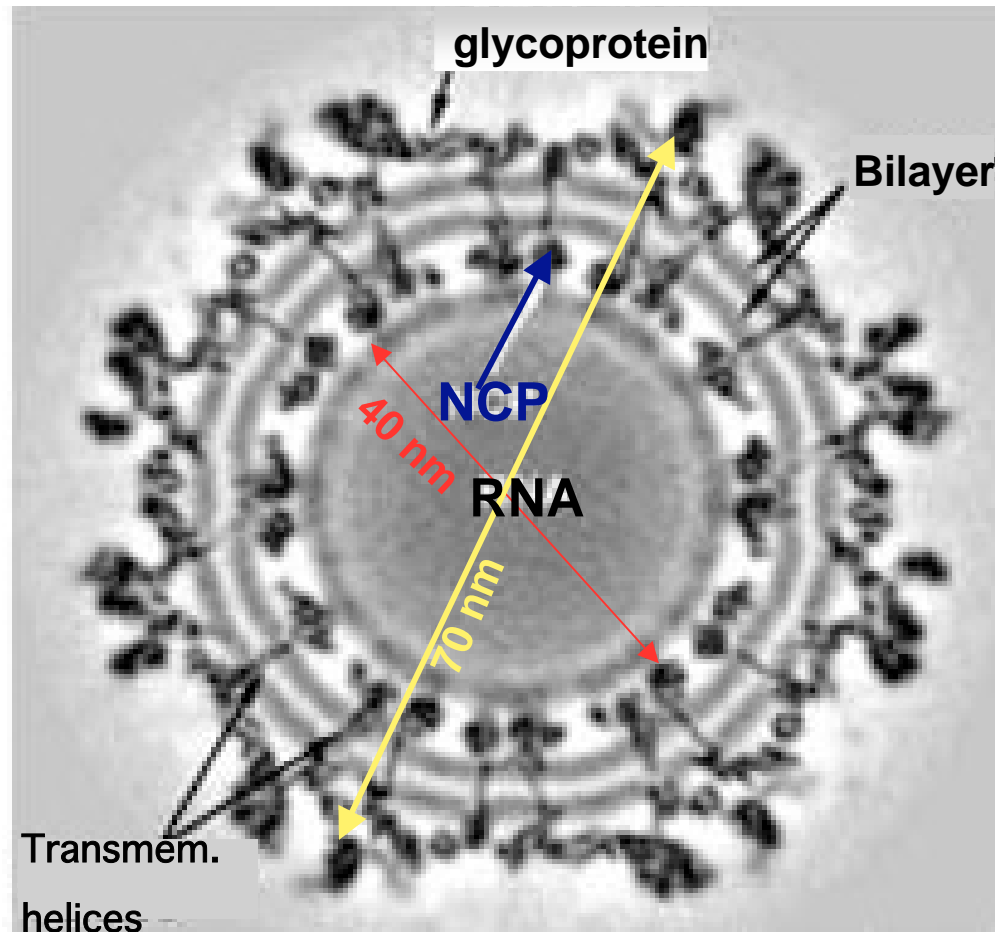

Zhang et al.
(2002)

We “peel off” envelope from nucleocapsid using detergent; then re-assemble it around the NC by removing detergent

Peeling off the membrane is possible!

Dissociation of the viral envelope from the nucleocapsid is stepwise (for SFV and Triton X-100 system)

Helenius and Söderland, *Biochimica et Biophysica Acta*, 307 (1973), 287-300.

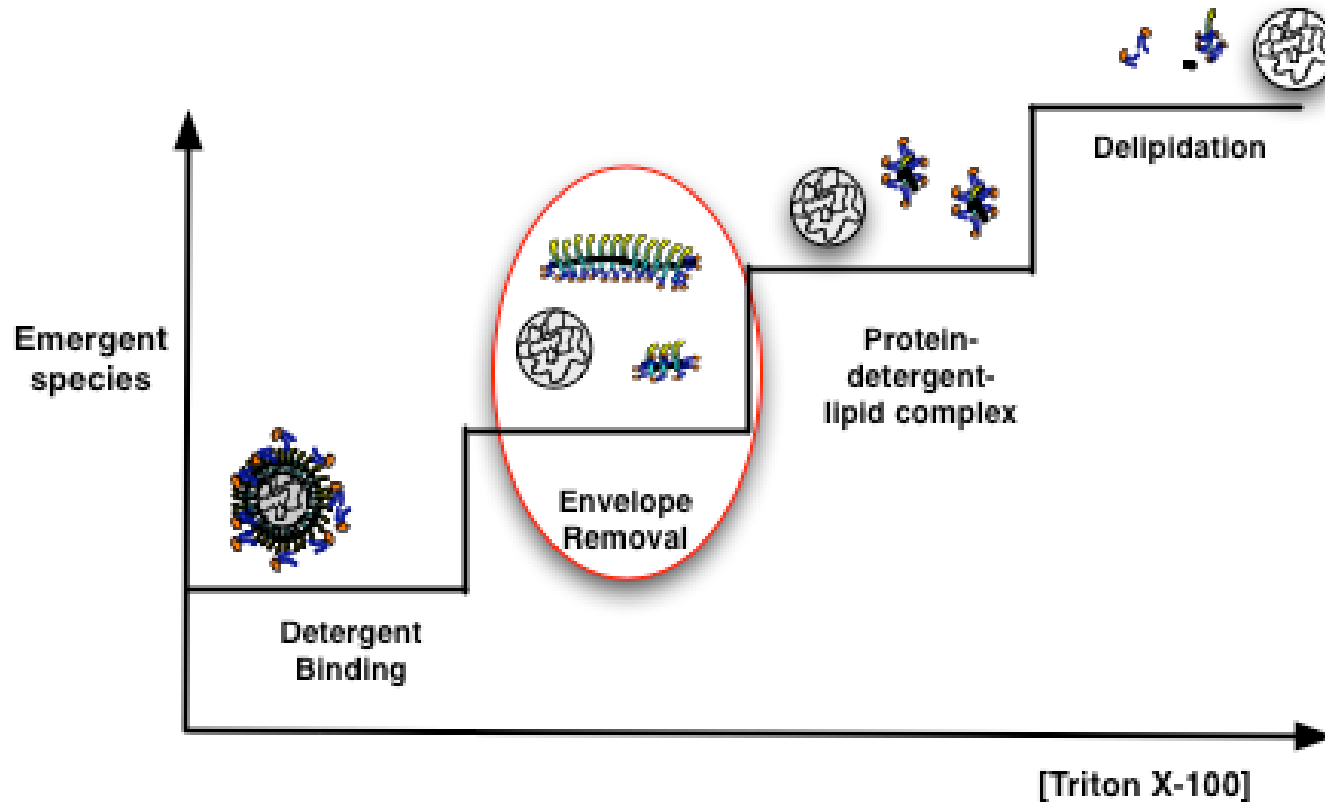

“Proof of Principle” Experiment

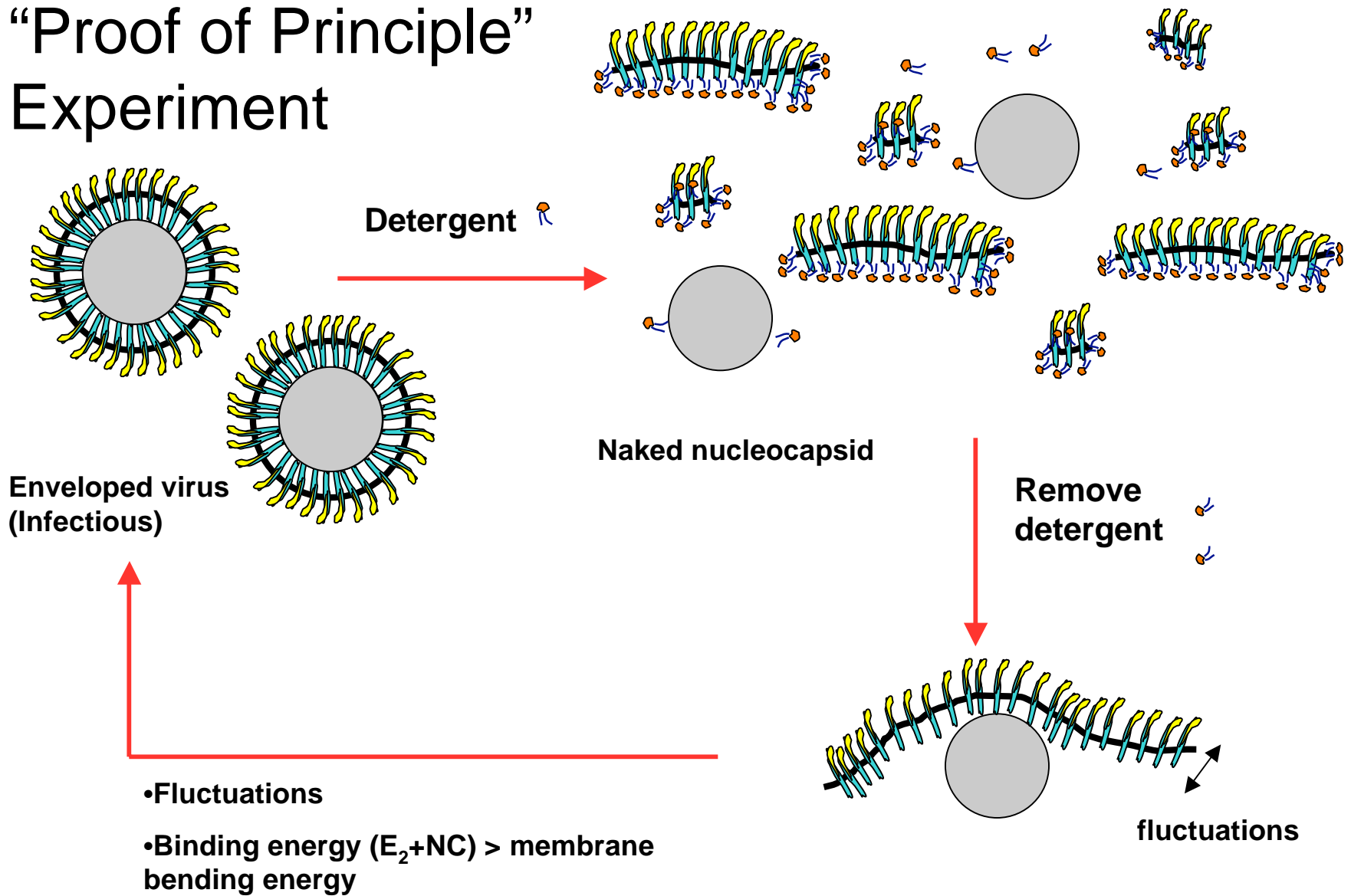

Physical separation of nucleocapsids and viral membranes after detergent treatment

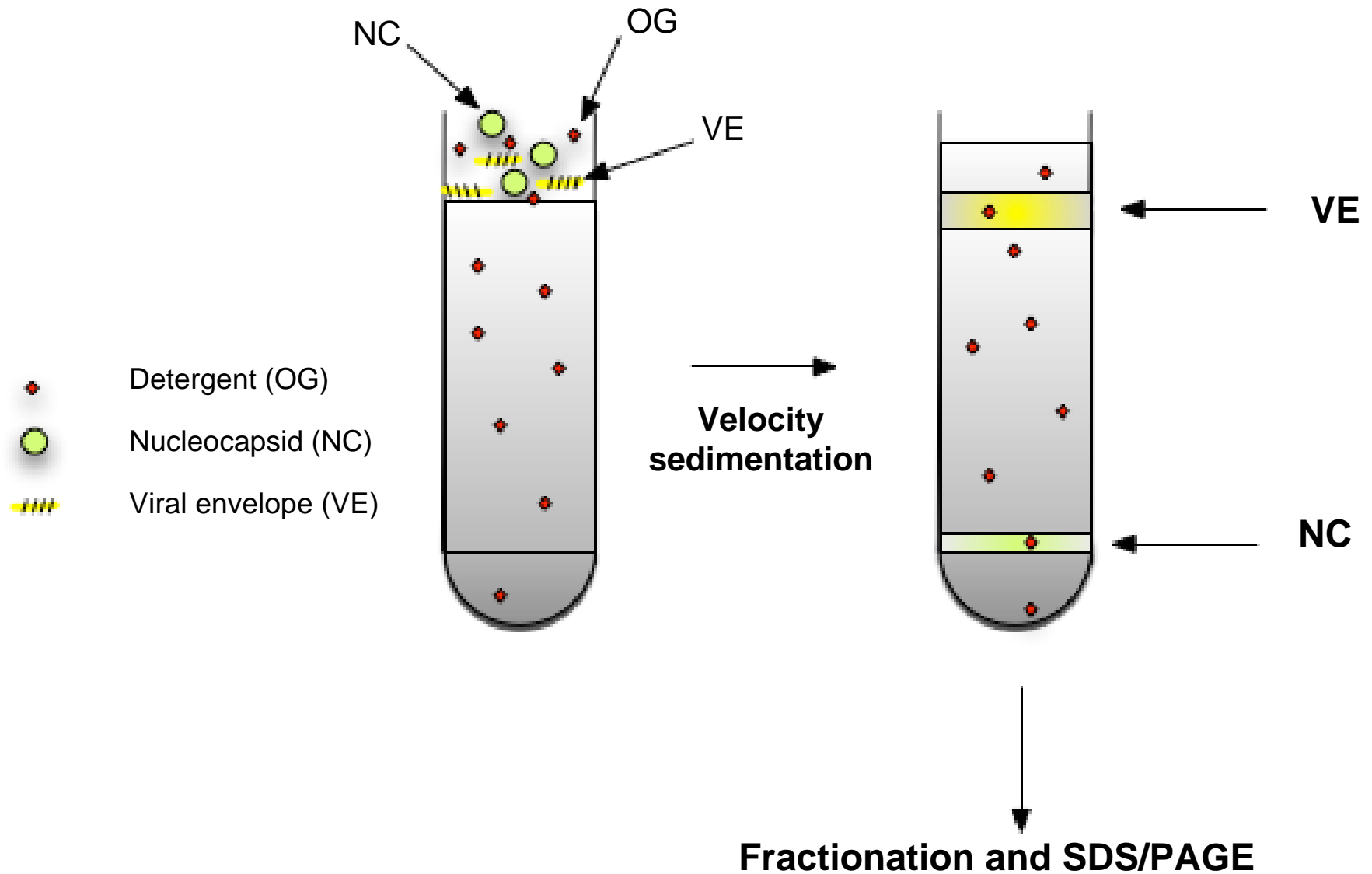

- Can also separate the viral envelopes from nucleocapsids by equilibrium sedimentation
- Mix the purified components on centricons, to rid of detergent and allow intact virions to reform
- Show that infectious particles have been reconstituted from *non*-infectious components

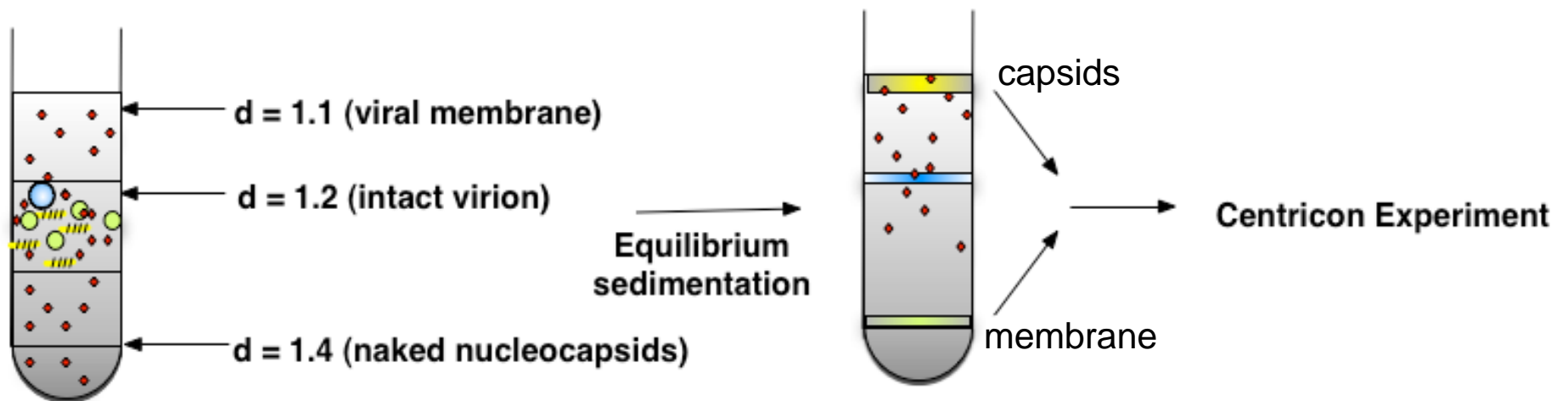

Determine number of infectious virions before and after detergent treatment, and then after detergent removal

Plaque assay: allows us to count *individual* infectious virions

Plaque: a region of infected cells, detectable by naked eye

Substrate: a monolayer of host (2-day-old BHK) cells

Need to be able to count the cells that are infected:
serial (powers of ten) dilutions lead to small (distinct, and hence countable) numbers (1's, 10's, 100's) of infectious virions (hence infected cells: plaques) per plate

Only interested in the number of infected cells that were *initially* infected by the virus: agarose is added to decrease the mobility of the virions in the medium

Plaques are visualized by a stain

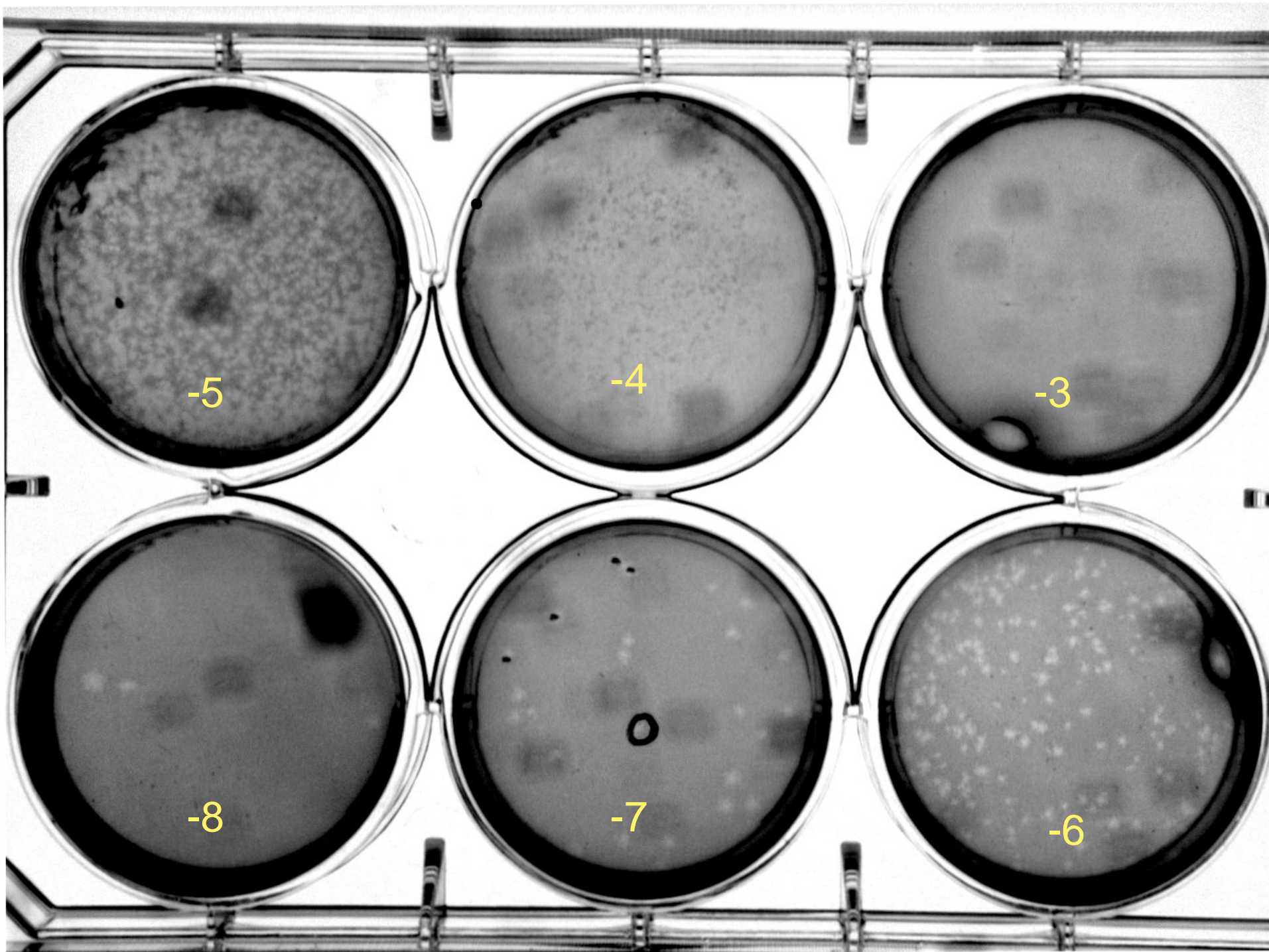



Control Detergent-treated sample Detergent-treated sample unfiltered Unfiltered control

Concentrate and wash away the detergent x5

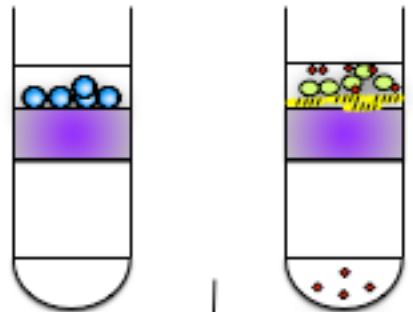

Incubate

Plaque assay:

$\sim 10^8$ pfu/mL

$\sim 10^4$ pfu/mL

Partial recovery !!!

Zero

$\sim 10^8$ pfu/mL

Future experiments

- Structural studies of the infectious particles by EM
- Sedimentation studies of infectious particles formed after Centricon experiment
- Increase the yield of recovery by concentrating the components:

**Make NCs in vitro and add them to the reaction
(taking advantage of the special Sindbis genome...)**

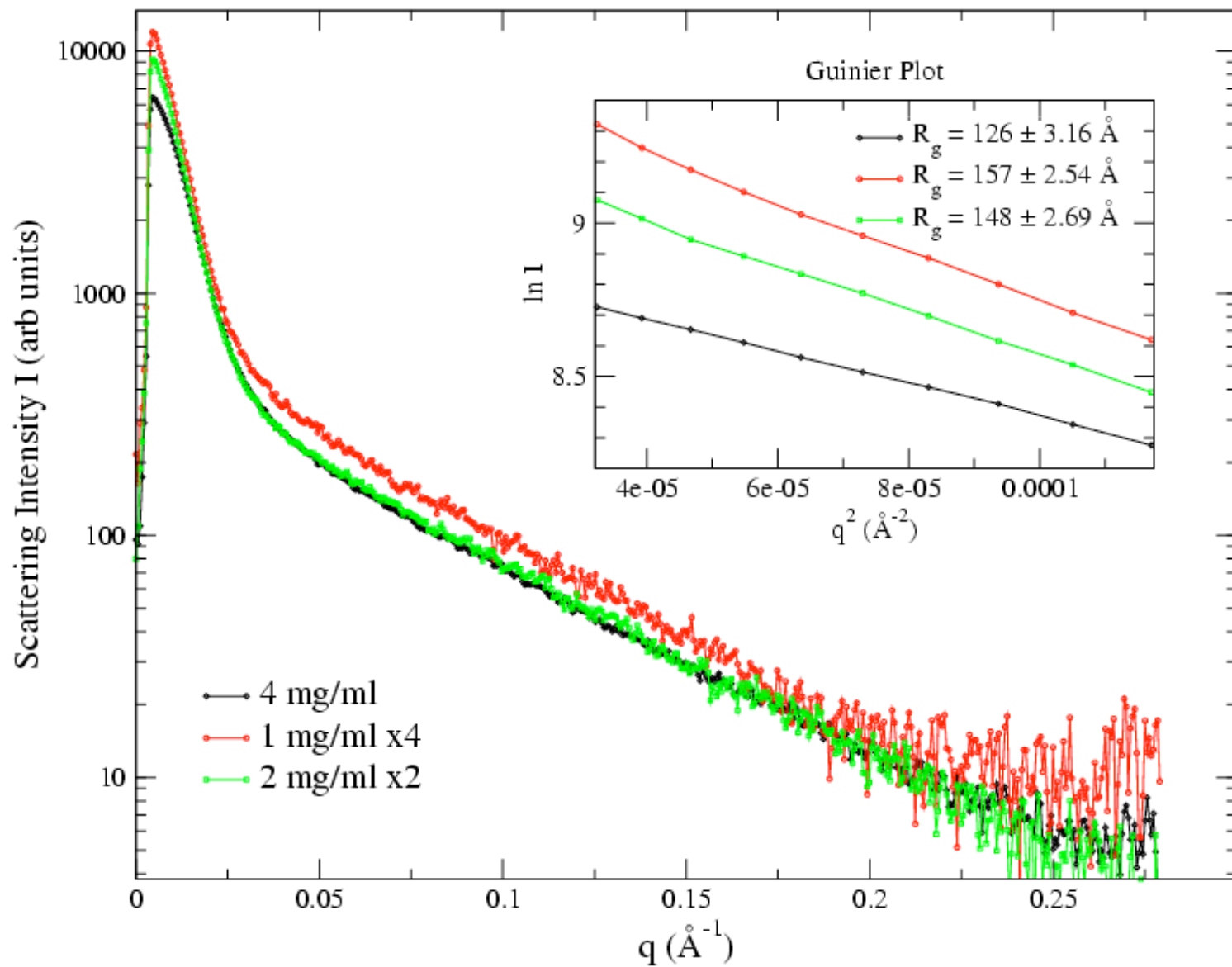

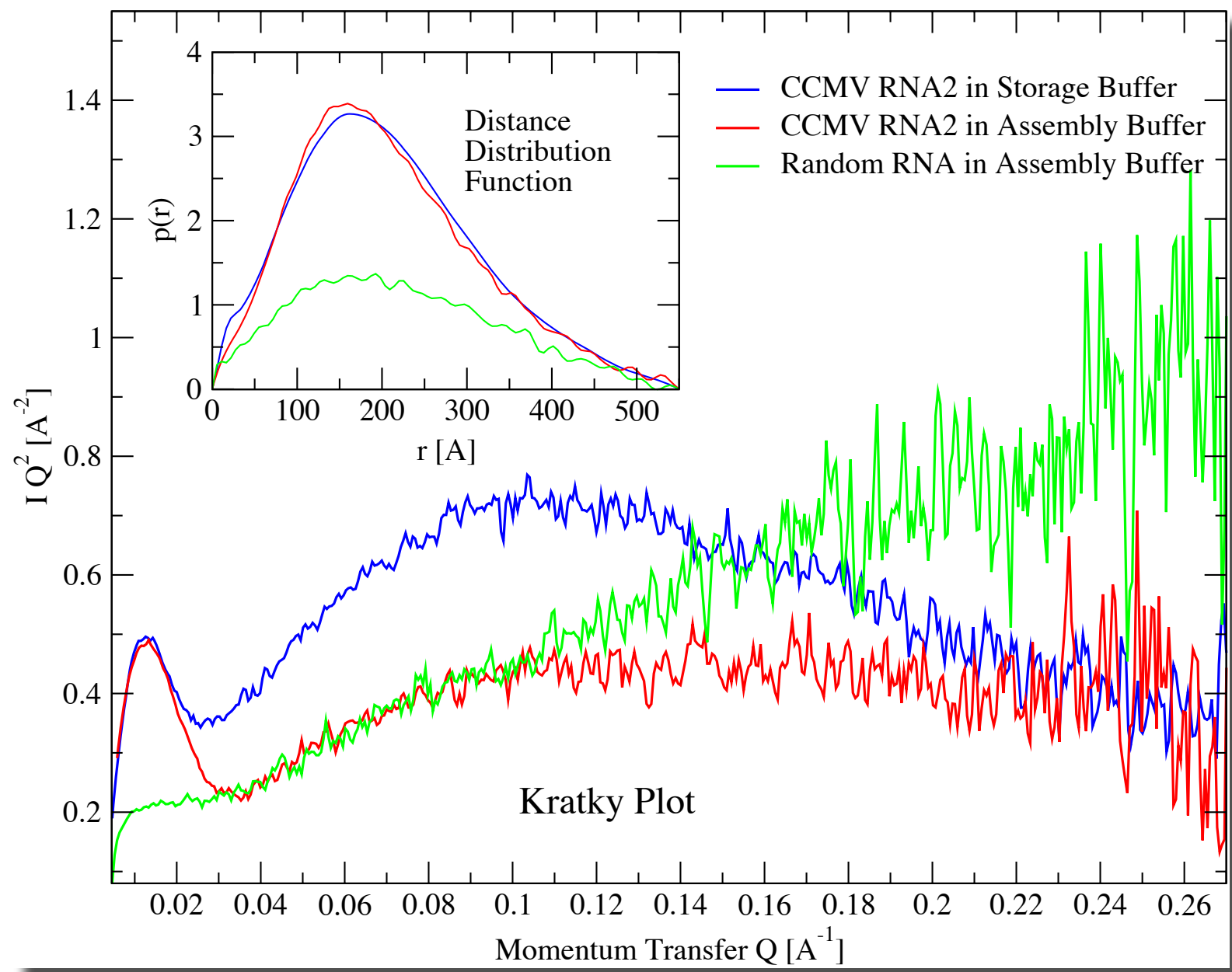

Selected 2117nt-long sequences from 500 chosen at random from 1M bps of the yeast (*S. cerevisiae*) Chromosome 12, some including no coding regions, some fully coding, and most mixed (i.e., introns + exons from different genes)

RNA	First nt# (ChrXII)	Last nt#	GC Fraction	Max. Ladder Dist.	%nt paired
R22	GG+855700	857814	0.351	266	60.56
LD326	688026	690142	0.324	368	61.88
SC326	687701	689817	0.326	347	63.01
LD414	874322	876438	0.427	148	58.10
SC414	874269	876385	0.427	182	59.04
NC1	449324	451440	0.342	236	56.49
NC2	390695	392811	0.402	197	59.23
FC1	352947	355063	0.368	215	57.81
B3E	na	na	0.478	183	61.69
B3R	na	na	0.478	185	64.45

Length-(Nucleotide-)Dependence of RNA Size and Shape

Make “added-length” mutants of 2117 nt-long BMV genes 3 + 4

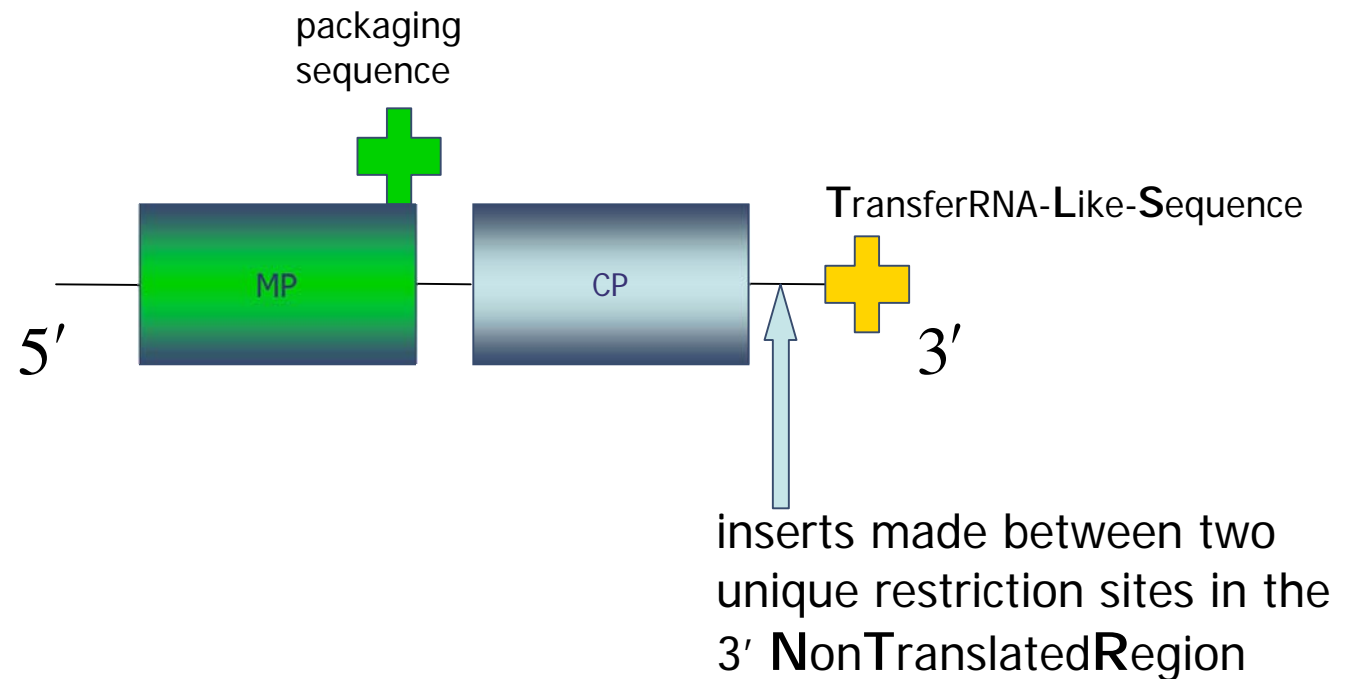

Measure R_g (and *in vitro* and *in vivo* packaging efficiencies...)

YEAST SEGMENTS WITH MIN. MAX LADDER DISTANCE		
position	max ladder	%pairing
325	139	49.60
378	141	52.05
219	142	54.61
414	148	58.10
210	153	55.08
274	154	51.68
6	156	44.40
YEAST SEGMENTS WITH MAXIMUM MAX. LADDER DISTANCE		
position	max ladder	%pairing
326	368	61.88
319	335	59.42
440	335	58.57
199	325	58.48
63	324	60.46
	max. ladder	stdev
AVERAGE YEAST	239.0	38.9
position	max ladder	%pairing
BMV3-ENGINEERED	183	61.69
BMV3-REVERSE	185	62.45
RANDOM-2117	266	60.56
AVERAGE RANDOM (calc'd)	236	~61

maximum ladder distances (MLDs) of selected 2117-nt sequences from Yeast Chromosome 12

average yeast MLD \approx

average random MLD

Kratky Plot

